



# SmartCell Gateway 200/Virtual SmartZone High-Scale for Release 3.4.1

## Administrator Guide

Part Number: 800-71377-001  
Published: 31 January 2017

# Contents

Copyright Notice and Proprietary Information	
Document Conventions	
Documentation Feedback	
Online Training Resources	

## 1 Navigating the Web Interface

Setting Up the Controller for the First Time.....	19
Logging On to the Web Interface.....	19
Web Interface Features.....	20
Main Menu.....	21
Submenu.....	22
Sidebar.....	22
Content Area.....	22
Miscellaneous Bar.....	22
Using Widgets on the Dashboard.....	23
Widgets That You Can Display.....	23
Widget Slots.....	24
Adding a Widget.....	25
Adding a Widget to a Widget Slot.....	26
Displaying a Widget in a Widget Slot.....	27
Moving a Widget.....	28
Deleting a Widget.....	28
Changing the Administrator Password.....	29
Logging Off the Web Interface.....	30

## 2 Managing Ruckus Wireless AP Zones

Working with AP Zones.....	31
Using the Domain Tree.....	31
Creating an AP Zone.....	32
Cloning an AP Zone from the Domain Tree.....	42
Cloning an AP Zone from the AP Zone List.....	42
Viewing Existing AP Zones.....	43
Viewing the AP Zone Configuration.....	43
Deleting an AP Zone.....	44

Working with AP Groups.....	45
Creating an AP Group.....	45
Working with AAA Servers.....	55
Creating an AAA Server.....	55
Testing an AAA Server.....	57
Deleting an AAA Server.....	58
Working with Hotspot (WISPr) Portals.....	58
Creating a Hotspot Portal.....	59
Deleting a Hotspot Portal.....	61
Working with Guest Access Portals.....	62
Creating a Guest Access Portal.....	62
Viewing Guest Access Portals.....	63
Deleting Guest Access Portals.....	64
Working with Web Authentication Portals.....	64
Adding an AAA Server for the Web Authentication Portal.....	65
Creating a Web Authentication Portal.....	65
Creating a WLAN for the Web Authentication Portal.....	66
Working with Hotspot 2.0 Services.....	67
Working with WLANs and WLAN Groups.....	68
Creating a WLAN.....	68
Working with WLAN Groups.....	80
Working with WLAN Schedules.....	83
Creating a WLAN Schedule Profile.....	83
Working with Device Policies.....	84
Creating a Device Access Policy.....	85
Viewing Device Access Policies.....	86
Deleting Device Access Policies.....	86
Working with L2 Access Control Policies.....	87
Creating an L2 Access Policy.....	87
Viewing L2 Access Policies.....	88
Deleting L2 Access Policies.....	88
Working with Bonjour Policies.....	89
Creating a Bonjour Gateway Rule on the AP.....	89
Applying a Bonjour Policy to an AP.....	91
Creating a DiffServ Profile.....	92
Creating an Ethernet Port Profile.....	93
Important Notes About Ethernet Port Profiles.....	96
Working With Dynamic PSKs.....	97
Viewing Dynamic PSKs.....	97

Generating Dynamic PSKs.....	98
Importing Dynamic PSKs.....	98

### 3 Managing Global Configuration, AP Tunnel Profiles, Templates, and AP Registration Rules

Managing Global Configuration.....	101
Creating AP Tunnel Profiles.....	102
Creating a Ruckus GRE Tunnel Profile.....	102
Creating a SoftGRE Tunnel Profile.....	103
Creating an IPsec Profile.....	104
Working with Zone Templates.....	110
Creating and Configuring a Zone Template.....	111
Exporting a Zone Template.....	122
Importing a Zone Template.....	122
Deleting a Zone Template.....	123
Working with WLAN Templates.....	123
Creating and Configuring a WLAN Template.....	124
Viewing Existing WLAN Templates.....	133
Deleting WLAN Templates.....	133
Working with Registration Rules.....	134
Creating a Registration Rule.....	134
Configuring Registration Rule Priorities.....	136
Deleting a Registration Rule.....	136

### 4 Working with 3rd Party AP Zones

3rd Party AP Zone Types.....	138
Adding a 3rd Party AP Zone.....	139
Viewing Existing 3rd Party AP Zones.....	141
Deleting a 3rd Party AP Zone.....	142

### 5 Managing Access Points

Overview of Access Point Configuration.....	143
Viewing Managed Access Points.....	143
Provisioning and Swapping Access Points.....	144
Options for Provisioning and Swapping APs.....	145
Understanding How Swapping Works.....	146
Editing AP Configuration.....	146

Editing Swap Configuration.....	147
Moving a Single Access Point to a Different AP Zone.....	148
Moving Multiple Access Points to a Different AP Zone.....	149
Deleting an Access Point.....	149

## 6 Configuring Services and Profiles

Configuring the GGSN/PGW Service.....	151
Configuring Authentication Services.....	153
Adding an Authentication Service.....	153
Testing the AAA Server Configuration.....	156
Viewing RADIUS Services.....	158
Deleting a Single RADIUS Service.....	158
Deleting Multiple RADIUS Services.....	159
Configuring HLR Services.....	159
Map Gateway Settings.....	159
MNC to NDC Mapping.....	160
Configuring Diameter Services.....	163
Configuring System Wide Settings.....	163
Configuring Remote Peer Settings.....	164
Configuring FTP Services.....	165
Important Notes When Adding FTP Servers.....	166
Configuring Location Services.....	167
Adding an LBS Server.....	167
Configuring the Controller to Use the LBS Server.....	168
Configuring an SMS Server.....	170
Working with Profiles.....	171
Working with Authentication Profiles.....	171
Working with Accounting Profiles.....	175
Working with Hotspot Profiles.....	177
Working with Network Traffic Profiles.....	182
Working with User Traffic Profiles.....	185
Working with DNS Server Services.....	188
Working with Forwarding Profiles.....	189

## 7 Configuring the System Settings

Overview of the System Settings.....	203
Configuring General System Settings.....	203
Setting the System Time.....	203

Configuring the Syslog Server Settings.....	204
Configuring the Northbound Portal Interface.....	207
Configuring the SMTP Server Settings.....	207
Configuring the FTP Server Settings.....	208
Setting Critical AP Auto Tagging Rules.....	209
Configuring Q-in-Q Ether Type.....	210
Managing the Global User Agent Black List.....	210
Configuring SCI Settings.....	211
Enabling and Configuring Node Affinity.....	212
Managing the Certificate Store.....	213
Configuring Advanced Gateway Options.....	218
Configuring Cluster Planes.....	219
Setting the System IP Mode.....	220
Rebalancing APs Across Nodes.....	221
Configuring Control Planes.....	222
Configuring a Data Plane.....	226
Configuring Cluster Redundancy.....	229
Rehoming Managed APs.....	232
Configuring Network Management.....	232
Configuring the SNMPv2 and SNMPv3 Agents.....	232
Sending SNMP Traps and Email Notifications for Events.....	236
Configuring Event Thresholds.....	238
Controlling Access to the Management Interfaces.....	240
Configuring Hosted AAA Services.....	241
EAP-SIM Configuration.....	242
EAP-AKA Configuration.....	243

## 8 Working with Management Domains

Overview of Management Domains.....	245
Viewing a List of Management Domains.....	245
Creating a New Management Domain.....	246
Deleting a Management Domain.....	247
Assigning an Administrator Account to a Role.....	247

## 9 Managing Administrator Accounts

Overview of Administrator Accounts and Roles.....	250
Viewing a List of Administrator Accounts, Roles, and RADIUS Servers.....	250
Creating an Administrator Account.....	252

Creating a New Administrator Role.....	252
Editing an Administrator Role.....	253
Cloning an Existing Administrator Role.....	254
Adding a RADIUS Server for Administrators.....	254
About TACACS+ Support.....	255
Using a Backup RADIUS Server.....	256
Testing an AAA Server.....	259
Deleting an Administrator Account, Role, or RADIUS Server.....	260

## 10 Managing Mobile Virtual Network Operator Accounts

Overview of Mobile Virtual Network Operator Accounts.....	261
Viewing a List of MVNOs.....	261
Creating a New MVNO Account.....	262
Using a Backup RADIUS Server for Authorizing and Authenticating MVNOs.....	265
Editing an MVNO Account.....	265
Deleting an MVNO Account.....	266

## 11 Creating and Managing Hotspots

Overview of Hotspot Management.....	267
Hotspot Terminologies.....	267
How Hotspot Authentication Works.....	268
Call Flow for Devices That Use a Web Proxy.....	271
Devices Using a Static Web Proxy.....	273
Devices Using a Dynamic Web Proxy.....	274
User Agent Blacklist.....	274
Notes on Using iOS Devices to Access the Hotspot.....	275
Notes on Using Amazon Kindle Fire to Access the Hotspot.....	275
What You Will Need.....	276
Hotspot Configuration Options.....	276
Why Create a User Defined Interface.....	276
Creating a User Defined Interface.....	277
Adding a RADIUS Server to the Controller.....	278
Creating a Hotspot WLAN.....	279
Creating a WLAN.....	280
Downloading Captive Portal and Subscriber Portal Logs.....	281

## 12 Monitoring AP Zones, Access Points, and Wireless Clients

Monitoring AP Zones.....	283
Viewing a Summary of AP Zones.....	283
Exporting the AP Zone List to CSV.....	285
Viewing the Configuration of an AP Zone.....	286
Viewing All APs That Belong to an AP Zone on Google Maps.....	287
Monitoring Managed Access Points.....	287
Viewing a Summary of Access Points.....	287
Exporting the Access Point List to CSV.....	290
Viewing the Configuration of an Access Point.....	290
Downloading the Support Log from an Access Point.....	291
Restarting an Access Point Remotely.....	292
Running Ping and Traceroute on an Access Point.....	293
Monitoring Wireless Clients.....	294
Viewing a Summary of Wireless Clients.....	294
Exporting the Wireless Client List to CSV.....	296
Viewing Information About a Wireless Client.....	297
Measuring Wireless Network Throughput with SpeedFlex.....	298

## 13 Monitoring the System, Alarms, Events, and Administrator

### Activity

Monitoring the Controller System.....	300
Viewing the <b>System Cluster Overview</b> .....	300
Displaying the Chassis View of Cluster Nodes.....	301
Starting the <b>Cluster Real-time Monitor</b> .....	302
Monitoring Rogue Access Points.....	303
Viewing Alarms.....	304
Using the Search Criteria Section.....	305
Exporting the Alarm List to CSV.....	306
Clearing Alarms.....	307
Acknowledging Alarms.....	307
Viewing Events.....	307
Using the <b>Search Criteria</b> Section.....	309
Exporting the Event List to CSV.....	310
Viewing Administrator Activity.....	311
Using the Search Criteria Section.....	312
Exporting the Administrator Activity List to CSV.....	313



## 14 Working with Reports

Types of Reports.....	315
Active TTG Sessions Report.....	315
Client Number Report.....	315
Client Number vs Airtime Report.....	315
Continuously Disconnected APs Report.....	316
Failed Client Associations Report.....	316
New Client Associations Report.....	316
System Resource Utilization Report.....	316
TX/RX Bytes Report.....	316
Creating a New Report.....	316
Step 1: Define the General Report Details.....	317
Step 2: Define the Resource Filter Criteria.....	317
Step 3: Define the Time Filter.....	318
Step 4: Define the Report Generation Schedule.....	319
Step 5: Enable Email Notifications (Optional).....	319
Step 6: Export the Report to an FTP Server (Optional).....	320
Step 7: Save the Report.....	320
Viewing a List of Existing Reports.....	320
Deleting a Report.....	321

## 15 Working with Local, Guest, and Remote Users

Working with Local, Guest, and Remote Users.....	322
Working with Local Users.....	322
Working with Guest Users.....	324
Working with User Roles.....	337
Creating a User Role.....	337
Managing Subscription Packages.....	337
Viewing a List of Subscription Packages.....	338
Creating a Subscription Package.....	338
Editing a Subscription Package.....	339
Deleting a Subscription Package.....	340

## 16 Performing Administrative Tasks

Backing Up and Restoring Clusters.....	341
Creating a Cluster Backup.....	341

Restoring a Cluster Backup.....	342
Deleting a Cluster Backup.....	344
Backing Up and Restoring the Controller's Network Configuration from an FTP	
Server.....	345
Backing Up to an FTP Server.....	345
Restoring from an FTP Server.....	347
Backing Up and Restoring System Configuration.....	352
Creating a System Configuration Backup.....	352
Exporting the Configuration Backup to an FTP Server Automatically.....	353
Scheduling a Configuration Backup.....	354
Downloading a Copy of the Configuration Backup.....	355
Restoring a System Configuration Backup.....	356
Deleting a Configuration Backup.....	357
Resetting a Node to Factory Settings.....	358
What Happens After Reset to Factory Settings.....	358
Using the Web Interface.....	358
Using the CLI.....	359
Upgrading the Controller.....	360
Performing the Upgrade.....	360
Verifying the Upgrade.....	364
Rolling Back to a Previous Software Version.....	364
Recovering a Cluster from an Unsuccessful Upgrade.....	365
Uploading AP Patch Files.....	366
Working with Logs.....	367
Available System Log Types.....	367
Downloading All Logs.....	369
Downloading Snapshot Logs Generated from the CLI.....	370
Managing AP Certificate Replacement.....	371
Viewing AP Certificate Status .....	372
Exporting AP Certificate Requests.....	372
Requesting AP Certificate Renewal.....	374
Importing AP Certificate Responses.....	375
Confirming AP Certification Status.....	378
Managing Licenses.....	379
Default Licenses.....	380
Viewing Installed Licenses.....	381
Viewing License Summary.....	381
Configuring the License Server.....	382
Importing License Files.....	383

Downloading Licenses.....	384
Synchronizing Controller with the License Server.....	385

## Appendix A: Overview of the Captive Portal

Configuring the Captive Portal.....	387
Configuring the GGSN/PGW Service.....	387
Configuring an Authentication Profile.....	389
Configuring an Accounting Profile.....	392
Configuring TTG+PDG Forwarding Profiles.....	394
Configuring the WISPr (Hotspot) Services of an AP Zone.....	396
AP Zone WLAN Services & Group.....	398
Captive Portal Workflows and VSA.....	401
Successful Captive Portal Authentication.....	401
Successful GTP Tunnel Establishment.....	402
Ruckus Wireless VSAs for the Captive Portal.....	403

## Appendix B: Statistics Files the Controller Exports to an FTP Server

AP Inventory.....	405
Control Plane Statistics.....	408
Mobility Zone Inventory.....	408
Zone Statistics.....	409
AP Statistics.....	410
Zone Time Radio Statistics.....	411
Zone Time WLAN Statistics.....	412
AP Time Radio Statistics.....	413
AP Time WLAN Statistics.....	414
Control Plane Statistics.....	415
Data Plane Statistics.....	420
Data Plane Ethernet Port Statistics.....	420
AP SoftGRE Tunnel Statistics.....	421
SoftGRE Gateway Statistics.....	422
Tenant Time Radio Statistics.....	423
Tenant Time WLAN Statistics.....	424
Tenant Zone Statistics.....	425
Tenant Zone Radio Statistics.....	427
Tenant Inventory File.....	428

## Appendix C: AP-SCG/SZ/vSZ/vSZ-D Communication

## Appendix D: SoftGRE Support

Overview of SoftGRE Support.....	434
Supported Deployment Scenario.....	434
SoftGRE Packet Format.....	435
Configuring SoftGRE.....	436
Monitoring SoftGRE.....	437
SoftGRE SNMP MIBs.....	439
SoftGRE Alarms and Events.....	439

## Appendix E: Replacing Hardware Components

Installing or Replacing Hard Disk Drives.....	443
Ordering a Replacement Hard Disk.....	443
Removing the Front Bezel.....	443
Removing an HDD Carrier from the Chassis.....	444
Installing a Hard Drive in a Carrier.....	445
Reinstalling the Front Bezel.....	448
Replacing PSUs.....	449
Replacing System Fans.....	449

## Appendix F: Replacing a Controller Node

Backing Up and Restoring the Cluster.....	452
Step 1: Back Up the Cluster from the Web Interface.....	452
Step 2: Back Up the Cluster from the Controller CLI.....	452
Step 3: Transfer the Cluster Backup File to an FTP Server.....	453
Step 4: Restoring the Cluster Backup to the Controller.....	454
Backing Up and Restoring Configuration.....	457
Backed Up Configuration Information.....	457
Backing Up Configuration.....	458
Restoring Configuration.....	458

## Appendix G: SCG SSID Syntax

SSIDs Supported in Release 1.1.x.....	462
SSIDs Supported in Release 2.1.x.....	463

SSIDs Supported in Release 2.5.x.....	463
SSIDs Supported in Release 3.0 and Above.....	464
ZoneDirector SSID Syntax.....	464
SSIDs Supported in Releases 9.8 and 9.7.....	464
Supported SSIDs in ZoneFlex Release 9.6.....	465
ZoneFlex AP SSID Syntax.....	465
Supported SSIDs in Releases 9.8, 9.7, and 9.6.....	465

# Copyright Notice and Proprietary Information

Copyright 2016. Ruckus Wireless, Inc. All rights reserved.

No part of this documentation may be used, reproduced, transmitted, or translated, in any form or by any means, electronic, mechanical, manual, optical, or otherwise, without prior written permission of Ruckus Wireless, Inc. (“Ruckus”), or as expressly provided by under license from Ruckus.

## **Destination Control Statement**

Technical data contained in this publication may be subject to the export control laws of the United States of America. Disclosure to nationals of other countries contrary to United States law is prohibited. It is the reader’s responsibility to determine the applicable regulations and to comply with them.

## **Disclaimer**

THIS DOCUMENTATION AND ALL INFORMATION CONTAINED HEREIN (“MATERIAL”) IS PROVIDED FOR GENERAL INFORMATION PURPOSES ONLY. RUCKUS AND ITS LICENSORS MAKE NO WARRANTY OF ANY KIND, EXPRESS OR IMPLIED, WITH REGARD TO THE MATERIAL, INCLUDING, BUT NOT LIMITED TO, THE IMPLIED WARRANTIES OF MERCHANTABILITY, NON-INFRINGEMENT AND FITNESS FOR A PARTICULAR PURPOSE, OR THAT THE MATERIAL IS ERROR-FREE, ACCURATE OR RELIABLE. RUCKUS RESERVES THE RIGHT TO MAKE CHANGES OR UPDATES TO THE MATERIAL AT ANY TIME.

## **Limitation of Liability**

IN NO EVENT SHALL RUCKUS BE LIABLE FOR ANY DIRECT, INDIRECT, INCIDENTAL, SPECIAL OR CONSEQUENTIAL DAMAGES, OR DAMAGES FOR LOSS OF PROFITS, REVENUE, DATA OR USE, INCURRED BY YOU OR ANY THIRD PARTY, WHETHER IN AN ACTION IN CONTRACT OR TORT, ARISING FROM YOUR ACCESS TO, OR USE OF, THE MATERIAL.

## **Trademarks**

Ruckus Wireless, Ruckus, the bark logo, BeamFlex, ChannelFly, Dynamic PSK, FlexMaster, Simply Better Wireless, SmartCell, SmartMesh, SmartZone, Unleashed, ZoneDirector and ZoneFlex are trademarks of Ruckus Wireless, Inc. in the United States and other countries. All other product or company names may be trademarks of their respective owners.

# Document Conventions

Table 1: Text conventions on page 15 and Table 2: Notice conventions on page 15 list the text and notice conventions that are used throughout this guide.

**Table 1: Text conventions**

Convention	Description	Example
message phrase	Represents messages displayed in response to a command or a status	[Device Name] >
user input	Represents information that you enter	[Device Name] > set ipaddr 10.0.0.12
user interface controls	Keyboard keys, software buttons, and field names	Click <b>Create New</b>
<b>Start &gt; All Programs</b>	Represents a series of commands, or menus and submenus	Select <b>Start &gt; All Programs</b>
<b>ctrl+V</b>	Represents keyboard keys pressed in combination	Press <b>ctrl+V</b> to paste the text from the clipboard.
screen or page names		Click <b>Advanced Settings</b> . The <b>Advanced Settings</b> page appears.
command name	Represents CLI commands	
parameter name	Represents a parameter in a CLI command or UI feature	
variable name	Represents variable data	{ZoneDirectorID}
filepath	Represents file names or URI strings	http://ruckuswireless.com

**Table 2: Notice conventions**

Notice type	Description
<b>NOTE:</b>	Information that describes important features or instructions
<b>CAUTION:</b>	Information that alerts you to potential loss of data or potential damage to an application, system, or device

Notice type	Description
<b>WARNING:</b>	Information that alerts you to potential personal injury



# Documentation Feedback

Ruckus Wireless is interested in improving its documentation and welcomes your comments and suggestions.

You can email your comments to Ruckus Wireless at: [docs@ruckuswireless.com](mailto:docs@ruckuswireless.com)

When contacting us, please include the following information:

- Document title
- Document part number (on the cover page)
- Page number (if appropriate)

## Online Training Resources

To access a variety of online Ruckus Wireless training modules, including free introductory courses to wireless networking essentials, site surveys, and Ruckus Wireless products, visit the Ruckus Wireless Training Portal at:

<https://training.ruckuswireless.com>.

# Navigating the Web Interface

In this chapter:

- [Setting Up the Controller for the First Time](#)
- [Logging On to the Web Interface](#)
- [Web Interface Features](#)
- [Using Widgets on the Dashboard](#)
- [Changing the Administrator Password](#)
- [Logging Off the Web Interface](#)

In this chapter:

**NOTE:** Before continuing, make sure that you have already set up the controller on the network as described in the Getting Started Guide or Quick Setup Guide for your controller platform.

Some of the new features (for example, location based services, rogue AP detection, force DHCP, and others) that this guide describes may not be visible on the controller web interface if the AP firmware deployed to the zone you are configuring is earlier than this release. To ensure that you can view and configure all new features that are available in this release, Ruckus Wireless recommends upgrading the AP firmware to the latest version.

## Setting Up the Controller for the First Time

For information on how to set up the controller for the first time, including instructions for running and completing the controller's Setup Wizard, see the *Getting Started Guide* or *Quick Setup Guide* for your controller platform.

## Logging On to the Web Interface

Before you can log on to the controller web interface, you must have the IP address that you assigned to the Management (Web) interface when you set up the controller on the network using the Setup Wizard.

Once you have this IP address, you can access the web interface on any computer that can reach the Management (Web) interface on the IP network.

Follow these steps to log on to the controller web interface.

1. On a computer that is on the same subnet as the Management (Web) interface, start a web browser. Supported web browsers include:
  - Google Chrome 15 (and later) - recommended
  - Microsoft Internet Explorer 9.0
  - Safari 5.1.1 (and later)

- Mozilla Firefox 8 (and later)
2. In the address bar, type the IP address that you assigned to the Management (Web) interface, and then append a colon and 8443 (the controller's management port number) at the end of the address.

For example, if the IP address that you assigned to the Management (Web) interface is 10.10.101.1, then you should enter: `https://10.10.101.1:8443`

**NOTE:** The controller web interface requires an HTTPS connection. You must append `https` (not `http`) to the management interface IP address to connect to the web interface. If a browser security warning appears, this is because the default SSL certificate (or security certificate) that the controller is using for HTTPS communication is signed by Ruckus Wireless and is not recognized by most web browsers.

The controller web interface logon page appears.



**Figure 1: The controller's logon page**

3. Log on to the controller web interface using the following logon details:
  - User Name: admin
  - Password: {the password that you set when you ran the Setup Wizard}
4. Click Log On.

The web interface refreshes, and then displays the Dashboard, which indicates that you have logged on successfully.

## Web Interface Features

Use the web interface to manage the controller and the APs that provide wireless service to users on the network.

The web interface (shown in [Figure 2: The controller web interface features](#) on page 21) is the primary interface that you will use to:

- Manage AP zones, access points, and management domains
- Create and manage administrator and mobile virtual network operator accounts
- Monitor AP zones, managed access points, wireless clients
- View alarms, events, and administrator activity

- Generate reports
- Perform administrative tasks, including backing up and restoring system configuration, upgrading the cluster upgrade, downloading support logs, performing system diagnostic tests, viewing the statuses of controller processes, and uploading additional licenses (among others)
- Configure services and profiles for different network elements, packages, and configurations specific to the controller.

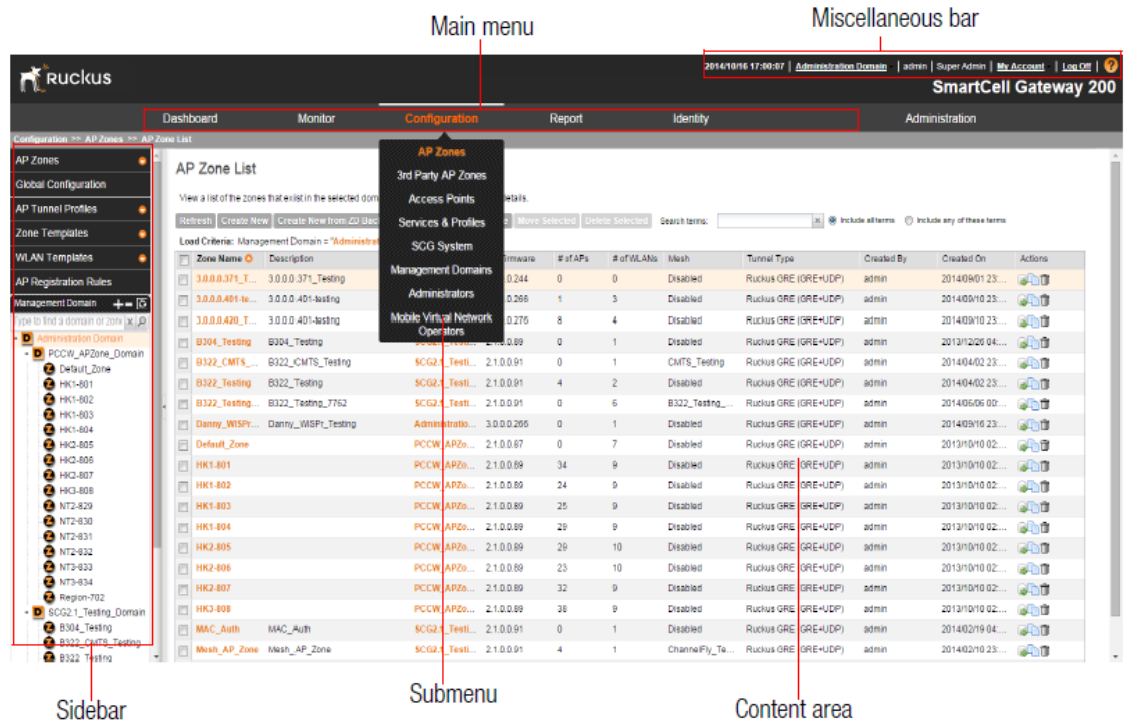


Figure 2: The controller web interface features

The following sections describe the web interface features that are called out in [Figure 2: The controller web interface features](#) on page 21:

## Main Menu

This is the primary navigation menu. The main menu contains six items:

- **Monitor:** Contains options for viewing information about AP zones, access points, wireless clients, system information, alarms, events, and administrator activity.

For more information, see the following topics:

- [Monitoring AP Zones, Access Points, and Wireless Clients](#) on page 283
- [Monitoring the System, Alarms, Events, and Administrator Activity](#) on page 300

- **Configuration:** Contains options for managing AP zones, access points, system settings, management domains, administrator accounts and mobile virtual network administrator accounts.

For more information, see the following topics:

- [Managing Ruckus Wireless AP Zones](#) on page 31
- [Managing Access Points](#) on page 143
- [Configuring Services and Profiles](#) on page 151
- [Configuring the System Settings](#) on page 203
- [Working with Management Domains](#) on page 245
- [Managing Administrator Accounts](#) on page 250
- [Managing Mobile Virtual Network Operator Accounts](#) on page 261
- **Report:** Contains options for generating various types of reports, including network tunnel statistics and historical client statistics. For more information, see [Working with Reports](#) on page 315.
- **Identity:** Contains options for creating and managing profiles and guest passes. For more information, see [Working with Local, Guest, and Remote Users](#) on page 322.
- **Administration:** Contains options for performing administrative tasks, such as backing up and restoring the database, upgrading the system, downloading log files, and performing diagnostic tests. For more information, see [Performing Administrative Tasks](#) on page 341.

## Submenu

The submenu appears when you hover the mouse pointer over the [Main Menu](#) on page 21 items. The submenu provides options related to the main menu item on which you hovered your mouse pointer.

For example, submenu items under the Configuration menu include options for configuring AP zones and access points.

## Sidebar

The sidebar, located on the left side of the [Content Area](#) on page 22, provides additional options related to the submenu that you clicked.

For example, sidebar items under **Configuration > AP Zones** include AP zone templates and AP registration rules.

On some pages, the sidebar also includes a tree that you can use to filter the information you want to show in the [Content Area](#) on page 22.


## Content Area

This large area displays tables, forms, and information that are relevant to submenu and sidebar items that you clicked.

## Miscellaneous Bar

This shows the following information (from left to right):


- System date and time: Displays the current system date and time. This is obtained by the controller from the NTP time server that has been configured.
- Management domain link: If there is more than one management domain configured on the controller, click Administration Domain to display all of the existing management domains, and then click the management domain to which you want to switch the web interface. Refer to the following sections for more information:

- Creating a new management domain (see [Working with Management Domains](#) on page 245)
- Adding an administrator account and assigning a role to the account (see [Managing Administrator Accounts](#) on page 250)
- Administrator user name: Displays the user name of the administrator that is currently logged on.
- Administrator role: Displays the administrator role (for example, Super Admin) of the user that is currently logged on.
- My Account link: Clicking this link displays the following links:
  - Change Password link: Click this to change your administrator password. For more information, see [Changing the Administrator Password](#).
  - Preference: Click this link to configure the session timeout settings. In Session Timeout Settings, type the number of minutes (1 to 1440 minutes) of inactivity after which the administrator will be logged off of the web interface automatically.
- : Click this icon to launch the Online Help, which provides information on how to perform management tasks using the web interface.

## Using Widgets on the Dashboard

The dashboard provides a quick summary of what is happening on the controller and its managed access points. It uses widgets to display at-a-glance information about managed access points, AP zones, management domains, client count, domain summary, and system summary, among others.

This section describes the widgets that you can display and how to add, move, and delete widgets from the dashboard.

**NOTE:** To refresh the information on each widget, click  (refresh button) on the upper-right corner of the widget.

### Widgets That You Can Display

There are six types of dashboard widgets that the controller supports. These include:

#### Client Count Summary Widget

The client count summary widget displays a graph of the number of wireless clients that are associated with access points that the controller is managing.

The client count summary widget requires two widget slots.

You can display client count based on the management domain, AP zone, or SSID.

### AP Status Summary Widget

The AP status summary widget includes a pie chart that shows the connection status of managed APs that belong to either a management domain or an AP zone.

You can configure the pie chart to show access point data based on their connection status, model, and mesh role.

The AP status summary widget requires one widget slot.

### Domain Summary Widget

The domain summary widget displays details about the AP zones and access points that belong to the selected management domain.

It shows the AP zones that belong to the management domain, the total number of APs (including their current connection status and mesh status), and current number of clients.

The domain summary widget requires two widget slots.

### System Summary Widget

The system summary widget displays information about the controller system, including the name and version of the cluster, the number and software versions of the control planes and data planes that are installed, and the Wi-Fi controller licenses (consumed versus total).

The system summary widget requires one widget slot.

### Data Throughput Summary Widget

The data throughput summary widget displays a graph of TX and RX throughputs (in Mbps) based on either AP zone or SSID.

The data throughput summary widget requires two widget slots.

### Client OS Type Summary Widget

The client operating system (OS) type summary widget displays a pie chart that shows the types of OS that associated wireless clients are using.

The client OS type summary widget requires one widget slot.

**NOTE:** The default refresh interval for the Client OS Type Summary widget is 15 minutes. When you add the widget, you can configure this refresh interval to any value between 1 and 30 minutes.

## Widget Slots

The controller provides nine slots on the dashboard for placing widgets.

[Figure 3: There are nine slots for widgets on the dashboard](#) on page 25 marks these nine slots on the dashboard.

Note that some widgets are wider (for example, the client count summary and data throughput widgets) and require two widget slots. Make sure that there are enough empty slots on the dashboard before you add or move a widget.



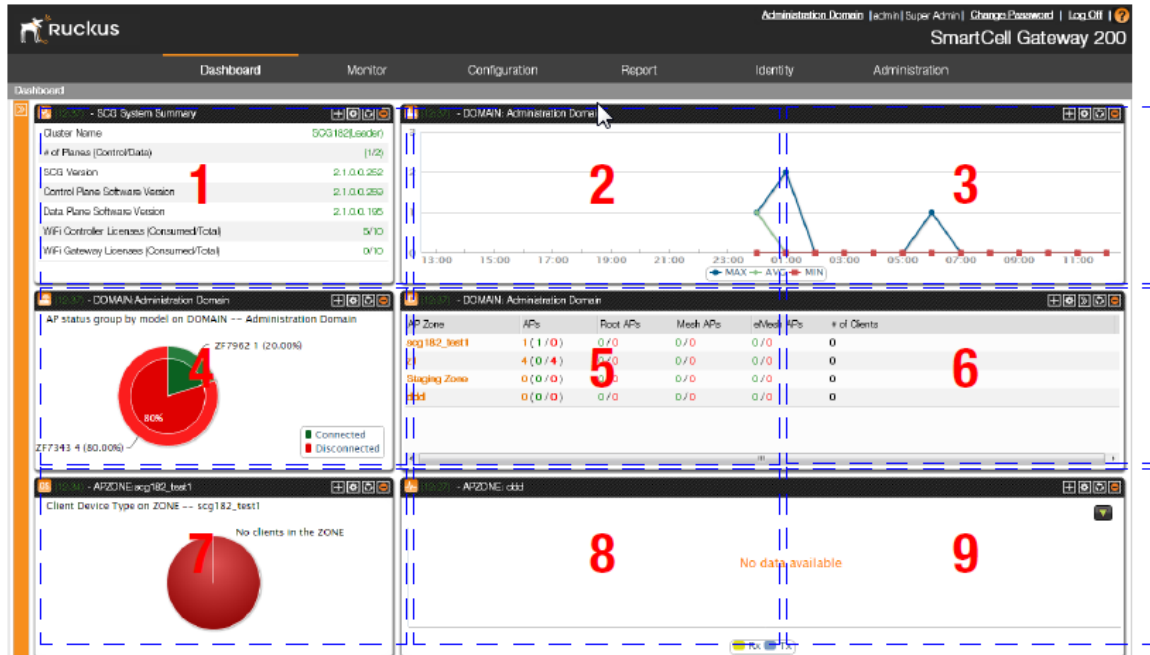


Figure 3: There are nine slots for widgets on the dashboard

### Adding a Widget

Follow these steps to add a widget to the dashboard.








1. Click the  icon in the upper-left corner of the page (below the Ruckus Wireless icon). The icons for adding widgets appear (see [Table 3: Icons for adding widgets](#) on page 25).

Table 3: Icons for adding widgets

Icon	Widget Name
	Client count summary widget
	AP summary widget
	Domain summary widget
	System summary widget
	Traffic summary widget
	Client type summary widget

2. Click the icon for the widget that you want to add.

A configuration form, which contains widget settings that you can configure, appears.

3. Configure the widget settings.
4. Click OK.

The page refreshes, and then the widget that you added appears on the dashboard.

You have completed adding a widget. To add another widget, repeat the same procedure.

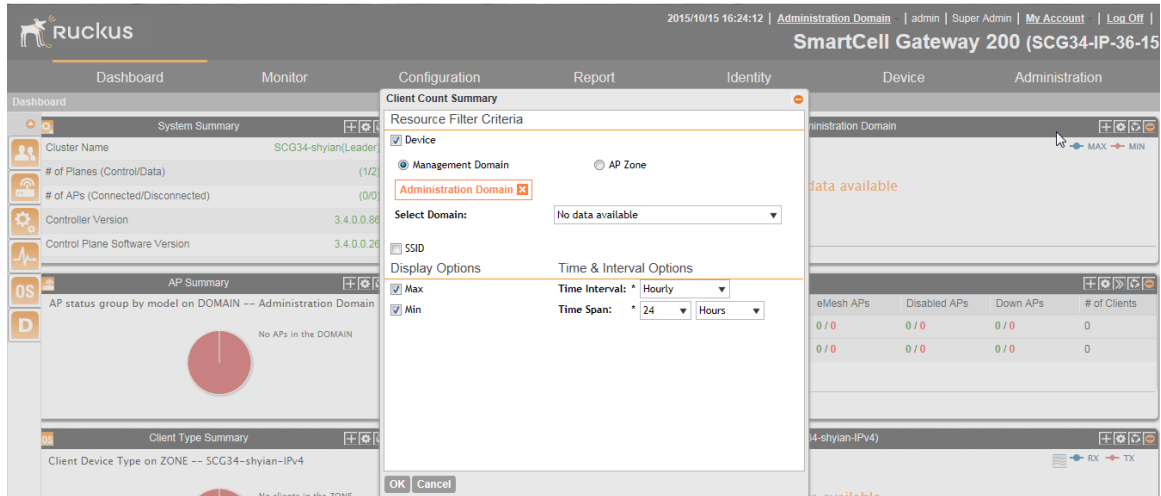



Figure 4: The configuration form for the Client Count Summary widget

### Adding a Widget to a Widget Slot

A single widget slot can contain multiple widgets of the same size (one-slot widgets versus two-slot widgets).

For example, you can add the client count summary widget and data throughput widget (both are two-slot widgets) to the same widget slot.

Follow these steps to add a widget to a widget slot.

1. Locate an existing widget slot to which you want to add a widget.
2. Click the  icon that is on the upper-right hand corner of the widget slot.

A submenu appears and displays the widgets that you can add to the widget slot.

3. Click the name of the widget that you want to add to the widget slot.

The widget configuration window appears.

**NOTE:** You can only add a widget once. If a widget already exists in a different widget slot, you will be unable to add it to another widget slot.

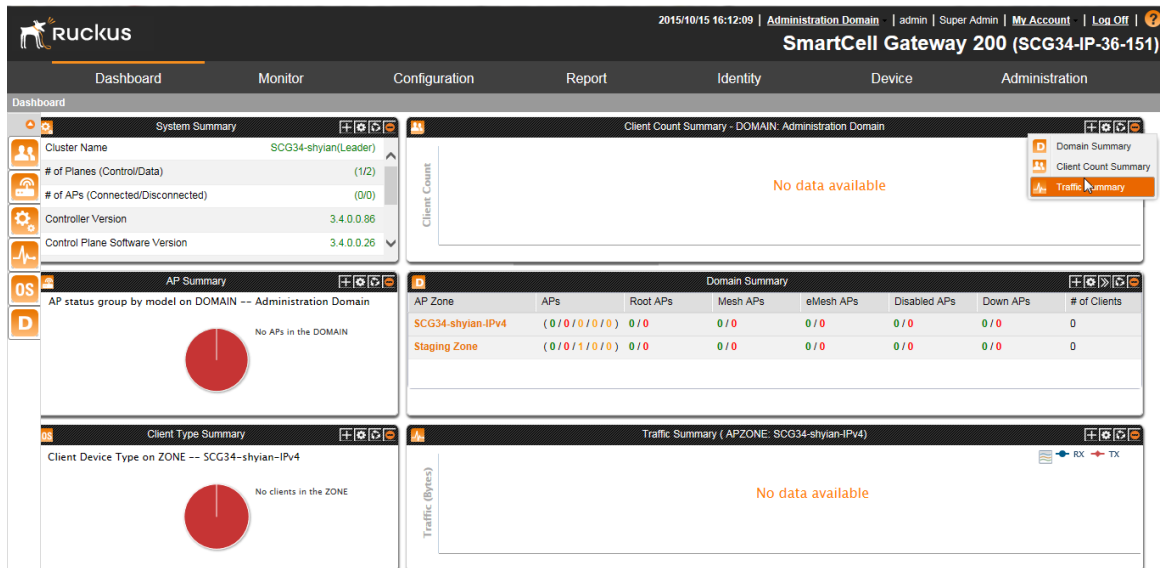
4. Configure the information that you want the widget to display and the interval at which to refresh the information on the widget.

**NOTE:** The refresh intervals for the client count summary and data throughput summary widgets are non-configurable.

5. Click OK.

The widget slot refreshes, and then the widget that you added appears.

You have completed adding a widget to a widget slot.




**Figure 5: Click the name of the widget that you want to add to the widget slot**

### Displaying a Widget in a Widget Slot

A widget slot that contains multiple widgets automatically cycles through the different widgets that have been added to it at one-minute intervals.

If you want to view a specific widget in a widget slot, you can manually display it.

Follow these steps to display a widget that belongs to a widget slot manually.

1. Locate the widget slot that contains the widget that you want to display.
2. Click the  icon that is on the upper-right hand corner of the widget slot.

A submenu appears and displays the widgets that have been added to the widget slot.

3. Click the name of the widget that you want to display.

The widget slot refreshes, and the widget that you clicked appears.

You have completed displaying a widget in a widget slot.

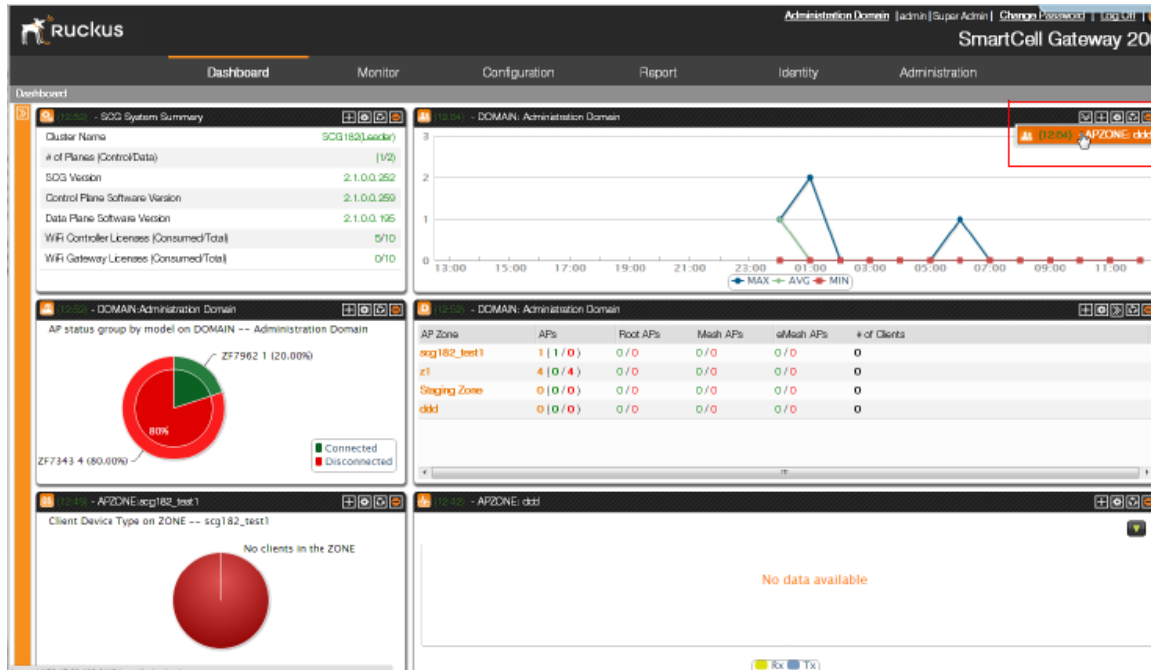


Figure 6: Click the name of the widget that you want to display

## Moving a Widget

Follow these steps to move a widget from one widget slot to another.

1. Make sure that there are sufficient slots for the widget that you want to move.
2. Hover your mouse pointer on the title bar of the widget.


The pointer changes into a four-way arrow.

3. Click-and-hold the widget, and then drag it to the empty slot to which you want to move it.
4. Release the widget.

You have completed moving a widget to another slot.

## Deleting a Widget

Follow these steps to delete a widget.

1. Locate the widget that you want to delete.
2. Click the  icon that is on the upper-right hand corner of the widget.

A confirmation message appears.

3. Click OK to confirm.

The dashboard refreshes, and then the widget that you deleted disappears from the page.

4. Click OK to confirm that you want to delete this widget.

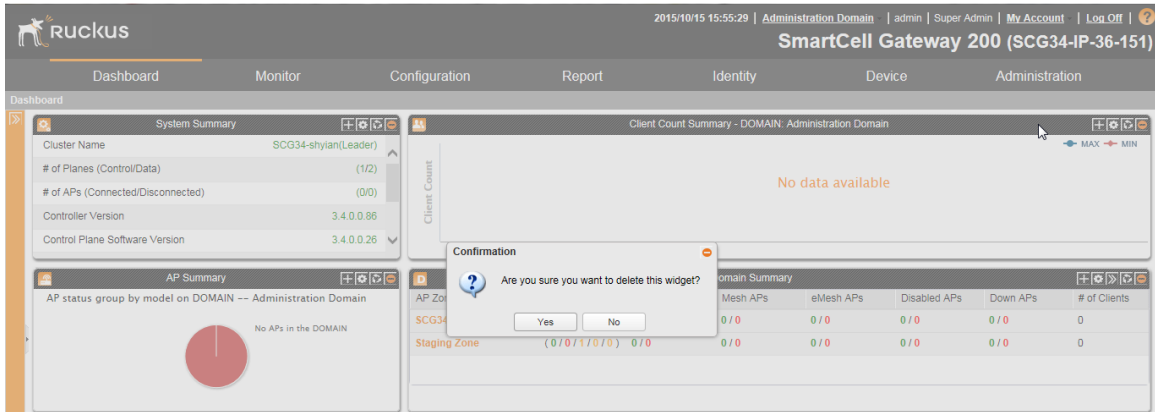


Figure 7: Click Yes to delete the widget

## Changing the Administrator Password

Follow these steps to change the administrator password.

1. On the **Miscellaneous Bar**, click **Change Password**.  
The **Change Password** form appears.
2. In **Old Password**, type your current password.
3. In **New Password**, type the new password that you want to use.
4. In **Confirm Password**, retype the new password above.
5. Click **Change**.

You have completed changing your administrator password. The next time you log on to the controller, remember to use your new administrator password.

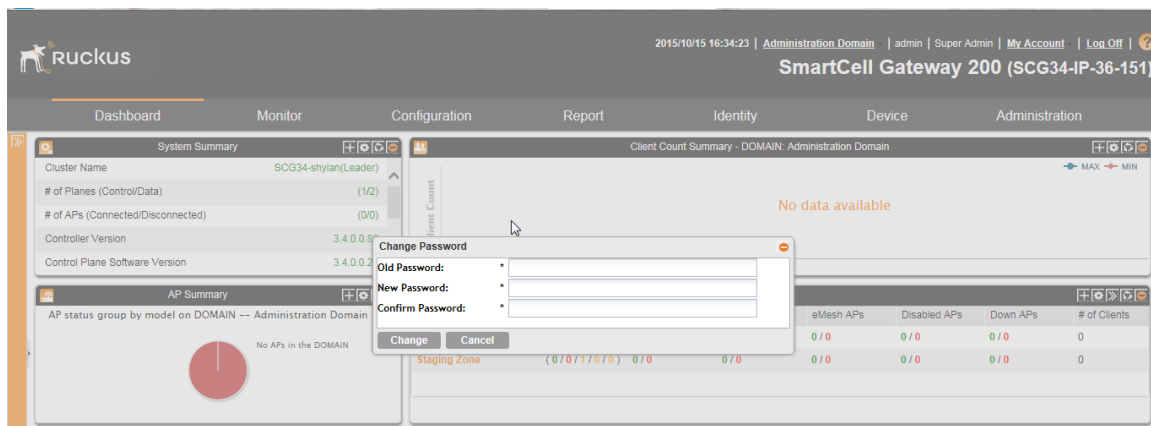


Figure 8: The Change Password form

## Logging Off the Web Interface

Follow these steps to log off the web interface.

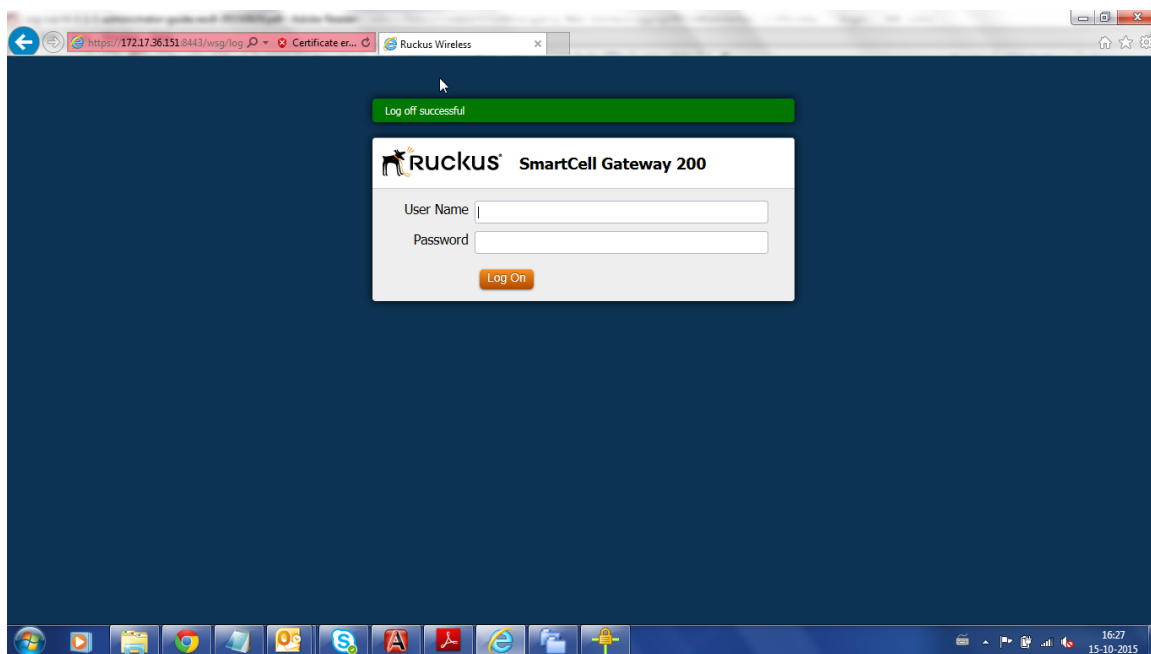
1. On the **Miscellaneous Bar**, click **Log Off**.

A confirmation message appears.

2. Click **Yes**.

The controller logs you off the web interface. The logon page appears with the following message above the Ruckus Wireless logo: `Log off successful`

You have completed logging off the web interface.



**Figure 9:** The message `Log off successful` indicates that you have successfully logged off the web interface

# Managing Ruckus Wireless AP Zones

# 2

In this chapter:

- [Working with AP Zones](#)
- [Working with AP Groups](#)
- [Working with AAA Servers](#)
- [Working with Hotspot \(WISPr\) Portals](#)
- [Working with Guest Access Portals](#)
- [Working with Web Authentication Portals](#)
- [Working with Hotspot 2.0 Services](#)
- [Working with WLANs and WLAN Groups](#)
- [Working with WLAN Schedules](#)
- [Working with Device Policies](#)
- [Working with L2 Access Control Policies](#)
- [Working with Bonjour Policies](#)
- [Creating a DiffServ Profile](#)
- [Creating an Ethernet Port Profile](#)
- [Working With Dynamic PSKs](#)

An AP zone functions as a way of grouping Ruckus Wireless APs and applying a particular set of settings (including WLANs and their settings) to this group of Ruckus Wireless APs. Each AP zone can include up to 27 WLAN services.

## Working with AP Zones

By default, an AP zone named Staging Zone exists. Any AP that registers with the controller that is not assigned a specific zone is automatically assigned to the Staging Zone. This section describes how to use AP zones to manage devices.

**NOTE:** When an AP is assigned or moved to the Staging Zone, the cluster name becomes its user name and password after the AP shows up-to-date state. If you need to log on to the AP, use the cluster name for the user name and password.

Before creating an AP zone, Ruckus Wireless recommends that you first set the default country code on the **Global Configuration** page. This will help ensure that each new AP zone will use the correct country code. For information on how to set the default country code, see [Managing Global Configuration](#) on page 101.

### Using the Domain Tree

Use the domain tree to find APs that you want to manage.

Clicking **Configuration > AP Zones** on the main menu displays a sidebar on the left side of the page, which includes the domain tree.

The domain tree displays the management domains (D) and AP zones (Z) that are under **Administration Domain**. Clicking a domain icon in the tree displays the AP zones that belong to it in the content area. Clicking an AP zone icon, on the other hand, displays detailed information about the AP zone, including its general information, AAA server configuration, and hotspot configuration.

**NOTE:** The search criteria are case-sensitive.

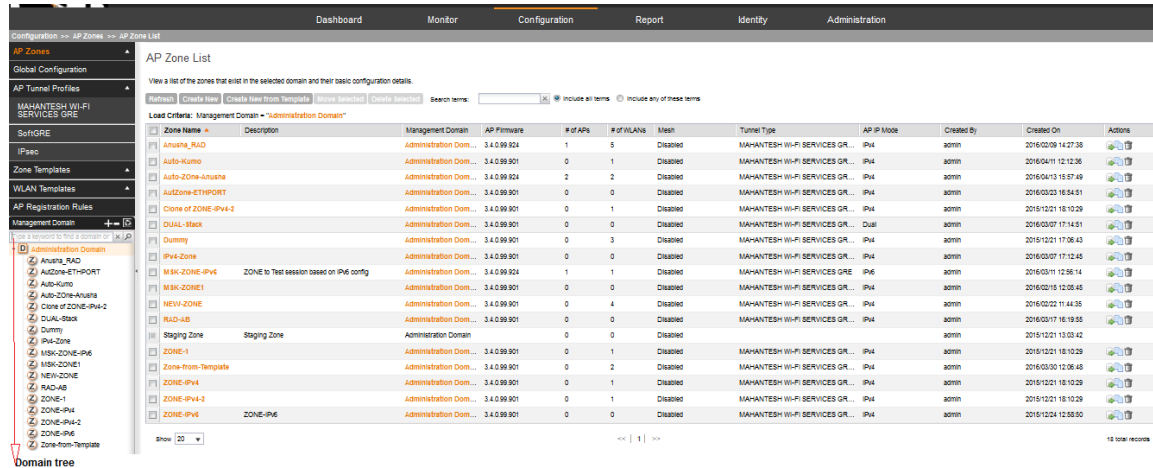


Figure 10: The domain tree

## Creating an AP Zone

An AP zone functions as a way of grouping Ruckus Wireless APs and applying settings including WLANs to these groups of Ruckus Wireless APs. Each AP zone can include up to six WLAN services..

Follow these steps to create an AP zone.

**NOTE:** If you are planning to use SoftGRE tunneling for this AP zone, you must first create a SoftGRE tunnel profile before creating the AP zone. For information on how to create a SoftGRE tunnel profile, [Creating a SoftGRE Tunnel Profile](#) on page 103.

1. Click **Configuration > AP Zones**.
2. Click **Create New**.

The form for creating a new AP zone appears.

3. Configure **General Options**.

Option	Description
<b>Zone Name</b>	Type a name that you want to assign to this new zone.
<b>Description</b>	Type a description for this new zone. This is an optional field.
<b>AP Firmware</b>	Select the AP firmware version that you want the AP zone to use. By default, the latest AP firmware available on the controller is selected.



Option	Description
<b>Country Code</b>	Select the country in which you are operating the access points. Different countries and regions maintain different rules that govern which channels can be used for wireless communications. Setting the country code to the proper regulatory region helps ensure that the wireless network does not violate local and national regulatory restrictions.
<b>Location</b>	Type a location name (for example, Ruckus Wireless HQ) for this AP zone.
<b>Location Additional Information</b>	Type additional information about the AP zone (for example, 350 W Java Dr, Sunnyvale, CA 94089, United States).
<b>GPS Coordinates</b>	Type the latitude, longitude and altitude coordinates for the AP zone's location.
	Specify the user name and password that administrators can use to log on directly to the managed access point's native web interface. The following boxes are provided: <ul style="list-style-type: none"> <li>• <b>Logon ID:</b> Type the admin user name.</li> <li>• <b>Password:</b> Type the admin password.</li> </ul>
<b>Time Zone</b>	Select the time zone that you want APs that belong to this zone to use. Options include: <ul style="list-style-type: none"> <li>• <b>System defined:</b> Click this option, and then select a time zone from the list.</li> <li>• <b>User defined:</b> Click this option, and then configure a custom time zone by setting the time zone abbreviation and GMT offset and configuring daylight saving time support.</li> </ul>
<b>AP IP Mode</b>	Select the IP addressing mode that you want APs (that belong to this zone) to use. Options include: <ul style="list-style-type: none"> <li>• IPv4 Only: choosing this option allows you to perform IPv4 network configuration on the AP zone</li> <li>• IPv6 Only: choosing this option allows you to perform IPv6 network configuration on the AP zone</li> <li>• Dual: choosing this option allows you to perform both IPv4 and IPv6 network configuration on the AP zone</li> </ul>

#### 4. Configure Mesh Options.

Option	Description
<b>Enable mesh networking</b>	Select this check box if you want managed APs to automatically form a wireless mesh network, in which participant nodes (APs) cooperate to route packets.  Dual band APs can only mesh with other dual band APs, while single band APs can only mesh with other single band APs.

Option	Description
<b>Mesh Name (ESSID)</b>	This option only appears when the <b>Enable mesh networking</b> check box above is selected. Type a name for the mesh network. Alternatively, do nothing to accept the default mesh name that the controller has generated.
<b>Mesh Passphrase</b>	This option only appears when the <b>Enable mesh networking</b> check box above is selected. Type a passphrase that contains at least 12 characters. This passphrase will be used by the controller to secure the traffic between Mesh APs. Alternatively, click <b>Generate</b> to generate a random passphrase with 32 characters or more.

## 5. Configure Radio Options.

Option	Description
<b>Channel Range (2.4G)</b>	Select the check boxes for the channels on which you want the 2.4GHz radios of managed APs to operate. Channel options include channels 1 to 11. By default, all channels are selected.
<b>DFS Channels</b>	<p>If the country code that is selected in the <b>General Options</b> section of this page is <b>United States</b>, the <b>Allow DFS channels</b> check boxes appears. Selecting this check box adds Dynamic Frequency Selection (DFS) channels to the list of 5GHz channels (see below) that managed APs can use indoors and outdoors.</p> <p>DFS channels, which are special channels allocated for radar signals, can be used by unlicensed devices (such as APs and wireless clients) if no radar signals are using them. If radar signals are detected on a DFS channel that is currently used by devices, those devices will automatically vacate the channel and use an alternate channel.</p>
<b>Channel Range (5G) Indoor</b>	Select the check boxes for the channels on which you want the 5GHz radios of managed <i>indoor</i> APs to operate. If you selected the <b>Allow DFS channels</b> check box above, the list of channel options includes the DFS channels.
<b>Channel Range (5G) Outdoor</b>	Select the check boxes for the channels on which you want the 5GHz radios of managed <i>outdoor</i> APs to operate. If you selected the <b>Allow DFS channels</b> check box above, the list of channel options includes the DFS channels.
<b>Radio Options b/g/n (2.4 GHz)</b>	<p>Configure the following options:</p> <ul style="list-style-type: none"> <li>• <b>Channelization:</b> Set the channel width used during transmission to either <b>20</b> or <b>40</b> (MHz), or select <b>Auto</b> to set it automatically.</li> <li>• <b>Channel:</b> Select the channel to use for the b/g/n (2.4GHz) radio, or select <b>Auto</b> to set it automatically.</li> <li>• <b>TX Power Adjustment:</b> Select the preferred TX power, if you want to manually configure the transmit power on the 2.4GHz radio. By default, TX power is set to <b>Full</b> on the 2.4GHz radio</li> </ul>

Option	Description
<b>Radio Options a/n/c (5GHz)</b>	<p>Configure the following options:</p> <ul style="list-style-type: none"> <li>• <b>Channelization:</b> Set the channel width used during transmission to either <b>20</b>, <b>40</b>, or <b>80</b> (MHz), or select <b>Auto</b> to set it automatically.</li> <li>• <b>Channel (Indoor):</b> Select the indoor channel to use for the <b>a/n/c</b> (5GHz) radio, or select <b>Auto</b> to set it automatically.</li> <li>• <b>Channel (Outdoor):</b> Select the outdoor channel to use for the <b>a/n/c</b> (5GHz) radio, or select <b>Auto</b> to set it automatically.</li> <li>• <b>TX Power Adjustment:</b> Select the preferred TX power, if you want to manually configure the transmit power on the 5GHz radio. By default, TX power is set to <b>Full</b> on the 5GHz radio.</li> </ul>

6. Configure AP GRE Tunnel Options.

- **Tunnel Type:** Select a protocol to use for tunneling WLAN traffic back to the controller. Options include **RuckusGRE**, **SoftGRE**, and **SoftGRE+IPSec**.

**NOTE:** AP zones configured with IPv6 network address configuration only support RuckusGRE tunnel type.

- **Tunnel Profile:** Select the tunnel profile that you want to use. If you want to use Ruckus GRE tunneling for this AP zone, you can use the default tunnel profile or you can select a profile that you created. If you want to use SoftGRE tunneling, you must first create a SoftGRE tunnel profile.

SoftGRE tunnel type support IPv4 SoftGER and IPv6 SoftGRE tunnel profiles, and SoftGRE+IPSec tunnel type support IPv4 SoftGRE and IPv6 IPSec tunnel profiles.

**NOTE:** For more information on creating Ruckus GRE and SoftGRE tunnel profiles, see [Creating AP Tunnel Profiles](#).

**Table 4: Tunnel Types**

Tunnel Type	Unencrypted	Encrypted with IPsec
Ruckus GRE over IPv4	Supported	Supported
Ruckus GRE over IPv6	Supported*	Supported*
SoftGRE over IPv4	Supported	Supported
SoftGRE over IPv6	Supported**	Supported*

**NOTE:** \* indicates that tunneling over IPv6 is supported only in AP zones supporting IPv6. Dual-stack zones will not tunnel with IPv6.

**NOTE:** \*\* indicates that SoftGRE tunneling over IPv6 is supported in AP zones with IPv6 and dual-stack AP zones.

7. Configure Syslog Options.

- To send events related to APs in this zone to an external syslog server, select the Enable external syslog server for APs in this zone check box. Additional options appear below.
- **Server Address:** Type the IP address of the syslog server on the network.

**NOTE:** The IP address format that you enter here will depend on the AP IP mode that you selected earlier in this procedure. If you selected **IPv4 Only**, enter an IPv4 address. If you selected **IPv6 Only**, enter an IPv6 address.

- **Port:** Type the syslog port number on the server.
- **Facility:** Select the facility level that will be used by the syslog message. Options include Local0 (default), Local1, Local2, Local3, Local4, Local5, Local6, and Local7.
- **Priority:** Select the lowest priority level for which events will be sent to the syslog server. For example, to only receive syslog messages for events with the warning (and higher) priority, select **Warning**. To receive syslog messages for all events, select **All**.

8. Configure the **AP SNMP Options:** select the **Enable AP SNMP** check-box to configure the SNMPv2 and SNMPv3 settings.

9. Configure Advanced Options.

**Option**

**Description**

**Channel Mode**

If you want to allow outdoor APs that belong to this zone to use wireless channels that are regulated as indoor-use only, select the **Allow indoor channels** check box. For more information, see [Channel Mode](#) on page 76.

**Auto Channel Selection**

You can adjust the AP channel to 2.4 GHz or 5 GHz frequencies by selecting the appropriate check-box.

Further, you can automatically adjust the AP to optimize performance by choosing one of the following:

- **Background Scanning :** Changes the AP channel if there is interference.
- **ChannelFly:** Continuously monitors potential throughput and changes the AP channel to minimize interference and optimize throughput.

**Background Scanning**

If you want APs to evaluate radio channel usage automatically, enable and configure the background scanning settings on both the 2.4GHz and 5GHz radios. By default, background scanning is enabled on both radios and is configured to run every 20 seconds.

Option	Description
<b>Smart Monitor</b>	<p>To disable the WLANs of an AP (that belongs to this zone) whenever the AP uplink or Internet connection becomes unavailable, select the <b>Enable</b> check box. And then, configure the following options:</p> <ul style="list-style-type: none"><li>• <b>Health Check Interval:</b> Set the interval (between 5 and 60 seconds) at which the AP will check its uplink connection. The default value is 10 seconds.</li><li>• <b>Health Check Retry Threshold:</b> Set the number of times (between 1 and 10 times) that the AP will check its uplink connection. If the AP is unable to detect the uplink after the configured number of retries, the AP will disable its WLANs. The default value is 3 retries.</li></ul> <p><b>NOTE:</b> When the AP disables its WLANs, the AP creates a log for the event. When the AP's uplink is restored, it sends the event log (which contains the timestamp when the WLANs were disabled, and then enabled) to the controller.</p>
<b>VLAN Pooling</b>	<p>This option allows you to overlap VLANs within VLAN pooling profiles. For example, if a VLAN profile by name vlan-pooling-1 uses VLAN IDs 100 to 105, and another profile vlan-pooling-2 uses VLAN IDs 102 to 107, the overlapping VLAN IDs are 102 to 105.</p> <p>For more information, see <a href="#">About VLAN Pooling</a>.</p>
<b>AP Management VLAN</b>	<p>To override the management VLAN tag that has been configured on the AP, click <b>VLAN ID</b>, and then type the VLAN ID that you want to assign (valid range is from 1 to 4094). To keep the same management VLAN ID that has been configured on the AP, click <b>Keep AP's settings</b>.</p>
<b>Rogue AP Detection</b>	<p>Select the <b>Report rogue access points</b> check box to enable rogue device detection in logs and email alarm event notifications.</p> <ul style="list-style-type: none"><li>• <b>Report all rogue devices:</b> Send alerts for all rogue AP events.</li></ul>

Option	Description
	<ul style="list-style-type: none"><li>• <b>Report only malicious rogue devices of type:</b> Select which event types to report. Events include SSID spoofing, same network, and MAC spoofing.</li><li>• <b>Protect the network from malicious rogue access points:</b> Select this check box to automatically protect your network from network connected rogue APs, SSID-spoofing APs and MAC-spoofing APs. When one of these rogue APs is detected (and this check box is enabled), the Ruckus Wireless AP automatically begins sending broadcast de-authentication messages spoofing the rogue's BSSID (MAC) to prevent wireless clients from connecting to the malicious rogue AP. This option is disabled by default.</li></ul>
<b>Client Load Balancing</b>	Improve WLAN performance by enabling load balancing. Load balancing spreads the wireless client load between nearby access points, so that one AP does not get overloaded while another sites idle. Load balancing must be enabled on a per-radio basis. To enable load balancing, select the <b>Enable loading balancing on [2.4GHz or 5GHz]</b> check box, and then set or accept the default Adjacent Radio Threshold (50dB for the 2.4GHz radio and 43dB for the 5GHz radio).
<b>Band Balancing</b>	Client band balancing between the 2.4GHz and 5GHz radio bands is disabled by default on all WLANs. To enable band balancing for this WLAN, select the Enable band balancing on radios by distributing the clients on 2.4GHz and 5GHz bands check box, and then set the percentages of client load that will be distributed between the 2.4GHz and 5Ghz bands. For more information, see <a href="#">Band Balancing</a> on page 77.
<b>Location Based Service</b>	To enable LBS service for this AP zone, select the Enable LBS Service check box, and then select an LBS server to use from the drop-down list. For information on how to add

Option	Description
	an LBS server to the controller, see <a href="#">Configuring Location Services</a> on page 167.
<b>Client Admission Control</b>	Set the load thresholds on the AP at which it will stop accepting new clients. See <a href="#">Configuring Client Admission Control</a> .
<b>AP Reboot Timeout</b>	Set the time after which the AP will reboot automatically when it is unable to reach the default gateway or the control interface. <ul style="list-style-type: none"><li>• <b>Reboot AP if it cannot reach default gateway after [ ] minutes:</b> The default timeout is 30 minutes.</li><li>• <b>Reboot AP if it cannot reach the controller after [ ]:</b> The default timeout is 2 hours.</li></ul>

10. Click **OK** to finish creating your first AP zone.

When the controller completes creating the AP zone, the following confirmation message appears: AP zone created successfully. Do you want to view the configuration details?

11. Click **Yes** to view the AP zone details, or click **No** to close the confirmation message and return to the AP zone list.

You have completed creating an AP zone. You can create additional AP zones as needed.

Figure 11: The Create New AP Zone form

### ChannelFly and Background Scanning

SmartZone controllers offer the ChannelFly and Background Scanning automatic channel selection methods for spectrum utilization and performance optimization. While Background Scanning must be enabled for rogue AP detection, AP location detection and radio power adjustment, either can be used for automatic channel optimization.

The main difference between ChannelFly and Background Scanning is that ChannelFly determines the optimal channel based on real-time statistical analysis of actual throughput measurements, while Background Scanning uses channel measurement and other techniques to estimate the impact of interference on Wi-Fi capacity based on progressive scans of all available channels.

**NOTE:** If you enable ChannelFly, Background Scanning can still be used for adjusting radio power and rogue detection while ChannelFly manages the channel assignment. Both cannot be used at the same time for channel management.

#### Benefits of ChannelFly

With ChannelFly, the AP intelligently samples different channels while using them for service. ChannelFly assesses channel capacity every 15 seconds and changes channel when, based on historical data, a different channel is likely to offer higher capacity than the current channel. Each AP makes channel decisions based on this historical data and maintains an internal log of channel performance individually.

When ChannelFly changes channels, it utilizes 802.11h channel change announcements to seamlessly change channels with no packet loss and minimal impact to performance. The 802.11h channel change announcements affect both wireless clients and Ruckus mesh nodes in the 2.4 GHz and/or 5 GHz bands.



Initially (in the first 30-60 minutes) there will be more frequent channel changes as ChannelFly learns the environment. However, once an AP has learned about the environment and which channels are most likely to offer the best throughput potential, channel changes will occur less frequently unless a large measured drop in throughput occurs.

ChannelFly can react to large measured drops in throughput capacity in as little as 15 seconds, while smaller drops in capacity may take longer to react to.

#### Disadvantages of ChannelFly

Compared to Background Scanning, ChannelFly takes considerably longer for the network to settle down. If you will be adding and removing APs to your network frequently, Background Scanning may be preferable. Additionally, if you have clients that do not support the 802.11h standard, ChannelFly may cause significant connectivity issues during the initial capacity assessment stage.

You can enable/disable ChannelFly per band. If you have 2.4 GHz clients that do not support 802.11h, Ruckus recommends disabling ChannelFly for 2.4 GHz but leaving it enabled for the 5 GHz band.

#### Background Scanning

Using Background Scanning, SmartZone controllers regularly samples the activity in all Access Points to assess RF usage, to detect rogue APs and to determine which APs are near each other for mesh optimization. These scans sample one channel at a time in each AP so as not to interfere with network use. This information is then applied in AP Monitoring and other controller monitoring features. You can, if you prefer, customize the automatic scanning of RF activity, deactivate it if you feel it's not helpful, or adjust the frequency, if you want scans at greater or fewer intervals.

**NOTE:** Background Scanning must be enabled for SmartZone controllers to detect rogue APs on the network.

#### VLAN Pooling

When Wi-Fi is deployed in a high density environment (such as a stadium) or on a university campus to provide access for students, the number of IP addresses required for client devices can easily run into several thousands.

Allocating a single large subnet results in a high probability of degraded performance due to factors like broadcast/multicast traffic.

To address this problem, VLAN pooling provides a method by which administrators can deploy pools of multiple VLANs from which clients are assigned, thereby automatically segmenting large groups of clients into smaller subgroups, even when connected to the same SSID.

As the client device joins the Wi-Fi network, the VLAN is assigned based on a hash of the client's MAC address (by default).

## Cloning an AP Zone from the Domain Tree

Cloning an AP zone enables you to copy the configuration of an existing zone and save it as a new zone.

If you need to create an AP zone with configuration settings that are similar to an existing AP zone, cloning that existing AP zone would be the easiest way to do it.

Follow these steps to clone an AP zone.

1. Go to **Configuration > AP Zones**.
2. In the domain tree, find the AP zone that you want to clone.
3. Click **Clone**.

A form appears and prompts you for the name that you want to assign to the cloned zone. The default name is Clone of {Original Zone Name}.

4. Edit the AP zone name or leave it as is.
5. Click **OK** to finish cloning the AP zone.

### AP Zone: Zone1 >> Zone Configuration

View the common configuration settings in the selected zone, including general zone level settings and AP model-specific settings.			
General Information		Radio & Tunnel Information	
Zone Name	Zone1	Background Scan (2.4 GHz/5 GHz)	20 Seconds / 20 Seconds
Description	Zone1	Channelization (2.4 GHz/5 GHz)	20MHz / 40MHz
Created By	admin	Channel (2.4 GHz/5 GHz)	8 / 58(indoor), 161(outdoor)
Updated On	2015/09/07 15:16:41	TX Power Adjustment (2.4 GHz/5 GHz)	Full/Auto / Full/Auto
AP Firmware	3.2.0.0.548	Tunnel Type	Ruckus GRE (GRE+UDP)
Mesh	Disabled	GRE Tunnel Profile	Default Tunnel Profile
Country Code	India		
Switchover Cluster	Disabled		
Time Zone	(GMT+0:00) UTC		
AP IP Mode	IPv4		

Figure 12: Click the Clone button to save the AP zone as a new zone

## Cloning an AP Zone from the AP Zone List

Another method to save an existing AP zone as a new zone is by cloning it from the **AP Zone List** page.

Follow these steps to clone an AP zone from the **AP Zone List** page.

1. Go to **Configuration > AP Zones**.
2. On the **AP Zones List** page, find the AP zone that you want to clone.
3. Click the action icon that is in the same row as the AP zone name.
4. A form appears and prompts you for the name that you want to assign to the cloned zone. The default name is Clone\_of\_{Original Zone Name}.
5. Edit the AP zone name or leave it as is.
6. Click **Apply**.

The page refreshes, and then the AP zone that you cloned appears in the **AP Zone List**. You have completed cloning an AP zone from the AP zone list. need graphic A form prompts you for the name that you want to assign to the cloned zone

### Viewing Existing AP Zones

Follow these steps to view a list of existing AP zones.

1. Go to Configuration > AP Zones.

The **AP Zone List** page appears and displays a list of existing AP zones.

2. To view the configuration of a specific zone, locate the zone whose details you want to view on the **AP Zone List** page.
3. Under the **Zone Name** column, click the AP zone name.

The page refreshes and displays the AP zone configuration page.

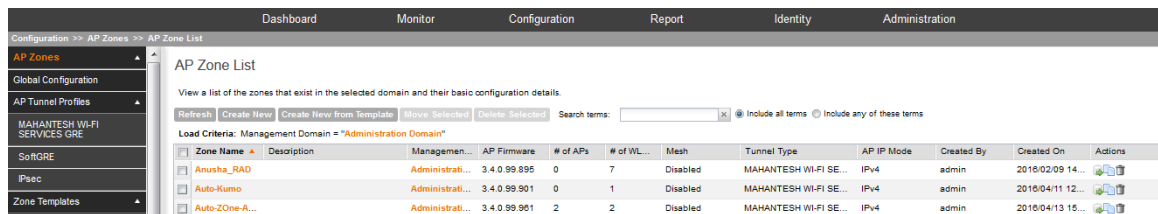


Figure 13: The AP Zone List page

### Viewing the AP Zone Configuration

Follow these steps to view a summary of the AP zone configuration.

1. Go to Configuration > AP Zones.
2. On the **AP Zone List** page, click the name of the AP zone that you want to view.

The **Zone Configuration** page for the AP zone appears and displays as summary of the AP zone configuration.

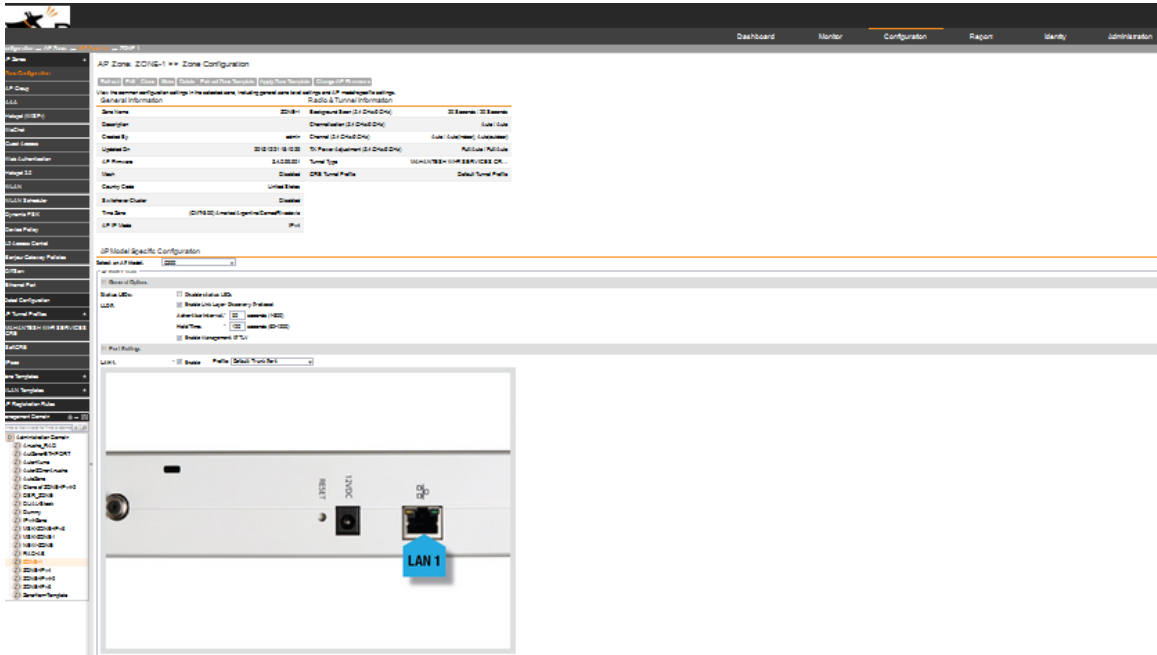


Figure 14: The Zone Configuration page displays a summary of the zone settings

The following buttons and options also appear on the page:

- **Edit:** Click to edit the AP zone configuration.
- **Clone:** Click to clone this AP zone.
- **Move:** Click to move this AP zone from its current management domain to another.
- **Delete:** Click to delete this AP zone.

If you want to override the AP zone settings for specific AP models, configure the AP Model-Specific Configuration section at the bottom of the page (see [Modifying Model Specific Controls](#) for more information).

### Deleting an AP Zone

Deleting an AP zone that contains managed devices will automatically move those devices to the Staging Zone (default zone).

Before deleting an AP zone, Ruckus Wireless recommends moving devices that belong to that zone to another zone.

Follow these steps to delete an AP zone.

1. Go to **Configuration > AP Zones**.
2. In the domain tree, select the AP zone that you want to delete.
3. Click the **Delete Selected** button.  
A confirmation message appears.
4. Click **OK**.

You have completed deleting an AP zone.

## Working with AP Groups

AP (access point) groups can be used to define configuration options and apply them to groups of APs at once, without having to individually modify each AP's settings.

For each group, administrators can create a configuration profile that defines the channels, radio settings, Ethernet ports and other configurable fields for all members of the group or for all APs of a specific model in the group. AP groups are similar to WLAN groups (see [Working with WLAN Groups](#) for more information). While WLAN groups can be used to specify which WLAN services are served by which APs, AP groups are used for more specific fine-tuning of how the APs themselves behave.

**NOTE:** AP group configuration settings can be overridden by individual AP settings. For example, if you want to set the transmit power to a lower setting for only a few specific APs, leave the Tx Power Adjustment at **Auto** in the AP group configuration page, then go to the individual AP configuration page (**Configuration > Access Points > Edit [AP MAC address]**) and set the **Tx Power Setting** to a lower setting.

### Creating an AP Group

Creating an AP group means creating a configuration profile that defines the channels, radio settings, Ethernet ports and other configurable fields for all members of the group or for all APs of a specific model in the group.

Follow these steps to create an AP group.

1. Go to **Configuration > AP Zones**.
2. On the **AP Zone List** page, click the AP zone name within which you want to create the AP group.

The page refreshes, and the **AP Zone** submenu appears on the sidebar.

3. On the sidebar, click **AP Groups**.
4. Click **Create New**.

The **Create New AP Groups** form appears.

5. In **General Settings**, configure the following:

- **Name:** Type a name for this AP group.
- **Description:** Type a description for this AP group.
- **Location:** Type a location name (for example, Ruckus Wireless HQ) for this AP group.
- **Location Additional Information:** Type additional location information for the AP group, if any (for example, 350 W Java Dr, Sunnyvale, CA 94089, United States).

You can select the **Override zone configuration** check-box if you want to cancel the AP zone configuration that was set previously.

- **GPS Coordinates:** Type the longitude, altitude, and latitude coordinates for the AP group's location.

6. In **Group Members**, configure the following:

- **Members:** When you are creating a new AP group, this section will be empty. This will be populated after you select the access points that you want to belong to this AP group.
- **Access Points:** This section shows all the access points that currently belong to the AP zone. Select the check boxes before the **Member** column (which shows the AP MAC addresses) of each AP that you want to add to the AP group, and then click Add to Group. The APs you selected appear under the **Members** section.

7. In **Radio Options**, if you want to override a setting that has been defined for this zone, select the **Override zone configuration** check box for that setting, and then configure that setting (see the table below for more information about each setting). If you want to preserve the original configuration of the zone, skip this step.

Option	Description
<b>Channel Range (2.4G)</b>	If you want to override the 2.4GHz channel range that has been configured for the zone to which this AP group belong, select the check boxes for the channels on which you want the 2.4GHz radios of managed APs to operate. Channel options include channels 1 to 11. By default, all channels are selected.
<b>DFS Channels</b>	<p>If the country code that is selected in the <b>General Options</b> section of this page is <b>United States</b>, the <b>Allow DFS channels</b> check boxes appears. Selecting this check box adds Dynamic Frequency Selection (DFS) channels to the list of 5GHz channels (see below) that managed APs can use indoors and outdoors.</p> <p>DFS channels, which are special channels allocated for radar signals, can be used by unlicensed devices (such as APs and wireless clients) if no radar signals are using them. If radar signals are detected on a DFS channel that is currently used by devices, those devices will automatically vacate the channel and use an alternate channel.</p>
<b>Channel Range (5G) Indoor</b>	Select the check boxes for the channels on which you want the 5GHz radios of managed <i>indoor</i> APs to operate. If you selected the <b>Allow DFS channels</b> check box above, the list of channel options includes the DFS channels.
<b>Channel Range (5G) Outdoor</b>	Select the check boxes for the channels on which you want the 5GHz radios of managed <i>outdoor</i> APs to operate. If you selected the <b>Allow DFS channels</b> check box above, the list of channel options includes the DFS channels.
<b>Radio Options b/g/n (2.4 GHz)</b>	<p>Configure the following options:</p> <ul style="list-style-type: none"> <li>• <b>Channelization:</b> Set the channel width used during transmission to either <b>20</b> or <b>40</b> (MHz), or select <b>Auto</b> to set it automatically.</li> <li>• <b>Channel:</b> Select the channel to use for the b/g/n (2.4GHz) radio, or select <b>Auto</b> to set it automatically.</li> <li>• <b>TX Power Adjustment:</b> Select the preferred TX power, if you want to manually configure the transmit power on the 2.4GHz radio. By default, TX power is set to <b>Full</b> on the 2.4GHz radio</li> <li>• <b>WLAN Group:</b> Specify to which WLAN group this AP group belongs.</li> </ul>

Option	Description
<b>Radio Options a/n/c (5GHz)</b>	Configure the following options: <ul style="list-style-type: none"><li>• <b>Channelization:</b> Set the channel width used during transmission to either <b>20</b>, <b>40</b>, or <b>80</b> (MHz), or select <b>Auto</b> to set it automatically.</li><li>• <b>Channel (Indoor):</b> Select the indoor channel to use for the <b>a/n/c</b> (5GHz) radio, or select <b>Auto</b> to set it automatically.</li><li>• <b>Channel (Outdoor):</b> Select the outdoor channel to use for the <b>a/n/c</b> (5GHz) radio, or select <b>Auto</b> to set it automatically.</li><li>• <b>TX Power Adjustment:</b> Select the preferred TX power, if you want to manually configure the transmit power on the 5GHz radio. By default, TX power is set to <b>Full</b> on the 5GHz radio.</li><li>• <b>WLAN Group:</b> Specify to which WLAN group this AP group belongs.</li></ul>

8. In **AP SNMP Options**, select the **Override zone configuration** check-box to replace the AP zone configuration, and select the **Enable AP SNMP** check-box to configure the SNMP settings.

9. In **Model Specific Options**, configure LED, LLDP, and port settings of all APs of each specific model that are members of the AP group.

See [Modifying Model Specific Controls](#).

10. In **Advanced Options**, select the **Override zone config** check boxes for the settings that you want to override, and then configure them.

- **Location Based Service:** To disable the LBS service for this AP group, clear the Enable LBS service check box. To use a different LBS server for this AP group, select the Enable LBS service check box, and then select the LBS server that you want to use from the drop-down list.
- **Hotspot 2.0 Venue Profile:** If you have configured Hotspot 2.0 venue profiles, select the profile that you want to assign to this AP group.
- **AP Management VLAN:** To override the management VLAN tag that has been configured on the AP, click **VLAN ID**, and then type the VLAN ID that you want to assign (valid range is from 1 to 4094). To keep the same management VLAN ID that has been configured on the AP, click **Keep AP's settings**
- **Client Admission Control:** Set the load thresholds on the AP at which it will stop accepting new clients. See [Configuring Client Admission Control](#).

11. Click **OK**.

You have completed creating an AP group.

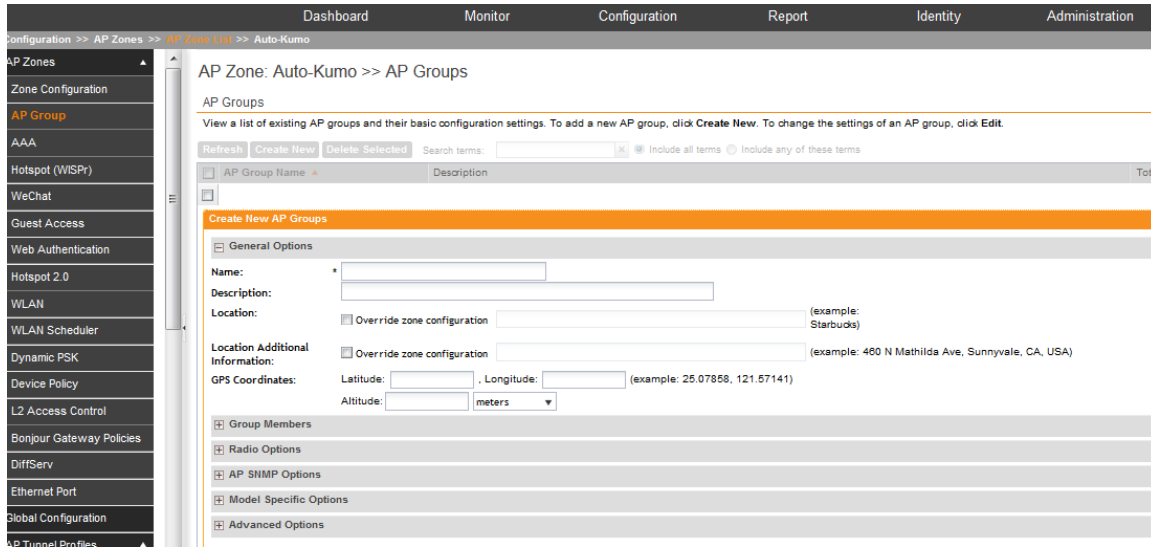


Figure 15: The Create New AP Group form

### Configuring Model Based Settings

If you want to apply a set of settings to all APs of a particular model, use the **Model Based Settings** page.

Follow the steps to configure the model based settings.

1. On the menu, click **Configuration > Access Points**.  
The **AP List** page appears.
2. Click the MAC address of the AP for which you want to configure the model based settings.  
The **Edit AP Configuration** form appears.
3. Scroll down to **Model Specific Options** section, and then click the + icon to expand the section.
4. In **Model Specific Control**, select the **Override zone configuration** check box.  
The settings available for the AP model appear.
5. **NOTE:** The options that appear in the **General Options** section depend on the AP model that you select. Not all the options described in the table below will appear for every AP model.

In the **General Options** section, configure the following settings:

Option	Description
<b>PoE out port</b>	To enable the PoE out port on the selected AP model, select the <b>Enable PoE out ports (specific ZoneFlex AP models only)</b> .

**NOTE:** If the controller country code is set to United Kingdom, an additional **Enable 5.8 GHz Channels** option will be available for outdoor 11n/11ac APs. Enabling this option allows the use of restricted C-band channels. These channels are disabled by default and should only be enabled by customers with a valid license to operate on these restricted channels.



Option	Description
<b>PoE Operating Mode</b>	Select the PoE operating mode of the selected AP model. Available options include Auto (default), 802.3af and 802.3at mode. If 802.3af PoE is selected, this AP model will operate in 802.3af mode and will consume less power than in 802.3at mode. However, when this option is selected, some AP features are disabled to reduce power consumption, such as the USB port and one of the Ethernet ports. See the <i>Access Point User Guide</i> for model-specific information.
<b>Internal Heater</b>	To enable the heater that is built into the selected AP model, select the <b>Enable internal heaters (specific AP models only)</b> check box.
<b>Status LEDs</b>	To disable the status LED on the selected AP model, select the <b>Disable Status LEDs</b> check box.
<b>LLDP</b>	To enable the Link Layer Discovery Protocol (LLDP) on the selected AP model, select the <b>Enable Link Layer Discovery Protocol</b> check box.
<b>External Antenna (2.4 GHz)</b>	To enable the external 2.4 GHz antenna on the selected AP model, select the <b>Enable external antenna</b> check box, and then set the gain value (between 0 and 90dBi) in the box provided.
<b>External Antenna (5 GHz)</b>	To enable the external 5 GHz antenna on the selected AP model, select the <b>Enable external antenna</b> check box, and then set the gain value (between 0 and 90dBi) in the box provided.
<b>USB Port</b>	To disable the USB port on the selected AP model, select the <b>Disable USB port</b> check box. USB ports are enabled by default.

6. **NOTE:** The number of LAN ports that appear in this section correspond to the physical LAN ports that exist on the selected AP model.

**NOTE:** When trunk port limitation is enabled, the controller does not validate the port settings configured in the AP or the AP group with no members.

In the **Port Settings** section, configure the following options for each LAN port.

Option	Description
<b>Enable check box</b>	Use this option to enable and disable this LAN port on the selected AP model. By default, this check box is selected. To disable this LAN port, clear this check box.
<b>Profile</b>	Use this option to select the Ethernet port profile that you want this LAN port to use. Two default Ethernet port profile exist: <b>Default Trunk Port</b> (selected by default) and <b>Default Access Port</b> . If you created Ethernet port profiles (see <a href="#">Creating an Ethernet Port Profile</a> on page 93), these profiles will also appear on the drop-down list.

**NOTE:** If you recently created an Ethernet port profile and it does not appear on the drop-down menu, click **Reload** on the drop-down menu to refresh the Ethernet port profile list.

7. Click **Apply**.

The message `Please wait...` appears. When the message disappears, you have completed configuring the settings of the selected AP model.

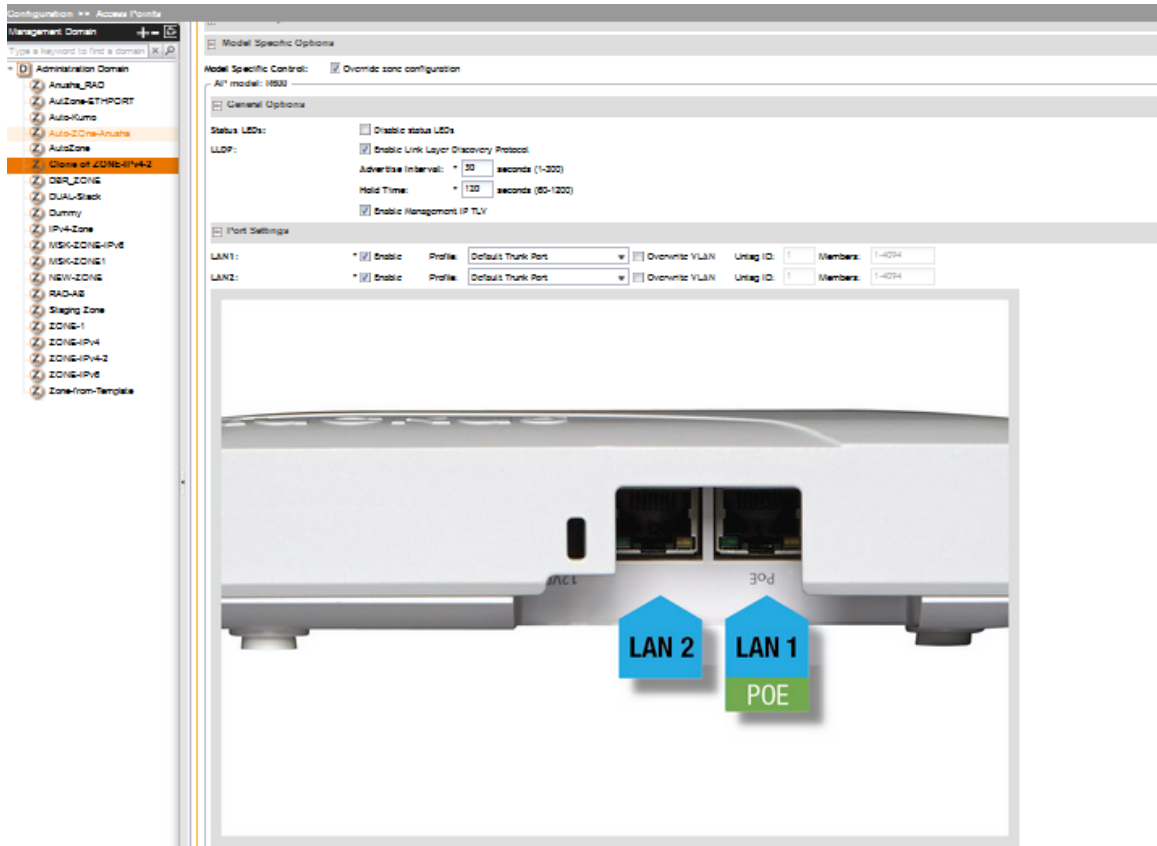


Figure 16: Options for configuring AP model specific settings

**Supported LLDP Attributes**

The Link Layer Discovery Protocol (LLDP) is a vendor-neutral Layer 2 protocol that allows a network device (for example, a Ruckus Wireless AP) to advertise its identity and capabilities on the local network.

LLDP information is sent by devices from each of their interfaces at a fixed interval (default is 30 seconds), in the form of an Ethernet frame. Each LLDP Ethernet frame contains a sequence of type-length-value (TLV) structures starting with Chassis ID, Port ID and Time to Live (TTL) TLV. [Table 2](#) lists the LLDP attributes supported by the controller.

**Table 5: LLDP attributes supported by the controller**

Attribute (TLV)	Description
Chassis ID	Indicates the MAC address of the AP's br0 interface
Port ID	Identifies the port from which the LLDP packet was sent
Time to Live	Same as LLDP Hold Time. Indicates the length of time (in seconds) that a receiving device will hold the LLDP information

Attribute (TLV)	Description
	sent by the selected AP model before discarding it. The default value is 120 seconds.
System Name	Indicates the name assigned to the AP. The default name of Ruckus Wireless APs is RuckusAP.
System Description	Indicates the AP model plus software version
System Capabilities	Indicates the AP's capabilities (Bridge, WLAN AP, Router, Docsis), and which capabilities are enabled
Management Address	Indicates the management IP address of the AP
Port Description	Indicates the description of the port in alphanumeric format

### Configuring the Port Settings of a Particular AP Model

Use Port Settings in the **AP Model-Specific Configuration** section to configure the Ethernet ports of a particular AP model.

Follow these steps to configure the port settings of a certain AP model.

1. All ports are enabled by default (the Enable check boxes are all selected). To disable a particular port entirely, clear the Enable check box next to the port name (LAN1, LAN2, etc.)
2. For any enabled ports, you can choose whether the port will be used as a Trunk Port, Access Port, or General Port.

The following restrictions apply:

- All APs must be configured with at least one Trunk Port.

**NOTE:** You cannot move an AP model to an AP group and configure the AP model to use a trunk port at the same time, if general ports are enabled when trunk port limitation is disabled. You must configure the selected AP model to use at least one trunk port, and then move the AP model to the AP group.

- For single port APs, the single LAN port must be a trunk port and is therefore not configurable.
- For ZoneFlex 7025/7055, the LAN5/Uplink port on the rear of the AP is defined as a Trunk Port and is not configurable. The four front-facing LAN ports are configurable.
- For all other APs, you can configure each port individually as either a Trunk Port, Access Port, or General Port. See [Designating an Ethernet Port Type](#) on page 52 for more information.

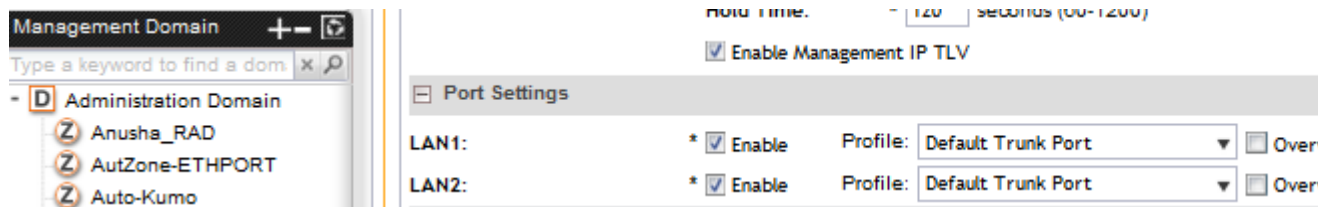


Figure 17: The Port Settings section

## Designating an Ethernet Port Type

Ethernet ports can be configured as access ports, trunk ports, or general ports.

Trunk links are required to pass VLAN information between switches. Access ports provide access to the network and can be configured as members of specific VLANs, thereby separating the traffic on these ports from traffic on other VLANs. General ports are user-defined ports that can have any combination of up to 20 VLAN IDs assigned.

For most ZoneFlex APs, you can set which ports you want to be your Access, Trunk and General Ports from the controller web interface, as long as at least one port on each AP is designated as a Trunk Port.

By default, all ports are enabled as Trunk Ports with Untag VLAN set as 1 (except for ZoneFlex 7025, whose front ports are enabled as Access Ports by default). If configured as an Access Port, all untagged ingress traffic is the configured Untag VLAN, and all egress traffic is untagged. If configured as a Trunk Port, all untagged ingress traffic is the configured Untag VLAN (by default, 1), and all VLAN-tagged traffic on VLANs 1-4094 will be seen when present on the network.

The default Untag VLAN for each port is VLAN 1. Change the Untag VLAN to:

- Segment all ingress traffic on this Access Port to a specific VLAN.
- Redefine the native VLAN on this Trunk Port to match your network configuration.

When trunk port limitation is disabled using the `eth-port-validate-one-trunk disable` command, validation checks are not performed for the VLAN members and the AP Management VLAN. If the AP configuration for general ports and access ports does not include a member of an AP management VLAN, or the VLAN of a WAN interface configured through CLI, the AP will disconnect and the Ethernet port stops transmitting data. Make sure that you configure the correct VLAN member in the ports (general/access) and the AP management VLAN.

**NOTE:** Ensure that at least one of the general port VLANs is the same as a Management VLAN of the AP.

## Access Ports

Access ports provide access to the network and can be configured as members of a specific VLAN, thereby separating the traffic on these ports from traffic on other VLANs.

All Access Ports are set to Untag (native) VLAN 1 by default. This means that all Access Ports belong to the native VLAN and are all part of a single broadcast domain. When untagged frames from a client arrive at an AP's Access Port, they are given an 802.1Q VLAN header with 1 as their VLAN ID before being passed onto the wired network.

When VLAN 1 traffic arrives destined for the client, the VLAN tag is removed and it is sent as plain (untagged) 802.11 traffic. When any tagged traffic other than VLAN 1 traffic arrives at the same Access Port, it is dropped rather than forwarded to the client.

To remove ports from the native VLAN and assign them to specific VLANs, select Access Port and enter any valid VLAN ID in the VLAN ID field (valid VLAN IDs are 2-4094).

The following table describes the behavior of incoming and outgoing traffic for Access Ports with VLANs configured.

**Table 6: Access Ports with VLANs configured**

VLAN Settings	Incoming Traffic (from Client)	Outgoing Traffic (to Client)
Access Port, Untag VLAN 1	All incoming traffic is native VLAN (VLAN 1).	All outgoing traffic on the port is sent untagged.
Access Port, Untag VLAN [2-4094]	All incoming traffic is sent to the VLANs specified.	Only traffic belonging to the specified VLAN is forwarded. All other VLAN traffic is dropped.

**Trunk Ports**

Trunk links are required to pass VLAN information between switches. Trunking is a function that must be enabled on both sides of a link.

If two switches are connected together, for example, both switch ports must be configured as trunk ports.

The trunk port is a member of all the VLANs that exist on the AP/switch and carries traffic for all VLANs between switches.

For a trunk port, the VLAN Untag ID field is used to define the native VLAN - the VLAN into which untagged ingress packets are placed upon arrival. If your network uses a different VLAN as the native VLAN, configure the AP trunk port's VLAN Untag ID with the native VLAN used throughout your network.

**General Ports**

General ports are user-specified ports that can have any combination of up to 20 VLAN IDs assigned.

General ports function similarly to Trunk ports, except that where Trunk ports pass all VLAN traffic, General ports pass only the VLAN traffic that is defined by the user.

To configure an AP Ethernet port as a General port, select General Port and enter multiple valid VLAN IDs separated by commas or a range separated by a hyphen.

**NOTE:** You must also include the Untag VLAN ID in the Members field when defining the VLANs that a General port will pass. For example, if you enter 1 as the Untag VLAN ID and want the port to pass traffic on VLANs 200 and 300, you would enter: 1,200,300.

**Configuring Client Admission Control**

As an administrator, you can help maintain a positive user experience for wireless users on the network by configuring the following client admission control settings:

- Minimum client count
- Maximum radio load
- Minimum client throughput

Client admission control is implemented on a per radio basis and is currently only supported on 802.11n APs.

### Configuring AP SNMP Options

Use the AP SNMP Options in the AP Groups section to configure the SNMP settings of a particular AP.

1. Go to **Configuration > AP Zones > AP Zone List > AP Group**.  
The **AP Groups** page appears.
2. Click **Create New**.  
The **Create New AP Group** form is displayed.
3. In **AP SNMP Options**, configure the following:
  - **Override zone configuration**: select the check-box to override the existing configuration for the AP zone.
  - **Enable AP SNMP**: select the check-box to modify the SNMPv2 and SNMPv3 settings.
4. Click **OK**.

**NOTE:**

AP SNMP Options can be configured at the AP, zone, zone template, AP group, and AP group template levels.

**NOTE:** The Inform function is not supported for SNMP v3 agents.

AP SNMP Options

Override zone configuration

Enable AP SNMP

SNMPv2 Agent

Community	Privilege
-----------	-----------

Add Community

SNMPv3 Agent

User	Authentication	Auth Pass Phrase	Privacy	Privacy Phrase	Privilege
------	----------------	------------------	---------	----------------	-----------

**Figure 18: Configuring AP SNMP options for AP Groups**

The following limitations apply to AP SNMP configurations:

- SNMP v2 and SNMP v3 configurations only allow one notification target.
- You can only set **Community max count** and **Users max count** values up to 3.
- The **Read**, **Write** and **Notification** privileges for communities and users must be different.

## Working with AAA Servers

You can configure the controller to use external AAA servers to authenticate users.

### Creating an AAA Server

To add and manage AAA servers that the controller can use to authenticate users.

Follow these steps to create a RADIUS or RADIUS Accounting server (if you have one on the network) for the AP zone.

1. Click Configuration > AP Zones > Zone Name ({AP Zone Name}) > AAA.

For example, if you want to create an AAA server for an AP zone named `ap-zone-1`, click Configuration > AP Zones > Zone Name (`ap-zone-1`) > AAA.

2. Click **Create** New.

The form for creating a new zone RADIUS server appears.

3. Configure **General Options**.

- Name: Type a name for the AAA server that you are adding.
- Description: Type a brief description for the AAA server.
- Type: Select the type of AAA server that you have on the network. Options include:
  - RADIUS
  - RADIUS Accounting
  - Active Directory
  - LDAP

**NOTE:** AP zones with dual network configuration only support AAA server configuration with IPv4 addresses.

4. In the **Primary Server** section, configure the settings of the primary RADIUS server, RADIUS Accounting server, Active Directory and LDAP.

- IP Address: Type the IP address of the AAA server.

**NOTE:** The format of the IP address that you need to enter here depends on the AP IP mode that you selected when you created the AP zone (see [Creating an AP Zone](#)). If you selected **IPv4 Only**, enter an IPv4 address. If you selected **IPv6 Only**, enter an IPv6 address. Ensure that the IP address of the AAA server is the same in the primary server and the secondary server.

- Port: Type the port number of the AAA server. The default RADIUS server port number is 1812 and the default RADIUS Accounting server port number is 1813.
- Shared Secret: Type the AAA shared secret.
- Confirm Secret: Retype the shared secret to confirm.

- Windows Domain name: Type the domain name for the Windows server
- Admin Domain Name: Type the domain name for the administrator.
- Admin Password: Type the administrator password.
- Confirm Password: Re-type the password to confirm.
- Base Domain Name: Type the name of the base domain.
- Key Attribute: Type the key attribute such as UID.
- Search Filter: Type filter by which you want to search such as *objectClass=\**

5. In the **Secondary Server** section, configure the settings of the secondary RADIUS server.

**NOTE:** The **Secondary Server** section is only visible if you selected the Enable backup RADIUS server check box earlier.

- IP Address: Type the IP address of the secondary AAA server.

**NOTE:** The format of the IP address that you need to enter here depends on the AP IP mode that you selected when you created the AP zone (see [Creating an AP Zone](#)). If you selected **IPv4 Only**, enter an IPv4 address. If you selected **IPv6 Only**, enter an IPv6 address. Ensure that the IP address of the AAA server is the same in the primary server and the secondary server.

- Port: Type the port number of the secondary AAA server port number. The default RADIUS server port number is 1812 and the default RADIUS Accounting server port number is 1813.
- Shared Secret: Type the AAA shared secret.
- Confirm Secret: Retype the shared secret to confirm.

6. Click Create New.

You have completed creating an AAA server for the AP zone.



**Create New AAA Server**

General Options

Name: \*

Description:

Type: \*  RADIUS  RADIUS Accounting  Active Directory  LDAP

Backup RADIUS:  Enable Secondary Server

Primary Server

IP Address: \*

Port: \* 1812

Shared Secret: \*

Confirm Secret: \*

Secondary Server

IP Address: \*

Port: \* 1812

Shared Secret: \*

Confirm Secret: \*

OK Cancel

Figure 19: The Create New AAA Server form

## Testing an AAA Server

Follow these steps to test if an AAA server that you have created in the controller is functioning.

1. On the **AAA Servers** page, click Test AAA.  
The **Test AAA Servers** form appears.
2. In **Name**, select the name of the AAA server that you want to test.
3. In **Protocol**, select the Password Authentication Protocol (PAP), or the Challenge Handshake Authentication Protocol (CHAP) to authenticate the AAA server.
4. In **User Name**, type the user name for your AAA server account.
5. In **Password**, type your AAA server password.
6. Click **Test**.

### NOTE:

If the AP and RADIUS server are behind the NAT server, **Testing AAA Servers** fails as the controller is unable to access the AAA server you created.

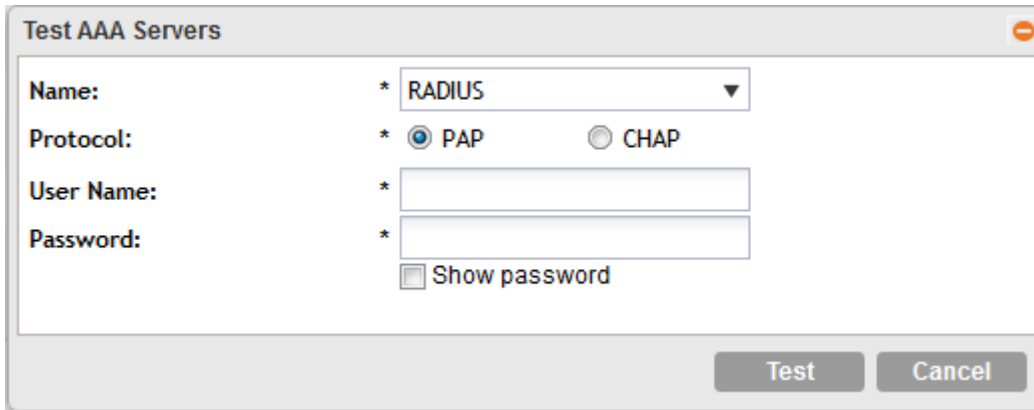


Figure 20: Testing an AAA server

## Deleting an AAA Server

You can delete a single or multiple AAA servers simultaneously.

1. To delete a single AAA server, follow these steps:
  - a) Go to the **AAA Servers** page for a specific AP zone.
  - b) From the list of existing AAA servers, locate the service that you want to delete.
  - c) Under the **Actions** column, click the icon that is in the same row as the AAA server.

A confirmation message appears.

- d) Click Yes.

The page refreshes and the AAA server that you deleted disappears from the list.

2. To delete multiple AAA servers simultaneously, follow these steps:
  - a) Go to the **AAA Services** page for a specific AP zone.
  - b) From the list of existing AAA servers, locate the services that you want to delete.
  - c) Select the check boxes before the servers that you want delete.
  - d) Click Delete Selected.

A confirmation message appears.

3. Click Yes.

The page refreshes and the AAA servers that you deleted disappears from the list.

## Working with Hotspot (WISPr) Portals

**NOTE:** If you do not want to provide a hotspot portal to users, skip this section.

This section describes the basic settings that you need to configure to include a hotspot service in the zone template. If you need more information about hotspots, including third party prerequisites, see [Creating and Managing Hotspots](#) on page 267.

## Creating a Hotspot Portal

Settings that you need to configure a hotspot service in the zone template.

Follow these steps to configure the hotspot service of the zone template.

1. Click Configuration > AP Zones.
2. On the **AP Zone List** page, click the AP zone for which you want to create a hotspot service.
3. On the sidebar, click Hotspot (WISPr).

The **Hotspot (WISPr) Portal** page appears.

4. Click Create New.

The form for creating a new hotspot portal appears.

5. In the **General Options** section, configure the following options:

- Name: Type a name for the hotspot portal.
- Description: Type a description for the hotspot portal.

6. In the **Redirection** section, configure the following options:

- Smart Client Support: Select one of the following options:
  - None: Select this option to disable Smart Client support on the hotspot portal.
  - Enable: Selection this option to enable Smart Client support.
  - Only Smart Client Allowed: Select this option to allow only Smart Clients to connect to the hotspot portal. For more information, see [Configuring Smart Client Support](#) on page 279.
- Logon URL: Type the URL of the subscriber portal (the page where hotspot users can log in to access the service). For more information, see [Configuring the Hotspot Logon URL](#) on page 279.
- Start Page: Set where users will be redirected after they log in successfully:
  - Redirect to the URL that user intends to visit: You could redirect users to the page that they want to visit.
  - Redirect to the following URL: You could set a different page where users will be redirected (for example, your company website).

7. In the **User Session** section, configure the following options:

- Session Timeout: Set a time limit (in minutes) after which users will be disconnected from the hotspot portal and will be required to log on again.
- Grace Period: Set the time period (in minutes) during which disconnected users are allowed access to the hotspot portal without having to log on again.

8. In the **Location Information** section, configure the following options:

- Location ID: Type the ISO and ITU country and area code that the AP includes in accounting and authentication requests. The required code includes:
  - isocc (ISO-country-code): The ISO country code that the AP includes in RADIUS authentication and accounting requests.

- cc (country-code): The ITU country code that the AP includes in RADIUS authentication and accounting requests.
- ac (area-code): The ITU area code that the AP includes in RADIUS authentication and accounting requests.
- network

The following is an example of what the Location ID entry should look like:

```
isocc=us,cc=1,ac=408,network=RuckusWireless
```

- Location Name: Type the name of the location of the hotspot portal.

**9. In **Walled Garden**, click Create New to add a walled garden.**

A walled garden is a limited environment to which an unauthenticated user is given access for the purpose of setting up an account.

**10. In the box provided, type a URL or IP address to which you want to grant unauthenticated users access.**

You can add up to 128 network destinations to the walled garden. Network destinations can be any of the following:

- IP address (for example, 10.11.12.13)
- IP range (for example, 10.11.12.13-10.11.12.15)
- Classless Inter-Domain Routing or CIDR (for example, 10.11.12.100/28)
- IP address and mask (for example, 10.11.12.13 255.255.255.0)
- Exact website address (for example, www.ruckuswireless.com)
- Website address with regular expression (for example, \*.ruckuswireless.com, \*.com, \*)

After the account is established, the user is allowed out of the walled garden. URLs will be resolved to IP addresses. Users will not be able to click through to other URLs that may be presented on a page if that page is hosted on a server with a different IP address. Avoid using common URLs that are translated into many IP addresses (such as `www.yahoo.com`), as users may be redirected to re-authenticate when they navigate through the page.

**11. Click Create New.**

You have completed configuring a hotspot portal of the AP zone. For additional steps that you need to perform to ensure that the hotspot portal works, see [Creating and Managing Hotspots](#) on page 267.

**Create New Hotspot Portal**

**General Options**

Portal Name: \*

Portal Description:

**Redirection**

Smart Client Support:  None  
 Enable  
 Only Smart Client Allowed

Logon URL:  Internal  
 External

Redirect unauthenticated user to the URL for authentication. \*

Redirected MAC Format: \* AA:BB:CC:DD:EE:FF (format used for including client's MAC inside redirected URL request)

Start Page: After user is authenticated,  
 Redirect to the URL that user intends to visit.  
 Redirect to the following URL:  
\*

**User Session**

Session Timeout: \* 1440 Minutes (2 - 14400)

Grace Period: \* 60 Minutes (1 - 14399)

**Location Information**

Location ID:  (example: isoc=us,cc=1,ac=408,network=ACMEWISP\_NewarkAirport)

Location Name:  (example: ACMEWISP,Gate\_14\_Terminal\_C\_of\_Newark\_Airport)

Walled Garden

OK Cancel

Figure 21: The Create New Hotspot Portal form

## Deleting a Hotspot Portal

You can delete a single or multiple hotspot portals simultaneously.

1. To delete a single hotspot portal, follow these steps:

- Go to the **Hotspot (WISPr)** page for a specific AP zone.
- From the list of existing hotspot portals, locate the portal that you want to delete.
- Under the **Actions** column, click the icon that is in the same row as the hotspot portal.

A confirmation message appears.

d) Click Yes.

The page refreshes and the hotspot portal that you deleted disappears from the list.

2. To delete multiple hotspot portals simultaneously, follow these steps:

- Go to the **Hotspot (WISPr)** page for a specific AP zone.
- From the list of existing hotspot portals, locate the hotspots that you want to delete.
- Select the check boxes before the hotspots that you want delete.
- Click Delete Selected.

A confirmation message appears.

e) Click Yes.

The page refreshes and the hotspot portals that you deleted disappear from the list.

## Working with Guest Access Portals

Using the controller's guest access features, you can provide visitors to your organization limited access to a guest WLAN with configurable guest policies.

The following sections describe how to configure guest WLANs and access policies that control guest use of your network.

### Creating a Guest Access Portal

Each guest WLAN must be associated with a guest access portal, which defines the behavior of the guest WLAN interface.

Follow these steps to create a guest access portal.

1. Click **Configuration > AP Zones**.

2. On the **AP Zone List** page, click the AP zone for which you want to create a guest access portal.

The **Guest Access Portal** page appears.

3. Click **Create New**.

The **Create New Guest Access Portal** form appears.

4. In **General Options**, configure the following:

- **Portal Name:** Type a name for the guest access portal that you are creating.
- **Portal Description:** Type a short description of the guest access portal.
- **Language:** Select the display language to use for the buttons on the guest access logon page.

5. In **Redirection**, select where to redirect the user after successfully completing authentication.

- **Redirect to the URL that the user intends to visit:** Allows the guest user to continue to their destination without redirection.
- **Redirect to the following URL:** Redirect the user to a specified web page (entered into the text box) prior to forwarding them to their destination. When guest users land on this page, they are shown the expiration time for their guest pass.

6. In **Guest Access**, configure the following options:

- **Guest Pass SMS Gateway:** You can deliver the guest pass to the user using Short Message Service (SMS). But first, you need to configure an SMS server. For more information, see [Configuring an SMS Server](#) on page 170. If you previously configured an SMS server, you can select it here or you can click **Disabled**.
- **Terms And Conditions:** To require users to read and accept your terms and conditions prior to use of the guest hotspot, select the **Show Terms And Conditions** check box. The box below, which contains the default Terms of Use text, becomes editable. Edit the text or leave it unchanged to use the default text.
- **Web Portal Logo:** By default, the guest hotspot logon page displays the Ruckus Wireless logo. To use your own logo, click the Upload button, select your logo (recommended size is 138 x 40 pixels, maximum file size is 20KB), and then click Upload.

- **Web Portal Title:** Type your own guest hotspot welcome text or accept the default welcome text ("Welcome to the Guest Access login page").

7. In **User Session**, configure the following:

- **Session Timeout:** Specify a time limit after which users will be disconnected and required to log on again.
- **Grace Period:** Set the time period during which clients will not need to re-authenticate after getting disconnected from the hotspot. Enter a number (in minutes) between 1 and 14399.

8. Click **OK**.

You have completed creating a guest access portal.

The screenshot shows the 'Create New Guest Access Portal' configuration interface. It includes sections for 'General Options' (Portal Name, Portal Description, Language), 'Redirection' (Start Page options), and 'Guest Access' (SMS Gateway, Terms and Conditions, Logo upload, and Web Portal Title).

Figure 22: Creating a guest access portal

## Viewing Guest Access Portals

Using the controller's guest access features, you can provide visitors to your organization limited access to a guest WLAN with configurable guest policies.

Each guest WLAN must be associated with a guest access portal, which defines the behavior of the guest WLAN interface.. Follow these steps to view a list of existing guest access portals.

1. Click Configuration > AP Zones.
2. On the **AP Zone List** page, click the AP zone for which you are created the guest access portals.
3. On the sidebar, click Guest Access.

The **Guest Access Portal** page appears and displays all existing guest access portals and their basic settings are shown, including the following:

- Name

- Description
  - Actions (that you can perform)
4. To view or update the settings of a guest access portal, click the guest access portal name. You have completed viewing the existing guest access portals.

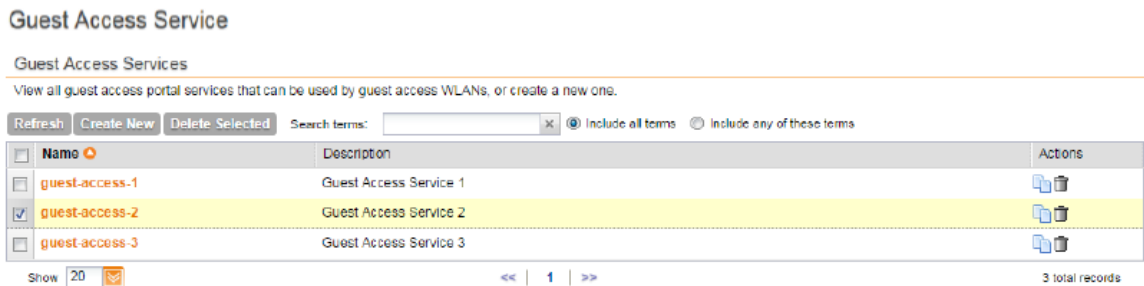


Figure 23: Viewing guest access portals

## Deleting Guest Access Portals

Follow these steps to delete guest access portals.

1. On the **AP Zone List** page, click the AP zone for which you created the guest access portal.
2. On the sidebar, click Guest Access.

The **Guest Access Portal** page appears.

3. Locate the service or services that you want to delete.
4. Select the check boxes (first column) for the services that you want to delete.
5. Click Delete Selected.

The services that you selected disappear from the list.

You have completed deleting guest access portals.

**NOTE:** If you are deleting a single guest access portal, you can also click the icon (under the Actions column) that is in the same row as the service that you want to delete.

## Working with Web Authentication Portals

A web authentication portal (also known as a “captive portal”) redirects users to a logon web page the first time they connect to a WLAN, and requires them to log on before granting access to use the WLAN.

Creating and configuring a web authentication portal requires the following steps:



## Adding an AAA Server for the Web Authentication Portal

Add an AAA server that the web authentication portal can use to authenticate users. For instructions on how to add an AAA server to the controller, see [Creating an AAA Server](#).

## Creating a Web Authentication Portal

A web authentication portal (also known as a “captive portal”) redirects users to a logon web page the first time they connect to a WLAN, and requires them to log on before granting access to use the WLAN.

Follow these steps to create a web authentication portal.

1. Go to Configuration > AP Zones.
2. Click the AP zone for which you want to create a web authentication portal.
3. On the AP Zones submenu, click Web Authentication.

The **Web Authentication Portal** page appears.

4. Click Create New.

The **Create New Web Authentication Portal** form appears.

5. In **General Options**, configure the following options:

- Portal Name: Type a name for the web authentication portal that you are creating.
- Portal Description: Type a brief description of the portal.
- Language: Select the display language that you want to use on the web authentication portal.

6. In **Redirection**, select where to redirect the user after successfully completing authentication.

- Redirect to the URL that the user intends to visit: Allows the guest user to continue to their destination without redirection.
- Redirect to the following URL: Redirect the user to a specified web page (entered into the text box) prior to forwarding them to their destination. When guest users land on this page, they are shown the expiration time for their guest pass.

7. In **User Session**, configure the following:

- Session Timeout: Set the time (in minutes) after which inactive users will be disconnected and required to log in again.
- Grace Period: Set the time period (in minutes) during which disconnected users are allowed access to the hotspot service without having to log on again.

8. Click OK.

You have completed creating a web authentication portal.

**Create New Web Authentication Portal**

**General Options**

Portal Name: \*

Portal Description:

Language: \* English ▼

**Redirection**

Start Page: After user is authenticated,

Redirect to the URL that user intends to visit.

Redirect to the following URL:

\*

**User Session**

Session Timeout: \*  Minutes (2-14400)

Grace Period: \*  Minutes (1-14399)

OK Cancel

Figure 24: The Create New Web Authentication Portal page

## Creating a WLAN for the Web Authentication Portal

A web authentication portal (also known as a “captive portal”) redirects users to a logon web page the first time they connect to a WLAN, and requires them to log on before granting access to use the WLAN.

Follow these steps to create a WLAN that you can use for a web authentication portal.

1. Go to Configuration>AP Zones>WLANs.
2. In the **WLAN Configuration** section, click Create New.
3. In **General Options**, configure the following:
  - Name
  - SSID
  - Description
4. In **Authentication Type**, click Web Authentication.
5. In **Authentication & Accounting Server**, select the RADIUS and/or RADIUS Accounting server that you created earlier in [Adding an AAA Server for the Web Authentication Portal](#).
6. In **Web Authentication**, select the web authentication portal that you created earlier in [Creating a Web Authentication Portal](#).

This service contains, among others, the start page where users will be redirected when they associate with this WLAN.

7. Configure the remaining WLAN options as desired.

For information on these options, see [Creating a WLAN](#).

8. Click OK.

You have completed creating a WLAN for web authentication.

After you create a WLAN that will be used for web authentication, you must then provide all users with the URL to your **logon** page. After they discover the WLAN on their wireless device or laptop, they open their browser, connect to the **logon** page and enter the required login information.

**Create New WLAN Configuration**

**General Options**

Name: \*

SSID: \*

HESSID:

Description:

**WLAN Usage**

Access Network:  Tunnel WLAN traffic through Ruckus GRE

Authentication Type: \*  Standard usage (For most regular wireless networks)

Hotspot (WISPr)

Guest Access + Hotspot 2.0 Onboarding

Web Authentication

Hotspot 2.0 Access

Hotspot 2.0 Secure Onboarding (OSEN)

WeChat

**Authentication Options**

Method: \*  Open  802.1x EAP  MAC Address

**Encryption Options**

Figure 25: Creating a WLAN to provide web authentication

## Working with Hotspot 2.0 Services

Hotspot 2.0 is a newer Wi-Fi Alliance specification that allows for automated roaming between service provider access points when both the client and access gateway support the newer protocol.

Hotspot 2.0 aims to improve the experience of mobile users when selecting and joining a Wi-Fi hotspot by providing information to the station prior to association. This information can then be

used by the client to automatically select an appropriate network based on the services provided and the conditions under which the user can access them. In this way, rather than being presented with a list of largely meaningless SSIDs to choose from, the Hotspot 2.0 client can automatically select and authenticate to an SSID based on the client's configuration and services offered, or allow the user to manually select an SSID for which the user has login credentials.

The Hotspot 2.0 implementation on the controller complies with the IEEE 802.11u standard and the Wi-Fi Alliance Hotspot 2.0 Technical Specifications.

See the *Hotspot 2.0 Reference Guide* for this release for information on configuring Hotspot 2.0 services, including:

- Working with Hotspot 2.0 operator profiles
- Working with Hotspot 2.0 identity providers
- Creating a Hotspot 2.0 online signup portal

## Working with WLANs and WLAN Groups

### Creating a WLAN

An AP zone functions as a way of grouping Ruckus Wireless APs and applying settings including WLANs to these groups of Ruckus Wireless APs. Each AP zone can include up to six WLAN services.

Follow these steps to create a WLAN for an AP zone.

1. Click **Configuration > AP Zones**.
2. On the **AP Zone List** page, click the AP zone for which you want to create a WLAN service.
3. On the sidebar, click **WLAN**.

The **WLAN Configuration** page appears.

4. In the **WLAN Configuration** section, click Create New.

The form for creating a new WLAN service appears.

5. In the **General Options** section, configure the following options.
  - **Name/SSID:** Type a short name (two to 32 alphanumeric characters) for this WLAN. In general, the WLAN name is the same as the advertised SSID (the name of the wireless network as displayed in the client's wireless configuration program). However, you can also separate the SSID from the WLAN name by entering a name for the WLAN in the first field, and a broadcast SSID in the second field. In this way, you can advertise the same SSID in multiple locations (controlled by the same controller) while still being able to manage the different WLANs independently.
  - **HESSID:** Type the homogenous extended service set identifier (HESSID). The HESSID is a 6-octet MAC address that identifies the homogeneous ESS. The HESSID value must be identical to one of the BSSIDs in the homogeneous ESS.
  - **Description:** Type a brief description of the qualifications/purpose for this WLAN (for example, Engineering or Voice).

6. In **WLAN Usage**, configure the following:

- In Access Network, select the **Tunnel WLAN traffic through Ruckus GRE** check box if you want to tunnel the traffic from this WLAN back to the controller. Tunnel mode enables wireless clients to roam across different APs on different subnets. If the WLAN has clients that require uninterrupted wireless connection (for example, VoIP devices), Ruckus Wireless recommends enabling tunnel mode. When you enable this option, you need to select core network for tunneling WLAN traffic back to the controller.

If you select the check box, all the WLAN traffic tunnels through the SoftGRE from the WLAN back to the controller using Standard, Hotspot 2.0 Access, and WeChat authentications types. If you do not select the check box, WLAN traffic tunnels through the SoftGRE from the WLAN back to the controller using all of the authentication types.

**NOTE:** AP zones with IPv6 network configuration settings support tunneling WLAN traffic through Ruckus GRE tunnel type.

- In Core Network Type (only visible if you selected the **Tunnel WLAN traffic through Ruckus GRE** check box), select one of the following core network types:
  - Bridge
  - L3oGRE
  - L2oGRE
  - TTG+PDG
  - PMIPv6
  - Mixed Tunnel Mode
- In **Authentication Type**, click one of the following options:
  - Standard usage (For most regular wireless networks): This is a regular WLAN suitable for most wireless networks.
  - Hotspot (WISPr): Click this option if you want to use a hotspot portal that you previously created. For instructions on how to create a hotspot service, see [Working with Hotspot \(WISPr\) Portals](#).

**NOTE:** Hotspot (WISPr) applies to WLAN traffic that is tunneled and not tunneled.

- Guest Access: Click this option if you want guest users to use this WLAN. After you create a WLAN for guest access, you can generate guest passes. For more information, see [Working with Guest Users](#) on page 324.

**NOTE:** For more information about Hotspot 2.0 online signup, see the Hotspot 2.0 Reference Guide for this release.

- Web Authentication: Click this option if you want to require all WLAN users to complete a web-based logon to this network every time they attempt to connect. See [Working with Web Authentication Portals](#).
- Hotspot 2.0 Access: Click this option if you want a Hotspot 2.0 operator profile that you previously created to use this WLAN. See [Working with Hotspot 2.0 Services](#).

- Hotspot 2.0 Secure Onboarding (OSEN): Click this option if you want to use this WLAN for Hotspot 2.0 OSEN. See the Hotspot 2.0 Reference Guide for this release for more information.
- WeChat: Click this option if you want the WLAN usage through WeChat.

**NOTE:** Authentication types such as WeChat, Web Authentication and Guest Access are not supported by APs in IPv6 mode.

**7. In Authentication Options**, click the authentication method by which users will be authenticated prior to gaining access to the WLAN.

The level of security should be determined by the purpose of the WLAN you are creating.

- Open (Default): No authentication mechanism is applied to connections. If WPA or WPA2 encryption is used, this implies WPA-PSK authentication.
- 802.1x EAP: A very secure authentication/encryption method that requires a back-end authentication server, such as a RADIUS server. Your choice mostly depends on the types of authentication the client devices support and your local network authentication environment.
- MAC Address: Authenticate clients by MAC address. MAC address authentication requires a RADIUS server and uses the client MAC address as the user logon name and password. You have two options for the MAC address format to use for authenticating clients:
  - MAC Authentication: The default password is the device's MAC address. If you want to set your own authentication password, select the **Use user defined text as authentication password (default is device MAC address)** check box, and then type the password in the box provided.
  - MAC Address Format: Select the MAC address format that you want APs to use when sending authentication requests to the RADIUS server. Select one of the following supported MAC address formats:

aabbccddeeff (Default format. For example, 0010a42319c0)

AA-BB-CC-DD-EE-FF

AA:BB:CC:DD:EE:FF

AABBCCDDEEFF

aa-bb-cc-dd-ee-ff

aa:bb:cc:dd:ee:ff

**8. In Encryption Options**, select an encryption method to use.

WPA and WPA2 are both encryption methods certified by the Wi-Fi Alliance and are the recommended encryption methods. The Wi-Fi Alliance will be mandating the removal of WEP due to its security vulnerabilities, and Ruckus Wireless recommends against using WEP if possible.

- WPA2: Enhanced WPA encryption using stronger TKIP or AES encryption algorithm.

**NOTE:** Enabling WPA2 enables **Dynamic PSK** under **Options**.

- WPA-Mixed: Allows mixed networks of WPA and WPA2 compliant devices. Use this setting if your network has a mixture of older clients that only support WPA and TKIP, and newer client devices that support WPA2 and AES.
- WEP-64 (40 bits): Provides a lower level of encryption, and is less secure, using 40-bit WEP encryption.
- WEP-128 (104 bits): Provides a higher level of encryption than WEP-64, using a 104-bit key for WEP encryption. However, WEP is inherently less secure than WPA.
- None: No encryption; traffic is sent in clear text.

**NOTE:** If you set the encryption method to WEP-64 (40 bit) or WEP-128 (104 bit) and you are using an 802.11n AP for the WLAN, the AP will operate in 802.11g mode.

- Passphrase: Enter the passphrase to access the WLAN.
- 802.11r Fast Roaming: Select the check box to enable 802.11r Fast BSS Transition.

Selecting this option allows you to enter the **Mobility Domain ID**. Enter a value within the range provided (1 to 65535).

**9. In Hotspot Portal, configure the following options.**

**NOTE:** This section only appears if you clicked **Hotspot (WISPr)** in WLAN Usage>Authentication Type.

- Hotspot (WISPr) Portal: Select the hotspot that you want this WLAN to use. This option appears only when **Hotspot (WISPr)** is selected as the WLAN usage type. This hotspot portal may be the hotspot that you created in [Creating a Hotspot Portal](#).
- Bypass CNA: Select the **Enable** check box if you want to bypass the Apple CNA feature on iOS and OS X devices that connect to this WLAN. See [Bypassing Apple CNA](#) for more information.
- Authentication Service: Select the authentication server that you want to use for this WLAN. Options include Local DB, Always Accept, and any AAA servers that you previously added (see [Working with AAA Servers](#)). Additionally, if you want the controller to proxy authentication messages to the AAA server, select the Use the Controller as Proxy check box.
- Accounting Service: Select the RADIUS Accounting server that you want to use for this WLAN. You must have added a RADIUS Accounting server previously (see [Working with AAA Servers](#)). Additionally, if you want the controller to proxy accounting messages to the AAA server, select the Use the Controller as Proxy check box.

**NOTE:** Ensure that the *dictionary.ruckus* file in the AAA server at `usr/local/share/freeradius/` is the same as the one in SCG-200 or SZ100 at `/opt/ruckuswireless/wsg/conf/ttg_pdg/share`.

**10. In Guest Access Portal, configure the following options:**

**NOTE:** This section only appears if you clicked Guest Access in WLAN Usage>Authentication Type.

- Guest Access Portal: Select the guest access portal that you created earlier for this onboarding WLAN.
- Bypass CNA: Select the **Enable** check box if you want to bypass the Apple CNA feature on iOS and OS X devices that connect to this WLAN. See [Bypassing Apple CNA](#) for more information.
- Guest Authentication: Select **Guest** to require users to enter their guest credentials, or select **Always Accept** to allow users without guest credentials to authentication.
- Guest Accounting: Select the RADIUS Accounting server that you want to use for this WLAN. You must have added a RADIUS Accounting server previously (see [Working with AAA Servers](#)). Additionally, if you want the controller to proxy accounting messages to the AAA server, select the **Use the Controller as Proxy** check box.

**11.** In the **Authentication & Accounting Service** section, configure the following options:

- Web Authentication Portal: Select the web authentication portal that you created previously. See [Working with Web Authentication Portals](#) for more information.
- Bypass CNA: Select the Enable check box if you want to bypass the Apple® CNA feature on iOS and OS X® devices that connect to this WLAN. See [Bypassing Apple CNA](#) for more information.
- Authentication Service: Select the authentication server that you want to use for this WLAN. Options include Local DB, Always Accept, and any AAA servers that you previously added (see [Working with AAA Servers](#)). Additionally, if you want the controller to proxy authentication messages to the AAA server, select the Use the Controller as Proxy check box.
- Accounting Service: Select the RADIUS Accounting server that you want to use for this WLAN. You must have added a RADIUS Accounting server previously (see [Working with AAA Servers](#)). Additionally, if you want the controller to proxy accounting messages to the AAA server, select the Use the Controller as Proxy check box.

**12** In **Options**, configure the following options:

- Wireless Client Isolation: Wireless client isolation enables subnet restrictions for connected clients. Click Enable if you want to prevent wireless clients associated with the same AP from communicating with each other locally. The default value is Disable.
- Priority: Set the priority of this WLAN to Low if you would prefer that other WLAN traffic takes priority. For example, if you want to prioritize internal traffic over guest WLAN traffic, you can set the priority in the guest WLAN configuration settings to "Low." By default, all WLANs are set to high priority.
- **Dynamic PSK:** select the **Enable Dynamic PSK** check-box and enter the passphrase length to secure the WiFi network. The passphrase length is between 8 to 62 characters.

**NOTE:** Enabling the check-box displays the **DPSK Type** and **DPSK Expiration** settings to configure.

- **DPSK Type:** select the type of DPSK (Secure or Keyboard-friendly) that you want to use to secure the network



In **Secure DPSK**, the key uses a mix of all printable ASCII characters and in **Keyboard-friendly DPSK**, the key only uses letters and number.

- **DPSK Expiration:** select the time till when DPSK must be used to secure the network.  
For more information, see [Working With Dynamic PSKs](#).

**13** In **RADIUS Options**, click + (plus sign) to display the options, and then configure the following:

- **NAS ID:** Select how to the RADIUS server will identify the AP:
  - WLAN BSSID
  - AP MAC
  - User-defined
- **NAS Request Timeout:** Type the timeout period (in seconds) after, which an expected RADIUS response message is considered to have failed.
- **NAS Max Number of Retries:** Type the number of failed connection attempts after which the controller will fail over to the backup RADIUS server.
- **NAS Reconnect Primary:** If the controller fails over to the backup RADIUS server, this is the interval (in minutes) at which the controller will recheck the primary RADIUS server if it is available. The default interval is 5 minutes.
- **Called STA ID:** Use WLAN BSSID, AP MAC, AP GROUP, or NONE as the called station ID. Select one.

**NOTE:** Selecting NONE resets both Called and Calling station IDs to empty.

**14** In **Advanced Options**, configure the following options:

- **User Traffic Profile:** If you want this WLAN to use a user traffic profile that you previously created, select it from the drop-down menu. Otherwise, select System Default. For more information, see [Working with User Traffic Profiles](#) on page 185.
- **L2 Access Control:** If you want this WLAN to use an L2 access control policy that you previously created, select it from the drop-down menu. Otherwise, select Disable. For more information, see [Working with L2 Access Control Policies](#).
- **Device Policy:** If you want this WLAN to use a device policy that you previously created, select it from the drop-down menu. Otherwise, select Disable. For more information, see [Working with Device Policies](#).
- **Access VLAN:** By default, all wireless clients associated with APs that the controller is managing are segmented into a single VLAN (with VLAN ID 1). If you want to tag this WLAN traffic with a different VLAN ID, enter a valid VLAN ID (2-4094) in the box.
- **Hide SSID:** Select this check box if you do not want the ID of this WLAN advertised at any time. This will not affect performance or force the WLAN user to perform any unnecessary tasks.
- **Client Load Balancing:** To disable client load balancing on this WLAN, select the **Do not perform client load balancing for this WLAN service** check box. For more information, see [Client Load Balancing](#) on page 76.
- **Proxy ARP:** Select this check box to enable proxy ARP. When proxy ARP is enabled on a WLAN, the AP provides proxy service for stations when receiving neighbor discovery

packets (for example, ARP request and ICMPv6 Neighbor Solicit messages), and acts on behalf of the station in delivering ARP replies. When the AP receives a broadcast ARP/Neighbor Solicit request for a known host, the AP replies on behalf of the host. If the AP receives a request for an unknown host, it forwards the request at the rate limit specified.

- **Max Clients:** This option limits the number of clients that can associate with this WLAN per AP (default is 100). You can also limit the total number of clients that a specific AP (or radio, on dual radio APs) will manage.
- **802.11d:** Select this check box to enable this standard on this WLAN. 802.11d provides specifications for compliance with additional regulatory domains (countries or regions) that were not defined in the original 802.11 standard. Click this option if you are operating in one of these additional regulatory domains.
- **802.11k Neighbor Report:** Select this check box to enable 802.11k neighbor reports.
- **Force DHCP:** Enable this option to force clients to obtain a valid IP address from DHCP within the specified number of seconds. This prevents clients configured with a static IP address from connecting to the WLAN. Additionally, if a client performs Layer 3 roaming between different subnets, in some cases the client sticks to the former IP address. This mechanism optimizes the roaming experience by forcing clients to request a new IP address.
- **DHCP Option 82:** Select the **Enable DHCP Option 82** check box to enable this feature. When this feature is enabled and an AP receives a DHCP request from a wireless client, the AP will encapsulate additional information (such as VLAN ID, AP name, SSID and MAC address) into the DHCP request packets before forwarding them to the DHCP server. The DHCP server can then use this information to allocate an IP address to the client from a particular DHCP pool based on these parameters.
- **Client TX/RX Statistics:** Select the **Ignore statistics from unauthorized clients** check box if you do not want the controller to monitor traffic statistics for unauthorized clients.
- **Inactivity Timeout:** Select this check box and enter a value in seconds (60 to 600) after which idle clients will be disconnected.
- **Client Fingerprinting:** By selecting this check box, the controller will attempt to identify client devices by their operating system, device type and host name, if available. This makes identifying client devices easier on the **Dashboard**, **Monitor** and **Client Details** pages.

**NOTE:** Enabling this option for Kumo devices ensure that the client information is also sent as a RADIUS attribute (access request ) for Hotspot WISPr WLANs.

- **OFDM Only:** Select the check box to force clients associated with this WLAN to use only Orthogonal Frequency Division Multiplexing (OFDM) to transmit data. OFDM-only allows the client to increase management frame transmission speed from CCK rates to OFDM rates. This feature is implemented per WLAN and only affects the 2.4GHz radio.
- **BSS Min Rate:** Select this check box to set the bss rates of management frames from default rates (CCK rates for 2.4G or OFDM rate – 6Mbps for 5G] to the desired rates. By default, BSS Min Rate is disabled.

**NOTE:** OFDM-only takes higher priority than BSS-minrate. However, OFDM-only relies on BSS-minrate to adjust its rate for management frames.

- **Mgmt Tx Rate:** To set the transmit rate for management frame, select a value (in Mbps) from the drop-down list.
- **DiffServ Profile:** To apply a DiffServ profile to this WLAN service, select a profile from the drop-down menu. Select **Disable** from the drop-down menu if you want to disable the profile for the WLAN service.
- **Service Schedule:** Use the Service Schedule tool to control which hours of the day, or days of the week to enable/disable WLAN service. Options include:
  - **Always On:** Click this enable this WLAN at all times.
  - **Always Off:** Click this option to disable the WLAN service at all times.
  - **Specific:** Click this to set specific hours during which this WLAN will be enabled. For example, a WLAN for student use at a school can be configured to provide wireless access only during school hours. Click on a day of the week to enable/disable this WLAN for the entire day. Colored cells indicate WLAN enabled. Click and drag to select specific times of day. You can also disable a WLAN temporarily for testing purposes, for example.
- **Band Balancing:** To disable band balancing on this WLAN, select the Do not perform band balancing for this WLAN service check box. For more information, see [Band Balancing](#) on page 77.
- **QoS Map Set:** All networks have their own network layer packet marking practices and it would vary from one network to the other. Therefore, enabling **QOS Map Set** remaps the network layer packet marking practice with a common service level.

Select the **QOS Map Set** check-box to map the Differentiated Services Code Point (DSCP) range and exception values to the 802.11 packet User Priority (UP).

UP value ranges from 0 – 7 and DSCP value from 0 - 63.

**NOTE:**

A UP with 255 as its DSCP low and high value is not used.

The DSCP exception value is unique to a UP and cannot be assigned to another UP.

- **SSID Rate Limiting:** Select the **Enable** check-box to enable uplink and downlink, and type the limiting rate for them.
- **DNS Server Profile:** To apply a DNS Server profile to this WLAN service, select a profile from the drop-down menu. Select **Disable** from the drop-down menu if you want to disable the DNS Server profile for the WLAN service.

**15** Click **OK** at the bottom of the form.

You have completed creating and configuring a WLAN service of the AP zone.

The screenshot shows the 'Create New WLAN Configuration' form. It is divided into three main sections: 'General Options', 'WLAN Usage', and 'Authentication Options'.  
- **General Options:** Contains input fields for 'Name', 'SSID', 'HESSID', and 'Description'.  
- **WLAN Usage:** Includes a checkbox for 'Tunnel WLAN traffic through Ruckus GRE'. The 'Authentication Type' is set to 'Standard usage (For most regular wireless networks)'. Other options include 'Hotspot (WISPr)', 'Guest Access' (which is selected), 'Web Authentication', 'Hotspot 2.0 Access', 'Hotspot 2.0 Secure Onboarding (OSEN)', and 'WeChat'.  
- **Authentication Options:** The 'Method' is set to 'Open'. Other options are '802.1x EAP' and 'MAC Address'.

Figure 26: Top half of the Create New WLAN Configuration form

### Channel Mode

Channel mode is a method of statistically picking the most potent channel for an AP.

Some countries restrict certain 5GHz channels to indoor use only. For instance, Germany restricts channels in the 5.15GHz to 5.25GHz band to indoor use. When ZoneFlex Outdoor APs and Bridges with 5GHz radios (ZoneFlex 7762, 7762-S, 7762-T, 7761-CM and 7731) are set to a country code where these restrictions apply, the AP or Bridge can no longer be set to an indoor-only channel and will no longer select from amongst a channel set that includes these indoor-only channels when SmartSelect or Auto Channel selection is used, unless the administrator configures the AP to allow use of these channels.

For instance, if the AP is installed in a challenging indoor environment (such as a warehouse), the administrator may want to allow the AP to use an indoor-only channel. These channels can be enabled for use through the AP CLI or the controller web interface.

### Client Load Balancing

Enabling load balancing can improve WLAN performance by helping to spread the wireless client load between nearby access points, so that one AP does not get overloaded while another sits idle. The load balancing feature can be controlled from within the controller web interface to balance the number of clients per radio on adjacent APs.

“Adjacent APs” are determined by the controller at startup by measuring the RSSI during channel scans. After startup, the controller uses subsequent scans to update the list of adjacent radios periodically and when a new AP sends its first scan report. When an AP leaves, the controller immediately updates the list of adjacent radios and refreshes the client limits at each affected AP.

Once the controller is aware of which APs are adjacent to each other, it begins managing the client load by sending the configured client limits to the APs. These limits are “soft values” that can be exceeded in several scenarios, including:

1. When a client’s signal is so weak that it may not be able to support a link with another AP
2. When a client’s signal is so strong that it really belongs on this AP.

The APs maintain these configured client limits and enforce them once they reach the limits by withholding probe responses and authentication responses on any radio that has reached its limit.

### Key Points About Client Load Balancing

Before you enable load balancing, keep the following considerations in mind:

- The load balancing rules apply only to client devices; the AP always responds to another AP that is attempting to set up or maintain a mesh network.
- Load balancing does not disassociate clients already connected.
- Load balancing takes action before a client association request, reducing the chance of client misbehavior.
- The process does not require any time-critical interaction between APs and the controller.
- Provides control of adjacent AP distance with safeguards against abandoning clients.
- Can be disabled on a per-WLAN basis. For instance, on a voice WLAN, load balancing may not be desired due to voice roaming considerations.
- Background scanning must be enabled on the WLAN for load balancing to work.

### Band Balancing

Band balancing balances the client load on radios by distributing clients between the 2.4GHz and 5GHz radios. This feature is enabled by default and set to a target of 25% of clients connecting to the 2.4GHz band. To balance the load on a radio, the AP encourages dual-band clients to connect to the 5GHz band when the configured percentage threshold is reached.

### Bypassing Apple CNA

Some Apple iOS and OS X clients include a feature called Captive Network Assistant (CNA), which allows clients to connect to an open captive portal WLAN without displaying the logon page.

When a client connects to a wireless network, the CNA feature launches a pre-browser login utility and it sends a request to a success page on the Apple website. If the success page is returned, the device assumes it has network connectivity and no action is taken. However, this login utility is not a fully functional browser, and does not support HTML, HTML5, PHP or other embedded video. In some situations, the ability to skip the login page for open WLANs is a benefit. However, for other guest or public access designs, the lack of ability to control the entire web authentication process is not desirable.

The controller provides an option to work around the Apple CNA feature if it is not desirable for your specific deployment. With CNA bypass enabled, captive portal (web-based authentication) logon must be performed by opening a browser to any unauthenticated page (HTTP) to get redirected to the logon page.

## Portal-based WLANs

There are many types of portal-based WLANs and they can be distinguished based on where the user credentials are stored, and where the portal page is hosted.

**Table 7: Portal-based WLANs**

WLAN Type	User Credential	Portal on which WLAN is Hosted
Guest	Guest passes on the controller	AP
Hotspot (WISPr)	RADIUS server. LDAP/Active Directory from SmartZone release 3.2 and later	External portal server or internal portal on the controller
Web Auth	RADIUS/LDAP/Active Directory	AP

Guest and WebAuth WLAN portals are hosted on the controller AP with limited customization. WISPr WLANs are usually hosted on external portal servers providing the flexibility to customize. WISPr WLANs allow for sophisticated customization such as providing a customized login page which could include locale information, advertisements etc.

WISPr WLANs can also be configured to bypass the authentication portal such that if an end user device's MAC address (as a credential) is stored on a RADIUS server, there is no need to redirect the end user to the portal server for authentication.

## Characteristics of portal-based WLANs

Portal-based WLANs have the following characteristics:

- WebAuth WLAN
  - Does not provide an option to modify the portal (WYSIWYG)
  - User authentication is done by the RADIUS server, LDAP and Active Directory
  - Allows redirecting user web pages
- Guest WLAN
  - Provides an option to modify the portal elements such as the logo, Terms and Conditions, title etc
  - User authentication is by using guest passphrases or select the **Always Accepted** option
  - Allows redirecting user web pages
  - Does not possess a local database, LDAP, Active Directory or RADIUS server
- Hotspot (WISPr) WLAN
  - Internal Portal
    - Provides an option to modify the portal elements such as the logo, Terms and Conditions, title etc
    - Allows redirecting user web pages

- User authentication is by the local database, LDAP, Active Directory, RADIUS server or rendered by selecting the **Always Accepted** option
- Supports the Walled Garden approach to allow user access to specific areas within the network

#### External Portal

- Allows customization of the portal pages through external services
- Supports Northbound Portal Interface for authentication
- User authentication is by the local database, LDAP, Active Directory, RADIUS server or rendered by selecting the **Always Accepted** option
- Supports the Walled Garden approach to allow user access to specific areas within the network
- Allows redirecting user web pages

### Rate Limiting Ranges for Policies

You can define and apply rate limit values for user devices to control the data rate and types of network traffic the device transmits.

#### NOTE:

For SmartZone release 3.4 and 3.2.x, the APs support the following rate limiting values:

- 0.10Mbps
- 0.25Mbps - 20.00Mbps (increments by 0.25Mbps)
- 21.00Mbps - 200.00Mbps (increments by 1.00Mbps)

For example, typing 6.45 Mbps maps to the closest predefined rate value, so 6.45Mbps will be rendered as 6.50Mbps.

#### NOTE:

For SmartZone release 3.1.x, the APs support the following rate limiting values:

- 0.10Mbps
- 0.25Mbps - 20.00Mbps (increments by 0.25Mbps)
- 30.00Mbps
- 40.00Mbps
- 50.00Mbps

For example, typing 31.50 Mbps maps to the closest predefined rate value, so 31.50 Mbps will be rendered as 40 Mbps. Any rate greater than 50.00Mbps would be mapped to the maximum rate which is 50.00Mbps.

**Table 8: Rate Limiting ranges for different controller policies**

Policy	Global or Zone	Rate limit range for zone running SmartZone 3.4	Rate limit range for zone running SmartZone 3.2.x	Rate limit range for zone running SmartZone 3.1.x
Device Policy	Zone	0.1 Mbps to 200 Mbps  Support uni-direction (Uplink and Downlink need not to be enabled or disabled at the same time)	0.1 Mbps to 200 Mbps.  No support for uni-direction (Uplink and Downlink must to be enabled or disabled at the same time)	0.1 Mbps to 200 Mbps. But Any rate greater than 50Mbps will be mapped to 50 Mbps implicitly on the AP side when the rate is applied.  No support for uni-direction
User Traffic Profile	Global	0.1 Mbps to 200 Mbps  No support for uni-direction because this is Global profile that is used by 3.2.x and 3.1.x APs.	0.1 Mbps to 200 Mbps  No support for uni-direction	0.1 Mbps to 200 Mbps. But Any rate greater than 50Mbps will be mapped to 50 Mbps implicitly on the AP side when the rate is applied.  No support for uni-direction

### Working with WLAN Groups

A WLAN group is a way of specifying which APs or AP groups provide which WLAN services. If your wireless network covers a large physical environment (for example, multi-floor or multi-building office) and you want to provide different WLAN services to different areas of your environment, you can use WLAN groups to do this.

For example, if your wireless network covers three building floors (1st floor to 3rd floor) and you need to provide wireless access to visitors on the 1st floor, you can do the following:

1. Create a WLAN service (for example, “Guest Only Service”) that provides guest-level access only.



2. Create a WLAN group (for example, “Guest Only Group”), and then assign “Guest Only Service” (WLAN service) to “Guest Only Group” (WLAN group).
3. Assign APs on the 1st Floor (where visitors need wireless access) to your “Guest Only Group”.

Any wireless client that associates with APs assigned to the “Guest Only Group” will get the guest-level access privileges defined in your “Guest Only Service.” APs on the 2nd and 3rd floors can remain assigned to the default WLAN Group and provide normal-level access.

### Notes About WLAN Groups

Before you start using WLAN groups to provision WLAN settings to APs or AP groups, take note of the following important notes:

- Creating WLAN groups is optional. If you do not need to provide different WLAN services to different areas in your environment, you do not need to create a WLAN group.
- A default WLAN group called “default” exists. The first 27 WLANs that you create are automatically assigned to this default WLAN group.
- A WLAN group can include a maximum of 27 member WLANs. For dual radio APs, each radio can be assigned to only one WLAN group (single radio APs can be assigned to only one WLAN group).

### Creating a WLAN Group

.Creating WLAN groups is optional. If you do not need to provide different WLAN services to different areas in your environment, you do not need to create a WLAN group.

Follow these steps to create a WLAN group.

1. Go to Configuration>AP Zones.
2. Click the AP zone for which you want to create a device access policy.
3. In the AP Zones submenu, click WLAN.

The **WLAN Services & Groups** page appears.

4. Look for the **WLAN Group Configuration** section.
5. Click Create New.
6. In Group Name, type a descriptive name that you want to assign to this WLAN group.

For example, if this WLAN will contain WLANs that are designated for guest users, you can name this as Guest WLAN Group.

7. In Description (optional), type some notes or comments about this group.
8. Under **WLAN List**, select the check boxes for the WLANs that you want to be part of this WLAN group. The VLAN Override and NAS-ID columns for the selected WLANs become active.
9. In the **VLAN override settings**, choose whether to override the VLAN configured for each member WLAN. Available options include:
  - No Change: Click this option if you want the WLAN to keep the same VLAN tag (default: 1).
  - Tag: Click this option to override the VLAN configured for the WLAN service.

**NOTE:** VLAN override only works when the VLAN configuration in the WLAN and WLAN group are of the same type. For example, you can override VLAN pooling only if the WLAN group is configured with the VLAN pooling override option, and when the WLAN is configured to enable VLAN pooling. Similar limitation exists for single VLAN configuration.

**10.** In the **NAS-ID settings**, choose whether to override the NAS-ID configured for each member WLAN. Available options include:

- No Change: Click this option if you want the WLAN to keep the same NAS-ID tag.
- User-defined: Click this option to override the NAS-ID that has been assigned to this WLAN service.

**11.** Click Create New.

The **Create New** form disappears and the WLAN group that you created appears in the table under WLAN Groups.

You may now assign this WLAN group to an AP or AP group.

### Viewing Existing WLAN Groups

A WLAN group is a way of specifying which APs or AP groups provide which WLAN services.

Follow these steps to view a list of existing WLAN groups.

1. Go to Configuration>AP Zones.
2. Click the AP zone for which you want to create a device access policy.
3. In the AP Zones submenu, click WLAN.

The **WLAN Services & Groups** page appears.

**4.** Look for the **WLAN Group Configuration** section.

All existing WLAN groups and their basic settings are shown, including the:

- WLAN group name
- Description
- Actions (that you can perform)

To view WLANs that belong to a particular WLAN group, click the WLAN group name.

### Deleting WLAN Groups

Follow these steps to delete WLAN groups.

1. Go to Configuration>AP Zones.
2. Click the AP zone for which you want to create a device access policy.
3. In the AP Zones submenu, click WLAN.

The **WLAN Services & Groups** page appears.

4. Scroll down to the **WLAN Group Configuration** section.
5. Locate the WLAN group or groups that you want to delete.

6. Select the check boxes (first column) for the WLAN groups that you want to delete.
7. Click Delete Selected.

The WLAN groups that you selected disappear from the list. You have completed deleting WLAN groups.

**NOTE:** If you are deleting a single WLAN group, you can also click the icon (under the Actions column) that is in the same row as the WLAN group that you want to delete.

## Working with WLAN Schedules

A WLAN schedule profile specifies the hours of the day or week during which a WLAN service will be enabled or disabled.

For example, a WLAN for student use at a school can be configured to provide wireless access only during school hours. Create a WLAN schedule profile, and then when you configure a WLAN, select the schedule profile to enable or disable the WLAN service during those hours/days.

**NOTE:** This feature will not work properly if the system does not have the correct time. To ensure that the system always maintains the correct time, configure an NTP server and point the system to the NTP server's IP address, as described in [Setting the System Time](#) on page 203..

WLAN service schedule times should be configured based on your browser's current time zone. If your browser and the target AP/WLAN are in different time zones, configure the on/off times according to the desired schedule according to your local browser. For example, if you wanted a WLAN in Los Angeles to turn on at 9 AM and your browser was set to New York time, configure the WLAN service schedule to enable the WLAN at noon. When configuring the service schedule, all times are based on your browser's time zone settings.

### Creating a WLAN Schedule Profile

Follow these steps to create a WLAN schedule profile.

1. Go to Configuration>AP Zones.
2. On the AP Zones submenu, click WLAN Scheduler.
3. Click Create New.

The **Create New WLAN Schedule Table** form appears.

4. Set a WLAN schedule.
  - To enable or disable the WLAN for an entire day, click the day of the week under the Time column.
  - To enable or disable the WLAN for specific hour of a specific day, click the squares in the table. A single square represents 30 minutes (two-15 minute blocks).

Blue-colored cells indicate the hours when the WLAN is enabled. Clear (or white) cells indicate the hours when the WLAN is disabled.

5. Click Create New.

The page refreshes, and then the schedule you created appears in the **WLAN Scheduler** section.

You have completed creating a WLAN schedule. This WLAN schedule will now appear as an option when you set the WLAN service schedule to **Specific** (see [Figure 36](#))

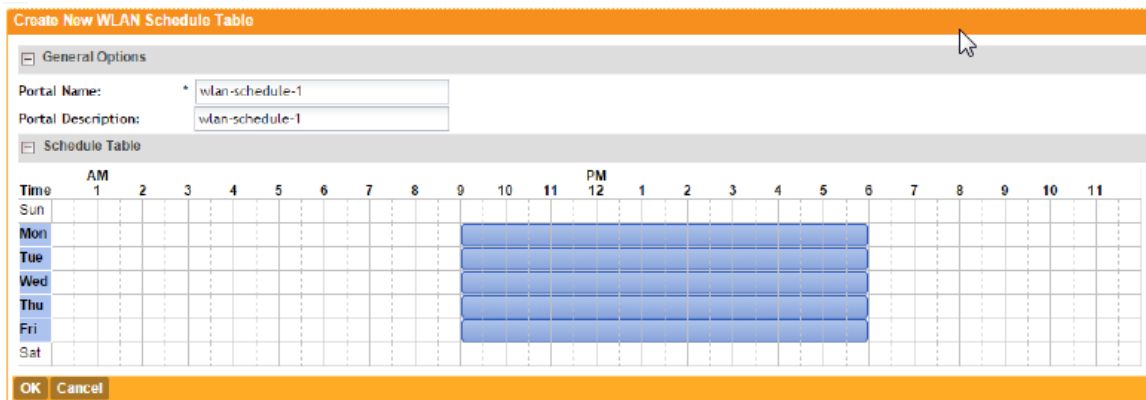


Figure 27: Creating a WLAN schedule

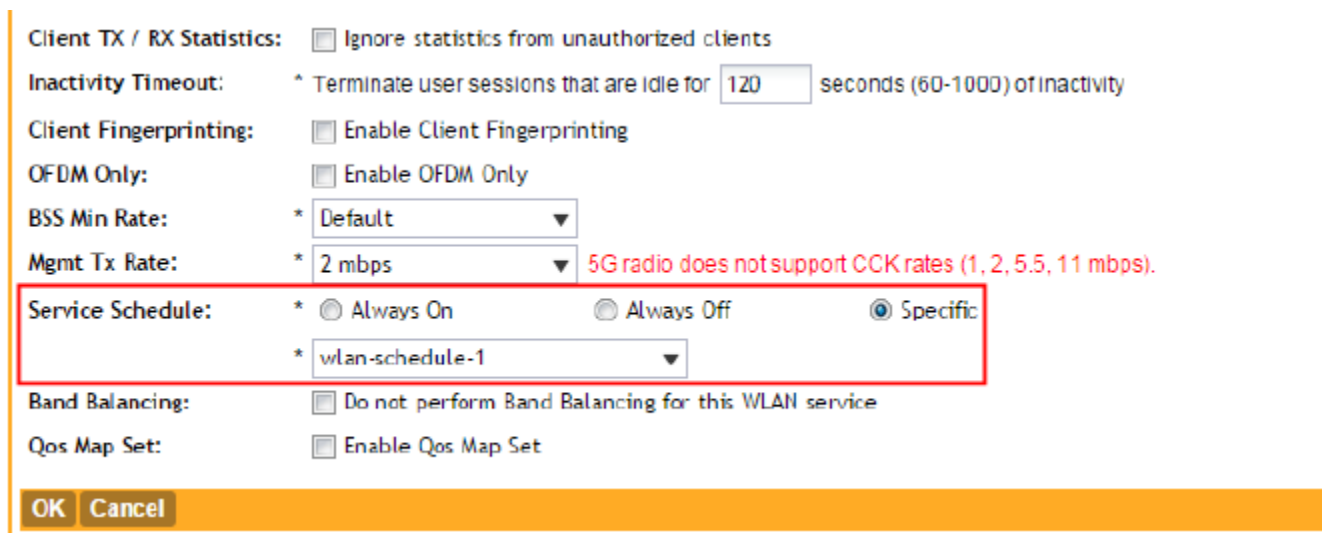


Figure 28: The WLAN schedule appears as an option when you set the WLAN service schedule to "Specific"

## Working with Device Policies

In response to the growing numbers of personally owned mobile devices such as smart phones and tablets being brought into the network, IT departments are requiring more sophisticated control over how devices connect, what types of devices can connect, and what they are allowed to do once connected. Using device access policies, the system can identify the type of client attempting to connect, and perform control actions such as permit/deny, rate limiting, and VLAN tagging based on the device type. Once a device access policy has been created, you can apply

the policy to any WLANs or WLAN groups for which you want to control access by device type. You could, for example, allow only Apple OS devices on one WLAN and only Linux devices on another.

## Creating a Device Access Policy

Using device access policies, the system can identify the type of client attempting to connect, and perform control actions.

Follow these steps to create a device access policy.

1. Go to Configuration>AP Zones.
2. Click the AP zone for which you want to create a device access policy.
3. On the AP Zones submenu, click Device Policy.
4. Click Create New.
5. In Name, type a name for this policy.
6. In Description, type a short description for this policy.
7. In Default Access, click either Allow or Block. This is the default action that the system will take if no rules are matched.
8. In the **Rules** section, click Create New.

The **Create New Device Policy Rules** form appears.

9. Configure the rule settings:
  - Description: Type a description for this rule.
  - Action: Select either Allow or Block. This is the action that the system will take if the client matches any of the attributes in the rule.
  - Device Type: Select from any of the supported client types.
  - Rate Limiting:
    - Uplink: Select the **Enable** check box and define the uplink rate limit for this client type.
    - Downlink: Select the **Enable** check box and define the downlink rate limit for this client type.
  - VLAN: Segment this client type into a specified VLAN (1~4094; if no value is entered, this policy does not impact device VLAN assignment).
10. To add a new rule, click Create New again, and then repeat [Step 9](#).
11. When you finish creating all the rules that you want to add to the policy, click OK at the bottom of the form.

The page refreshes, and then the policy that you created appears under the **Device Policy Services** section.

You have completed creating a device access policy.

Figure 29: The Create New Device Policy Service form

## Viewing Device Access Policies

Device access policies help in identifying the type of client attempting to connect, and perform control actions such as permit/deny, rate limiting, and VLAN tagging based on the device type. Once a device access policy has been created, you can apply the policy to any WLANs or WLAN groups for which you want to control access by device type.

Follow these steps to view a list of existing device access policies.

1. Go to Configuration>AP Zones.
2. Click the AP zone for which you want to view existing device access policies.
3. On the AP Zones submenu, click Device Policy.

The **Device Policy Services** page appears and lists all existing device access policies and their basic settings are shown, including the:

- Name
- Description
- Default access (allow or block)
- Actions (that you can perform)

4. To view or update policy settings, click the policy name.  
You have completed viewing device access policies.

## Deleting Device Access Policies

Follow these steps to delete device access policies.

1. Go to Configuration>AP Zones.
2. Click the AP zone for which you want to create a device access policy.
3. On the AP Zones submenu, click Device Policy.
4. Locate the policy or policies that you want to delete.
5. Select the check boxes (first column) for the policies that you want to delete.
6. Click Delete Selected.

The policies that you selected disappear from the list. You have completed deleting device access policies.

**NOTE:** If you are deleting a single policy, you can also click the icon (under the Actions column) that is in the same row as the policy that you want to delete.

## Working with L2 Access Control Policies

Another method to control access to the network is by defining Layer 2/MAC address access control lists (ACLs), which can then be applied to one or more WLANs or WLAN groups.

L2 ACLs are either allow-only or deny-only; that is, an ACL can be set up to allow only specified clients or to deny only specified clients. MAC addresses that are in the deny list are blocked at the AP.

### Creating an L2 Access Policy

To control access to the network, define the Layer 2/MAC address access control lists (ACLs), which can then be applied to one or more WLANs or WLAN groups.

Follow these steps to create an L2 access policy.

1. Go to Configuration>AP Zones.
2. Click the AP zone for which you want to create an L2 ACL.
3. On the AP Zones submenu, click L2 Access Control.
4. Click Create New.

The **Create New L2 Access Control Service** form appears.

5. In Name, type a name for this policy.
6. In Description, type a short description for this policy.
7. In Restriction, select the default action that the controller will take if no rules are matched. Available options include:
  - **Only allow all stations listed below**
  - **Only block all stations listed below**
8. In MAC Address (under the **Rules** section), type the MAC address to which this L2 access policy applies.
9. Click Add.
10. To add another MAC address, repeat steps 8 to 9.
11. When you have finished adding all the MAC addresses that you need to add, click OK.

The page refreshes, and then the L2 access policy that you created appears in the **L2 Access Control Services** section.

You have completed creating an L2 access policy.

The screenshot shows a web-based configuration form titled "Create New L2 Access Control Service". It has an orange header bar. The form is organized into sections: "General Options" and "Rules". In the "General Options" section, there are input fields for "Name" and "Description", and radio buttons for "Restriction" (selected: "Allow only the stations listed below", unselected: "Block only the stations listed below"). The "Rules" section contains a "MAC Address" input field with "Add", "Import CSV", "Cancel", and "Delete" buttons. Below this is a table with a header "MAC Address" and an empty row. At the bottom of the form are "OK" and "Cancel" buttons.

Figure 30: The Create New L2 Access Control Services form

## Viewing L2 Access Policies

To control access to the network, define Layer 2/MAC address access control lists (ACLs), which can be applied to one or more WLANs or WLAN groups. L2 ACLs are either allow-only or deny-only; that is, an ACL can be set up to allow only specified clients or to deny only specified clients. MAC addresses that are in the deny list are blocked at the AP.

Follow these steps to view a list of existing L2 access profiles.

1. Go to Configuration>AP Zones.
2. Click the AP zone for which you want to view existing L2 ACLs.
3. On the AP Zones submenu, click L2 Access Control.
4. Look for the **L2 Access Control Services** section.

All existing L2 access policies and their basic settings are shown, including the:

- Name
  - Description
  - Default access (allow or block)
  - Actions (that you can perform)
5. To view or change the MAC addresses have been defined in a particular L2 access policy, click the profile name.

You have completed viewing existing L2 access policies.

## Deleting L2 Access Policies

Follow these steps to delete L2 access policies.

1. Go to Configuration>AP Zones.
2. Click the AP zone from which you want to delete L2 ACLs.
3. On the AP Zones submenu, click L2 Access Control.
4. In the **L2 Access Control Services** section, locate the policy or policies that you want to delete.
5. Select the check boxes (first column) for the policies that you want to delete.
6. Click Delete Selected.



The policies that you selected disappear from the list. You have completed deleting L2 access policies.

**NOTE:** If you are deleting a single policy, you can also click the icon (under the **Actions** column) that is in the same row as the policy that you want to delete.

## Working with Bonjour Policies

Bonjour<sup>®</sup> is Apple's implementation of a zero-configuration networking protocol for Apple<sup>®</sup> devices over IP. It allows OS X<sup>®</sup> and iOS devices to locate other devices such as printers, file servers and other clients on the same broadcast domain and use the services offered without any network configuration required.

Multicast applications such as Bonjour<sup>®</sup> require special consideration when being deployed over wireless networks. Bonjour<sup>®</sup> only works within a single broadcast domain, which is usually a small area. This is by design to prevent flooding a large network with multicast traffic. However, in some situations, a user may want to offer Bonjour<sup>®</sup> services from one VLAN to another.

The controller's Bonjour<sup>®</sup> gateway feature addresses this requirement by providing an mDNS proxy service configurable from the web interface to allow administrators to specify which types of Bonjour<sup>®</sup> services can be accessed from/to which VLANs.

In order for the Bonjour<sup>®</sup> Gateway to function, the following network configuration requirements must be met:

1. The target networks must be segmented into VLANs.
2. VLANs must be mapped to different SSIDs.
3. The controller must be connected to a VLAN trunk port.

Additionally, if the VLANs to be bridged by the gateway are on separate subnets, the network has to be configured to route traffic between them.

### Creating a Bonjour Gateway Rule on the AP

Using the Bonjour<sup>®</sup> gateway feature, Bonjour<sup>®</sup> bridging service is performed on a designated AP rather than on the controller. Offloading the Bonjour<sup>®</sup> policy to an AP is necessary if a Layer 3 switch or router exists between the controller and the APs.

The controller identifies a single AP that meets the memory/processor requirements (this feature is only supported on certain APs), and delivers a set of service rules - a Bonjour policy - to the AP to perform the VLAN bridging.

**NOTE:** This feature is only supported on the following access points: R300, R310, R500, R600, R700, R710, T300, T710, 7982, 7372/52, 7055, 7782/81 and SC-8800 series.

Here are the requirements and limitations of the Bonjour gateway feature:

- Bonjour<sup>®</sup> policy deployment to an AP takes effect after the AP joins the controller.
- Some APs of one local area link must be on one subnet. The switch interfaces connected to these APs in a local area link to must be configured in VLAN-trunk mode. Only by doing so

can the designated AP can receive all the multicast Bonjour protocol packets from other VLANs.

- Dynamic VLANs are not supported.
- Some AP models are incompatible with this feature due to memory requirements.

Follow these steps to create rules for an AP that will bridge Bonjour<sup>®</sup> services across VLANs.

1. Go to **Configuration > AP Zones**.
2. On the **AP Zone List** page, click the zone name for which you want to configure the Bonjour<sup>®</sup> gateway.
3. On the **AP Zones** sidebar, click **Bonjour Policy**.
4. Click **Create New** to create a Bonjour gateway policy.  
The **Create Bonjour Policy** form appears.
5. In **Name**, type a name for the policy.
6. In **Description**, type a description for the policy.
7. In the **Rules** section, click **Create New** to create a rule.
8. Configure the following options:
  - Bridge Service: Select the Bonjour<sup>®</sup> service from the list.
  - From VLAN: Select the VLAN from which the Bonjour<sup>®</sup> service will be advertised.
  - To VLAN: Select the VLAN to which the service should be made available.
  - Notes: Add optional notes for this rule.
9. Click **Save** to save the rule.
10. To create another rule, repeat steps 7 on page 90 to 9 on page 90.
11. After you finish creating all rules that you require, click **OK** to close the **Create Bonjour Policy** form.
12. Select the **Enable Bonjour gateway on the AP** check box.

You have completed creating a Bonjour<sup>®</sup> gateway policy.

**Create New Guest Access Portal**

**General Options**

Portal Name: \*

Portal Description:

Language: \* English ▼

**Redirection**

Start Page: After user is authenticated,

Redirect to the URL that user intends to visit.

Redirect to the following URL:

\*

**Guest Access**

Guest Pass SMS Gateway: \* Disabled ▼

Terms and Conditions:  Show Terms and Conditions

Terms of Use

By accepting this agreement and accessing the wireless network, you acknowledge that you are of legal age, you have read and understood, and agree to be bound by this agreement.  
(\* ) The wireless network service is provided by the property owners and is completely at their discretion. Your access to the network may be blocked, suspended, or terminated at any time for any reason.  
(\* ) You agree not to use the wireless network for any purpose that is unlawful or otherwise prohibited and you are fully responsible for your use.

Web Portal Logo: Upload your logo to display it on the web portal pages. The recommended image size is 138 x 40 pixels and Select an image file to

Figure 31: The Create Bonjour Policy form

### Applying a Bonjour Policy to an AP

Once you have created a Bonjour<sup>®</sup> policy for an AP, you will need to designate the AP that will be responsible for implementing this policy.

Follow these steps to apply a Bonjour<sup>®</sup> policy to an AP.

1. Go to **Configuration > Access Points**.
2. From the list of APs, click the MAC address of the AP to which you want to apply the Bonjour policy. The **Edit AP [MAC address]** form appears.
3. Scroll down to the **Advanced Options** section, and then locate the Bonjour Gateway option.
4. Select the **Enable as Bonjour gateway with policy** check box, and then select the Bonjour<sup>®</sup> policy that you want to apply to the AP.
5. Click **Apply**.

You have completed applying a Bonjour<sup>®</sup> gateway policy to an AP.

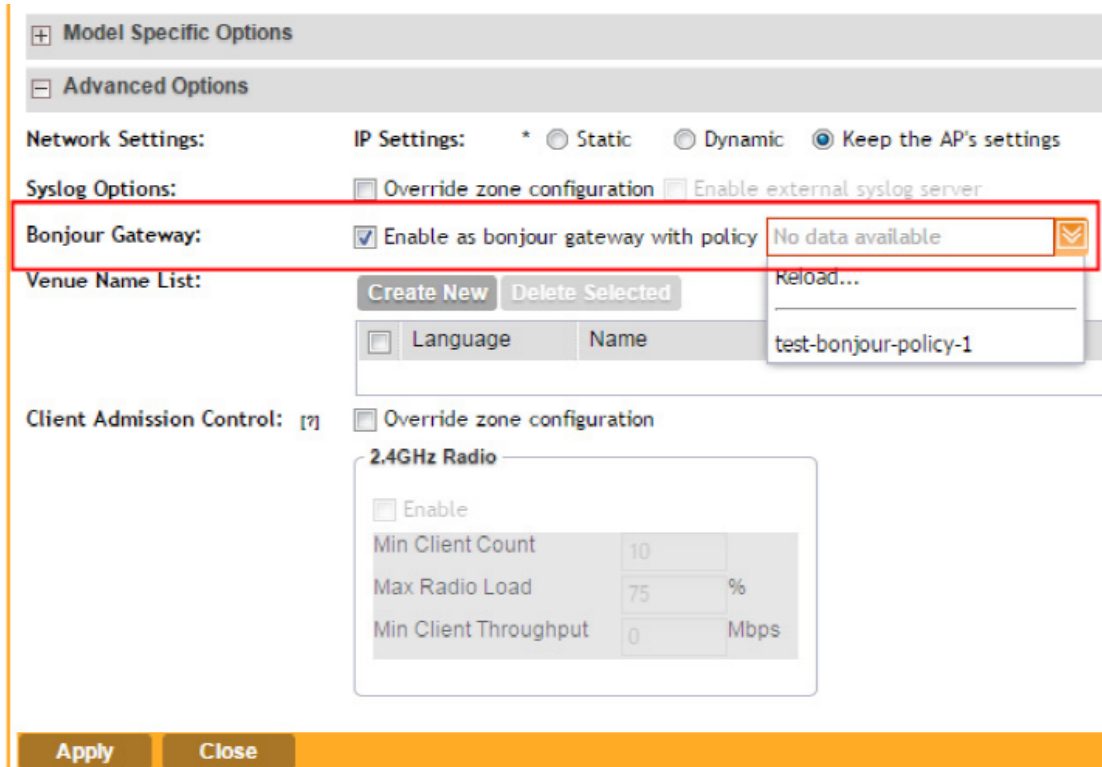


Figure 32: Select the Bonjour<sup>®</sup> policy that you created earlier

## Creating a DiffServ Profile

If you need to configure the type of traffic (ToS) bit settings for the access side traffic from Ruckus Wireless APs, follow these steps to create a Differentiated Services (DiffServ) profile.

This profile can only be applied to Ruckus GRE and SoftGRE traffic. Follow the steps to create a diffserv profile.

1. Click AP Zones > Zone Name ({AP Zone Name}) > DiffServ.

For example, if you want to create a DiffServ profile for an AP zone named “ap-zone-1,” click AP Zones > Zone Name (ap-zone-1) > DiffServ.

The **DiffServ Profiles** page appears.

2. Click Create New.

The form for creating a new DiffServ profile appears.

3. In Name, type a name for the DiffServ profile that you are creating.
4. In Description, type a brief description for the DiffServ profile.
5. In Tunnel DiffServ, configure the following options.

- Set Uplink DiffServ: Select the check box if you want to set the Differentiated Services field for uplink user traffic from Ruckus Wireless APs towards either the controller or a third

party gateway via SoftGRE. Configure the desired value to be set by the Ruckus Wireless AP.

- Set Downlink DiffServ: Select the check box if you want to set the Differentiated Services field for downlink user traffic from the controller towards the AP, and then configure the desired value to be set by the Ruckus Wireless AP.
6. In Preserved DiffServ, configure up to eight (8) entries in the preserved DiffServ list. The Preserved DiffServ list allows the preservation of values that have been already marked in incoming packets either in uplink or downlink traffic.
  7. Click OK.

The page refreshes, and then the DiffServ profile you created appears on the page.

You have completed creating a DiffServ profile.

**NOTE:** Control DSCP can be configured from the controller's CLI.

DiffServ Profiles

Refresh Create New Delete Selected Search terms:  x  Include all terms  Include any of these terms

Name	Description
------	-------------

**Create Tunnel DiffServ Profile**

Name: \*

Description:

Tunnel DiffServ:

Set Uplink DiffServ 0x

Set Downlink DiffServ 0x  Downlink DiffServ only applies to RuckusGRE tunnel

Preserved DiffServ: 0x   Up to 8 preserved DiffServ allowed

Figure 33: The Create Tunnel DiffServ Profile form

## Creating an Ethernet Port Profile

An Ethernet port profile contains settings that define how an AP will handle VLAN packets when its port is designated as either trunk, access, or general port. By default, two Ethernet port profiles exist: **Default Access Port** and **Default Trunk Port**.

Follow the steps to create an Ethernet port profile.

1. On the menu, click **Configuration > AP Zones**.
2. On the sidebar, click **Ethernet Port**.  
The **Ethernet Port Profiles** page appears.
3. Click **Create New**.  
The **Create New Ethernet Port** form appears.
4. Configure the options that appear in the form.

Option	Description
<b>General Options</b>	
<b>Name</b>	Type a name for the Ethernet port profile that you are creating.
<b>Type</b>	<p>The Ethernet port type defines how the AP will manage VLAN frames. You can set Ethernet ports on an AP to one of the following types:</p> <ul style="list-style-type: none"><li>• Trunk Port</li><li>• Access Port</li><li>• General Port</li></ul> <p>For more information about Ethernet port types, see <a href="#">Designating an Ethernet Port Type</a> on page 52.</p>
<b>Port Setting</b>	
<b>Tunnel</b>	<p>Select this check box to enable tunneling on the Ethernet port.</p> <p><b>NOTE:</b> This check box only appears when <b>Type</b> is set to <b>Access</b>.</p>
<b>VLAN Untag ID</b>	Type the ID of the native VLAN (typically, 1), which is the VLAN into which untagged ingress packets are placed upon arrival. If your network uses a different VLAN as the native VLAN, configure the AP Trunk port's VLAN Untag ID with the native VLAN used throughout your network.
<b>VLAN Members</b>	Type the VLAN IDs that you want to use to tag WLAN traffic that will use this profile. You can type a single VLAN ID or a VLAN ID range (or a combination of both). The valid VLAN ID range is 1 to 4094.
<b>Enable Dynamic VLAN</b>	<p>Select this check box if you want the controller to assign VLAN IDs on a per-user basis. Before enabling dynamic VLAN, you need to define on the RADIUS server the VLAN IDs that you want to assign to users.</p> <p><b>NOTE:</b> This option is only available when <b>Type</b> is set to <b>Access Port</b> and <b>802.1X</b> authentication is set to <b>MAC-based Authenticator</b>.</p>
<b>Guest VLAN</b>	<p>If you want to assign a device that fails authentication to still be able to access the Internet but to internal network resources, select this check box.</p> <p><b>NOTE:</b> This check box only appear when the <b>Enable Dynamic VLAN</b> check box is selected.</p>
<b>802.1X</b>	<p>This option, which is disabled by default, controls the type of 802.1X authenticator that you want to use to authenticate devices. Available options include:</p> <ul style="list-style-type: none"><li>• <b>MAC-based Authenticator:</b> If you select this authenticator, each MAC address host is individually authenticated. Each newly-learned MAC address triggers an EAPOL request-identify frame.</li></ul>

Option	Description
	<ul style="list-style-type: none"><li>• <b>Port-based Authenticator:</b> If you select this authenticator, only a single MAC host must be authenticated for all hosts to be granted access to the network.</li></ul>
<b>Authenticator</b>	This section only appears when 802.1X is set to either <b>MAC-based Authenticator</b> or <b>Port-based Authenticator</b> .
<b>Authentication Server</b>	Select the authentication server to use. If you want to use the controller as proxy, select the <b>Use the Controller as Proxy</b> check box instead.
<b>Accounting Server</b>	Select the accounting server to use. If you want to use the controller as proxy, select the <b>Use the Controller as Proxy</b> check box instead.
<b>Enable MAC authentication bypass</b>	Select this check box to allow AAA server queries using the MAC address as both the user name and password. If MAC authentication is unsuccessful, the normal 802.1X authentication exchange will be attempted.

5. Click **OK**.

The page refreshes, and then the profile you created appears on the list of Ethernet port profiles. You can now use this profile to configure the port settings of specific AP models. See [Configuring Model Based Settings](#) on page 48.

## Ethernet Port

### Ethernet Port Profiles

View all Ethernet Port Profiles that can be used by AP Group, Zone and AP, or create a new one.

Refresh Create New Delete Selected Search terms:  x Includ

Name ▲	Description	Type
<b>Create New Ethernet Port</b>		
[-] General Options		
Name:	*	<input type="text"/>
Description:		<input type="text"/>
Type:	*	Trunk Port ▼
[-] Port Setting		
VLAN Untag ID:	*	<input type="text" value="1"/>
VLAN Members:	*	<input type="text" value="1-4094"/>
Enable Dynamic VLAN:		<input type="checkbox"/>
Guest VLAN:	*	<input type="text"/>
802.1X:	*	Disabled ▼
OK Cancel		

Figure 34: Options for creating an Ethernet port profile

### Important Notes About Ethernet Port Profiles

If you are using Ethernet port profiles to handle VLAN traffic to and from managed APs, take note of these important notes and caveats.

- Dynamic VLANs and guest VLANs only support the access port and MAC-based authenticator.
- Tunnels only support the access port.
- 802.1x options are only supported when the AP's mesh mode is **Root**, **Mesh**, or **Disable**.
- At least one trunk port must be enabled on the AP for the Ethernet port profile to work.
- The AP can only have a supplicant port.



## Working With Dynamic PSKs

Dynamic PSKs (DPSKs) are unique per-shared keys assigned to a user or device to provide secure wireless access, avoiding manual configuration and managing encryption keys.

DPSK is a form of PSK (static key) in a WPA2 WLAN and its purpose is to provide each Users Device (UD) with a unique Dynamic PSK to associate to a WLAN without any modifications to the WLAN configuration.e.g. a school administrator provides a time-limited DPSK for a students UD so that the student can access the schools WLAN for the period their DPSK is valid. After the validity period ends, the DPSK expires and the students UD can no longer access the schools WLAN. Without the use of DPSKs the school administrator would have to change the default static key to prevent the student from using the WLAN resources which would in turn impact all other users of that WLAN.

Individual DPSK can be deleted in the event of a student leaving the school, or their device being lost/stolen without impacting other users of the WLAN.

A “bound” DPSK is one which is assigned to the MAC address of a UD at the time of creation. No other UD can utilise this DSPK.e.g. an administrator creates a DPSK entry “acegkmp” specifically for the UD MAC address 00:11:22:33:55:66.

An “unbound” DPSK is not assigned to a UD MAC during creation, but upon first use i.e. when the UD is connected to the secure WLAN and the DPSK is entered as the WLAN security key. Once a DPSK becomes assigned to a UD it becomes bound and no other UD can utilise it.e.g. an administrator creates one unbound DPSK entry “zrxvnbdfh”; the UD with a MAC address of AA:BB:CC:DD:EE:FF uses this DPSK and it becomes bound to that UD.

The DPSK feature can be enabled on WPA2 Encrypted WLANs and the DPSK type (very secure or keyboard-friendly), key length and validity period can then be specified. Once enabled on a WLAN the administrator can auto-generate up to 100 unbound DPSK entries at a time through the UI, or generate bound/unbound DPSK by importing a CSV file. To view the generated DPSK for distribution the administrator must select the “Export CSV” UI option. The resultant CSV file contains the generated DPSK and the respective UD MAC for bound DPSK. The administrator then distributes the bound/unbound DPSK as required.

This section describes the following tasks:

### Viewing Dynamic PSKs

Follow these steps to view the dynamic PSKs:

Click **Configuration > Identity > Dynamic PSK Configuration > AP Zone > AP Zone List > {Zone Name} > Dynamic PSK.**

The **Dynamic PSK** page appears listing the PSKs that were generated.

The following information about dynamic PSKs are available:

- User Name
- MAC Address
- WLAN (SSID)
- VLAN ID
- Created Date

- Expiration Date
- Expired
- Actions

You can sort the list of DPSKs as well.

You can also export the DPSKs listed to a CSV file up to a maximum up to 250 entries.

The **Delete Expired DPSKs** option available on the **Dynamic PSKs** page allows you to customize when the system must remove the DPSKs that are no longer valid. Following are the settings available:

- **Never:** No action must be taken for the expired DPSKs.
- **After 1 day:** Auto delete DPSKs that have expired after one day.
- **After 6 months:** Auto delete DPSKs that have expired after 6 months.

You have completed viewing the list of dynamic PSKs.

## Generating Dynamic PSKs

You can generate new dynamic PSKs to secure the WiFi network.

Follow these steps to generate the dynamic PSKs (DPSKs):

1. Click **Configuration > Identity > Dynamic PSK Configuration > AP Zone > AP Zone List > {Zone Name} > Dynamic PSK**.

The **Dynamic PSK** page appears listing the PSKs that were generated.

2. Click **Generate DPSKs**.

The **Generate DPSKs** dialog box appears. Provide the following information:

- **WLAN:** select a WLAN (DPSK-enabled) from the drop-down list
- **Number of DPSKs:** Type the number of PSKs you want to create. A maximum of 100 entries are possible at a time.

For SCG200 or vSZ-H, a maximum of 10000 DPSKs can be included within an AP zone, and a maximum of 20000 DPSKs can be included within a cluster. For SZ100 or vSZ-E, a maximum of 10000 DPSKs can be included. For both SCG200 and SZ100 (an their virtual platforms), 256 unbound DPSKs (DPSKs that are not bundled with a MAC address) can be included within an AP zone.

- **VLAN ID:** Type the VLAN ID within the range 1-4094

3. Click **Generate**.

To delete a DPSK, select the check-box and click the  icon.

You have completed creating the dynamic PSK.

## Importing Dynamic PSKs

You can import CSV files to create DPSKs to secure the WiFi network.

Follow these steps to import dynamic PSKs (DPSKs):

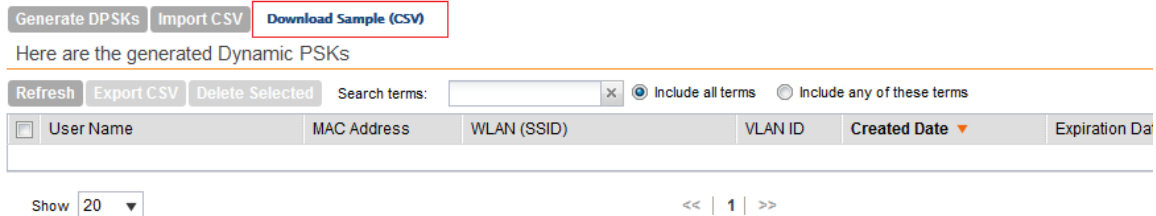
1. Click **Configuration > Identity > Dynamic PSK Configuration > AP Zone > AP Zone List > {Zone Name} > Dynamic PSK.**

The **Dynamic PSK** page appears listing the DPSKs that were generated.

2. Click the **Download Sample (CSV)** link to download the CSV file template.

AP Zone: joe-zone >> Dynamic PSK

Dynamic PSKs (DPSKs) are unique PSKs per user/device. Use this menu to create or import new DPSKs or view existing DPSKs on the system.



**Figure 35: Download Sample CSV link**

A sample CSV file is displayed as show in the figure.

#User Name (*)	Mac Address	Vlan ID
DPSK-User-1	00:11:22:33:44:44	
DPSK-User-2	00:11:22:33:44:55	1
DPSK-User-3	11:22:33:44:55:66	2

**Figure 36: Sample CSV file**

Modify the CSV file as appropriate and save it. Following are the components of the CSV file.

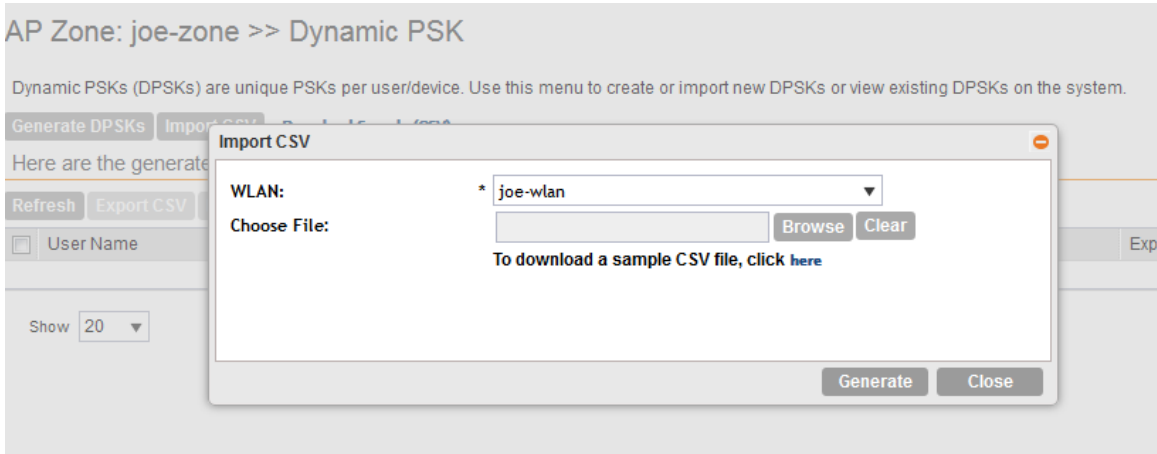
- User Name: Type the name of the user
- MAC Address: Enter the MAC address to generate a DPSK that limits the reach of the network (bound DPSK). If MAC Address field is empty, the DPSK generated in unbound, and has a farther reach within the network.
- VLAN ID: Enter a value to override the WLAN VLAN ID, or leave it empty if you do not want to override the WLAN VLAN ID.

3. Click **Import CSV.**

The **Import CSV** dialog box appears.

**NOTE:** Importing a CSV file to a WLAN containing the same UeMac value as the existing DPSKs in the WLAN, replaces the old DPSKs within the data base.

**Figure 37: Importing a CSV file**



4. In **WLAN**, select a WLAN from the drop-down list. Only WLANs that support DPSK must be selected.
5. In **Choose File**, click **Browse** to choose the CSV file.  
Click **Clear** if you want to replace the CSV file.
6. Click **Generate**.  
The new DPSKs are generated as shown in the figure.

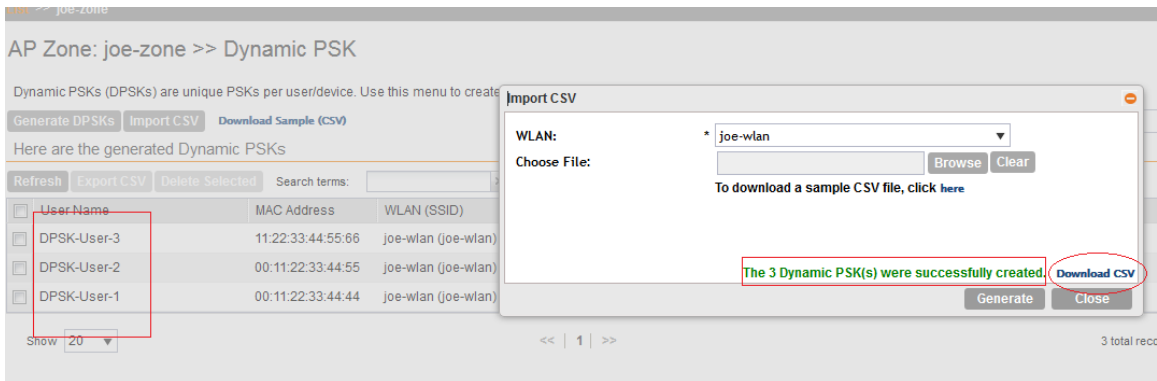


Figure 38: New DPSKs generated

7. Click **Download CSV** to download the DPSKs soon after the DPSKs are generated.  
The CSV file appears in the following format.

User Name	MAC	WLAN (SSID)	Passphrase	VLAN ID	Created Date	Expiration Date
DPSK-User-1	00:11:22:33:44:44	joe-wlan (joe-wlan)	4#4BSXMe		3/17/2016 18:55	Unlimited
DPSK-User-2	00:11:22:33:44:55	joe-wlan (joe-wlan)	rE<r0[]y	1	3/17/2016 18:55	Unlimited
DPSK-User-3	11:22:33:44:55:66	joe-wlan (joe-wlan)	'q=7vqfE	2	3/17/2016 18:55	Unlimited

Figure 39: New CSV format

# Managing Global Configuration, AP Tunnel Profiles, Templates, and AP Registration Rules

## 3

In this chapter:

- [Managing Global Configuration](#)
- [Creating AP Tunnel Profiles](#)
- [Working with Zone Templates](#)
- [Working with WLAN Templates](#)
- [Working with Registration Rules](#)

## Managing Global Configuration

Global configuration refers to the country code and the port number that is used for tunneling GRE + UDP traffic. These settings are applied across all AP zones and the managed devices that belong to each AP zone.

Different countries have different regulations on the usage of radio channels. To ensure that the controller is using an authorized radio channel, select the correct country code for your location. If you change the country code now, this change will only be applied to new zones and the APs that will be assigned to them. Existing zones and the APs that belong to them will retain the country code that was configured previously.

Follow these steps to set the global configuration.

1. Go to **Configuration > AP Zones**.
2. On the sidebar, click **Global Configuration**.
3. In **Default Country Code for New Zone**, select the correct country code for the geographical location where the managed devices (or APs) are deployed.

Selecting the correct country code will ensure that managed devices use an authorized radio channel.

After you select a new country code, the **Apply** and **Cancel** buttons become active.

4. Click **Apply** to save the country code.
5. In AP GRE Tunnel Options, type the port number that you want the controller to use for tunneling GRE and UDP traffic from managed devices.

The default tunnel port number is 23233.

**NOTE:** Make sure that you open this port number on the network firewall to ensure that a GRE tunnel can be established successfully.

After you type the new tunnel port number, the Apply and Cancel buttons become active.

6. Click **Apply** to save the tunnel port number.

## Global Configuration

Global configuration settings apply to all APs managed by the controller.

**Default Country Code for New Zone**

Different countries have different regulations on the usage of radio channels. To ensure that this zone is using an authorized radio channel, select the correct country code for your location.

Country Code: \*

**DP Listen Port**

The tunnel UDP port is used by all GRE+UDP type tunnels.

Tunnel UDP Port: \*

Figure 40: The AP Zone Global Configuration page

## Creating AP Tunnel Profiles

This section describes the procedures for creating Ruckus GRE, SoftGRE, and IPsec tunnel profiles.

### Creating a Ruckus GRE Tunnel Profile

Creating AP Tunnel Profiles include the procedures for creating Ruckus GRE, SoftGRE, and IPsec tunnel profiles.

Follow these steps to create a Ruckus GRE tunnel profile.

1. Go to **Configuration > AP Zones**.
2. On the sidebar, click **AP Tunnel Profiles > Ruckus GRE**.  
The **Ruckus GRE** page appears.
3. Click **Create New**.  
The **Create Ruckus GRE Profile** form appears.
4. Configure the following options.

Option	Description
<b>Name</b>	Type a name for the profile that you are creating.
<b>Description</b>	Type a short description of the profile.

Option	Description
<b>Ruckus Tunnel Mode</b>	Select a protocol to use for tunneling WLAN traffic back to the controller: <ul style="list-style-type: none"> <li>• <b>GRE + UDP:</b> Select this option to allow APs behind a NAT server to tunnel WLAN traffic back to the controller.</li> <li>• <b>GRE:</b> Select this option to tunnel regular WLAN traffic only.</li> </ul>
<b>Tunnel Encryption</b>	Select the <b>Enable tunnel encryption</b> check box if you want managed APs to decrypt 802.11 packets, and then use an AES encrypted tunnel to send them to the controller. By default, when WLAN traffic is tunneled to the controller, only the management traffic is encrypted; data traffic is unencrypted.
<b>WAN Interface MTU</b>	Set the maximum transmission unit (MTU) for the tunnel to either Auto (default) or a specific size (850 to 1500 bytes). MTU is the size of the largest protocol data unit that can be passed on the controller network.

5. Click **Create New**.

You have completed creating a Ruckus GRE tunnel profile.

The screenshot shows a web form titled "Create Ruckus GRE Profile". The form has an orange header and footer. The fields are:
 

- Name:** A text input field with an asterisk indicating it is required.
- Description:** A larger text input field.
- Ruckus Tunnel Mode:** A dropdown menu currently set to "GRE+UDP" with a tooltip that says "Support for APs behind NAT."
- Tunnel Encryption:** A checkbox labeled "Enable tunnel encryption" which is currently unchecked.
- WAN Interface MTU:** A radio button group with "Auto" selected (indicated by a blue dot) and "Manual" unselected. Next to "Manual" is a text input field containing "850" and the label "bytes (850-1500)".

 At the bottom of the form are "OK" and "Cancel" buttons. Below the form, there is a breadcrumb trail: "Default Tunnel Profile" and a user name "admin".

Figure 41: The Ruckus GRE form

### Creating a SoftGRE Tunnel Profile

A SoftGRE tunnel does not support APs that are behind a NAT server.

Follow these steps to create a SoftGRE tunnel profile.

1. Go to **Configuration > AP Zones**.
2. On the sidebar, click **AP Tunnel Profiles > SoftGRE**.

The **SoftGRE** page appears.

3. Click **Create New**.

The **Create SoftGRE Profile** form appears.

4. Configure the following options:

- **Name:** Type a name for the profile that you are creating.
- **Description:** Type a short description of the profile.
- **Gateway IP Mode:** Click the IP addressing mode that the gateway is using. Options include:
  - IPv4
  - IPv6
- **Primary Gateway Address:** Type the IP address or fully-qualified domain name (FQDN) of the primary gateway server.
- **Secondary Gateway Address:** If you have a secondary gateway server on the network, type its IP address or FQDN in the box provided. If the controller is unable to reach the primary gateway server, it will automatically attempt to reach the secondary gateway address that you specify here.
- **Gateway Path MTU:** Set the maximum transmission unit (MTU) for the gateway path. Options include Auto (default) and Manual (range is 850 to 1500 bytes).
- **ICMP Keep Alive Period:** Type the time interval (in seconds) at which APs send a keepalive message to the active third party WLAN gateway. The range is 1 to 180 seconds and the default value is 10 seconds.
- **ICMP Keep Alive Retry:** Type the number of keepalive attempts that APs wait for a response from the active third party WLAN gateway before failing over to the standby WLAN gateway. The range is 2 to 10 retries and the default value is 5 retries.

5. Click **Create New**.

**Create SoftGRE Profile**

**Name:** \*

**Description:**

**Gateway IP Mode:**  IPv4  IPv6

**Primary Gateway Address:** \*

**Secondary Gateway Address:**

**Gateway Path MTU:** \*  Auto  Manual  bytes (850-1500)

**ICMP Keep Alive Period (secs):** \*  (1-180)

**ICMP Keep Alive Retry:** \*  (2-20)

**Force Disassociate Client:**  Disassociate client when AP fails over to another tunnel.

**OK** **Cancel**

Figure 42: Creating a SoftGRE profile

## Creating an IPsec Profile

AP tunnel profiles configuration includes the procedures for IPsec tunnel profiles.

1. Go to **Configuration > AP Zones > AP Tunnel Profiles**.



2. On the sidebar, click **IPSec**.

The **IPsec** page appears.

3. Click **Create New**.

The **Create IPSec Profile** form appears.

4. In **General Options**, configure the following:

- **Name:** Type name for the IPSec profile that you are creating.
- **Description:** Type a description for this profile.
- **Security Gateway:** Type the IP address or FQDN of the IPSec server. If you use the IP address, the IP address format that you must enter will depend on the IP mode that is configured on the controller.

5. In **Authentication**, configure the following:

- **Type:** Click **Preshared Key** to use PSK for authentication or click **Certificate** to use an X.509 certificate on the certificate authority (CA) or registration authority (RA) server. The controller uses the CMPv2 protocol to obtain the signed certificate from the CA/RA server.
- **Preshared Key:** If you clicked **Preshared Key** in **Type**, type the PSK in this box. The PSK must be eight to 128 ASCII characters in length.

6. In **Security Association**, configure the following:

- **IKE Proposal Type:** Click **Default** to use the default Internet Key Exchange (IKE) security association (SA) proposal type or click **Specific** to manually configure the IKE SA proposal. If you clicked **Specific**, you will need to configure the following settings:
  - **Encryption Algorithm:** Options include 3DES, AES128, AES192, and AES256.
  - **Integrity Algorithm:** Options include MD5, SHA1, AES-XCBC, SHA256, SHA384, and SHA512.
  - **Pseudo-Random Function:** Options include Use integrity ALG, PRF-MD5, PRF-SHA1, PRF-AES-XCBC, PRF-AES-CMAC, PRF-SHA256, and PRF-SHA384.
  - **DH Group:** Options for Diffie-Hellman groups for IKE include modp768, modp1024, modp1536, modp2048, modp3072, modp4096, modp6144, and modp8192.
- **ESP Proposal Type:** Click **Default** to use the default Encapsulating Security Payload (ESP) SA proposal type or click **Specific** to manually configure the ESP proposal. If you clicked **Specific**, you will need to configure the following settings:
  - **Encryption Algorithm:** Options include 3DES, AES128, AES192, AES256, and NONE.
  - **Integrity Algorithm:** Options include MD5, SHA1, AES-XCBC, SHA256, SHA384, and SHA512
  - **DH Group:** Options for Diffie-Hellman groups for ESP include None, modp768, modp1024, modp1536, modp2048, modp3072, modp4096, modp6144, and modp8192.

7. In **Rekey Options**, configure the following:

- **Internet Key Exchange:** To set time interval at which the IKE key renews, select a time unit (day, hour, or minute) from the drop-down list, and then type a number in the box. To disable IKE rekey, select the **Disable** check box.
- **Encapsulating Security Payload:** To set time interval at which the ESP key renews, select a time unit (day, hour, or minute) from the drop-down list, and then type a number in the box. To disable ESP rekey, select the **Disable** check box.

8. In **Certificate Management Protocol**, configure the following:

- **DHCP Option 43 Sub Code for CA/RA Address:** Set the DHCP Option 43 subcode that will be used to discover the address of the CA/RA server on the network. The default subcode is 8.
- **CA/RA Address:** Type the IP address or FQDN of the CA/RA server. If you use the IP address, the IP address format that you must enter will depend on the IP mode that is configured on the controller.
- **Server Path:** Type the path to the X.509 certificate on the CA/RA server.
- **DHCP Option 43 Sub Code for Subject Name of CA/RA:** Set the DHCP Option 43 subcode that will be used to discover the subject name of the CA/RA server on the network. The default subcode is 5.
- **Subject Name of CA/RA:** Type an ASCII string that represents the subject name of the CA/RA server.

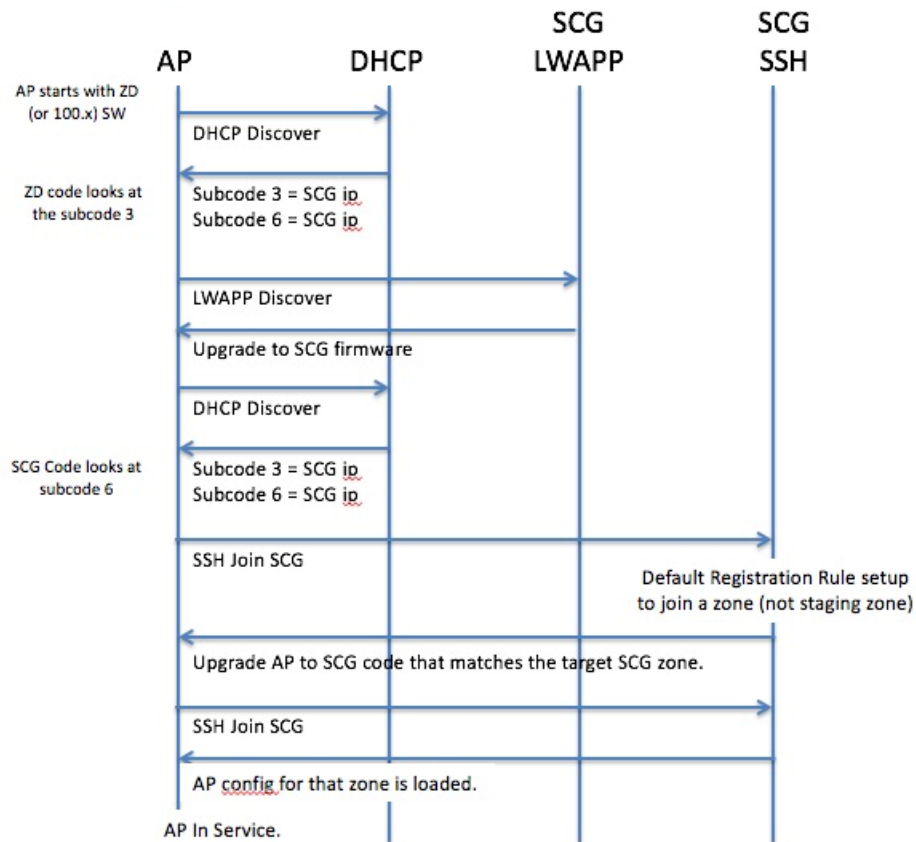


Figure 43: AP discovery with DHCP Option 43 Sub Codes

9. In **Advanced Options**, configure the following:

- **DHCP Option 43 Sub Code for Security Gateway:** Set the DHCP Option 43 subcode that will be used to discover the address of the security gateway on the network. The default subcode is 7.
- **Retry Limit:** Set the number of times that the controller will attempt to discover the address of the security gateway. The default retry count is 5. Accepted values are 0 (disable) to 16.
- **Replay Window:** Set the ESP replay window (in packets). The default size is 32 packets. Accepted values are 0 (disable) to 32 packets.
- **IP Compression:** To enable IP Payload Compression Protocol (IPComp) compression before encryption, click **Enable**. The default value is **Disable**.
- **Force NAT-T:** To enforce UDP encapsulation of ESP packets, click **Enable**. The default value is **Disable**.
- **Dead Peer Detection:** By default, the IKE protocol runs a health check with remote peer to ensure that it is alive. To disable this health check, click **Disable**.
- **NAT-T Keep Alive Interval:** To set the keep alive interval (in seconds) for NAT traversal, type a value in the box. The default keep alive interval is 20 seconds. Accepted values are 1 to 65536. To disable the keep alive interval, click **Disable**.
- **FailOver Options:** To configure the failover settings when APs are unable to connect, configure the following:
  - **Retry Period:** Set the number of days (minimum 3 days) during which APs will keep attempting to connect. To keep try indefinitely, select the **Forever** check box.
  - **Retry Interval:** Set the interval (in minutes) between each retry attempt. The default retry interval is 1 minute. Accepted values are from 1 to 30 minutes.
  - **Retry Mode:** If you want APs to fall back to the specified primary security gateway, click **Revertive**. If you want APs to maintain connectivity with the security gateway to which they are currently connected, click **Non-revertive**.

10. Click .

Figure 44: Creating an IPsec profile

## Customizing The DHCP Server

**NOTE:** The following procedure describes how to customize a DHCP server running on Microsoft Windows. If your DHCP server is running on a different operating system, the procedure may be different.

### Configuring the DHCP Server for SmartZone-AP Communication

To customize your DHCP server, you need to configure DHCP Option 43 (043 Vendor Specific Info) with the IP address of the SmartZone device on the network. When an AP requests an IP address, the DHCP server will send a list of SmartZone IP addresses to the AP. If there are multiple SmartZone devices on the network, the AP will automatically select a SmartZone device to register with from this list of IP addresses.

[RFC 2132](#) describes DHCP Option 60 and Option 43. DHCP Option 60 is the Vendor Class Identifier (VCI). The VCI is a text string that identifies a vendor/type of a DHCP client. All Ruckus Wireless Access Points are configured to send “Ruckus CPE” as the Vendor Class Identifier in

option 60, and expect SmartZone IP information to be provided in DHCP option 43 (Vendor Specific Info), encapsulated with sub-option code 06 (the sub-option code for SCG in this example).

The RFC describes how vendors can encapsulate vendor-specific sub-option codes (ranging from 0 to 255). Sub-options are embedded in option 43 as TLV (type, length, value) blocks.

Ruckus Wireless Access points support non-TLV format option 43 values with comma separated IP address strings for discovering SmartZones, and also TLV based option 43 encapsulation as specified in RFC 2132.

**Example: for SCG information (sub-option code 06)**

**Type:**

0x06

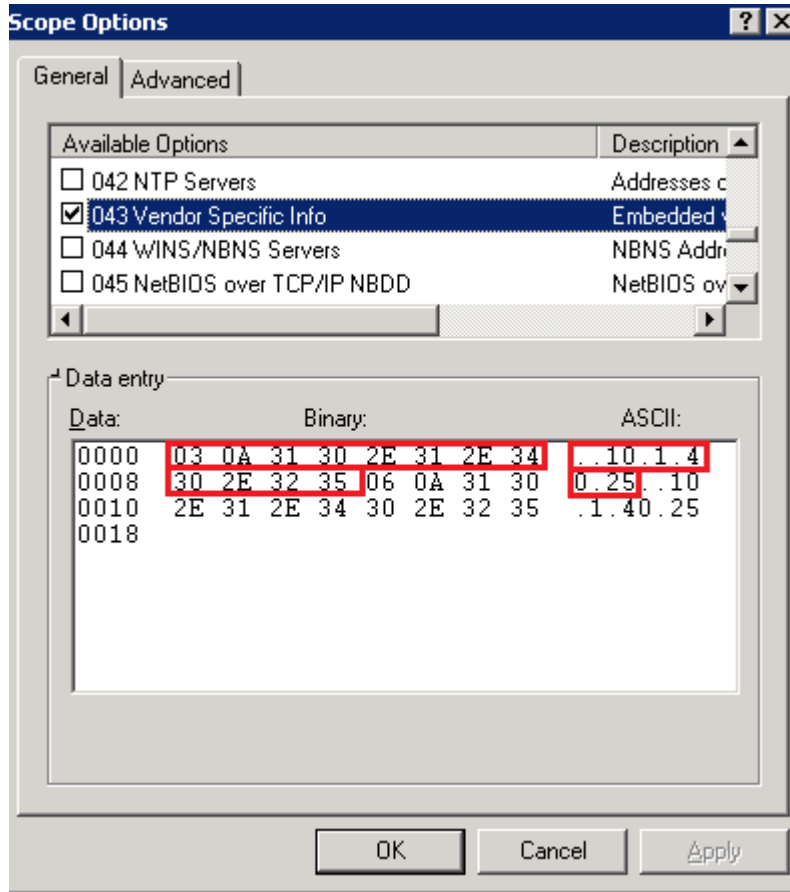
**Length:**

Count of the characters in the ASCII string. (Length must include the commas if there is more than one SCG specified.)

**Value:**

A non-null terminated ASCII string that is a comma-separated list of SCG IP addresses.

For example: If the SCG IP address is 10.1.40.25, then the value will be “ 10.1.40.25 ” and the length is 25 (hex value 0x19).



In the figure, the values within the red box pertain to sub type 03. The TLV for the sub type is the binary value, where **03** is the Type and **0A** is the Length (length is 10). The rest of the values pertain to the server IP address.

The second set of numbers (outside the red box) pertain to sub type 06. The TLV for the sub type is the binary value, where **06** is the Type and **0A** is the Length (length is 10). The rest of the values pertain to the server IP address.

**Figure 45: Sample DHCP43 option in a Windows server**

## Working with Zone Templates

A zone template contains configuration settings (radio, AP GRE tunnel, channel mode, and background scanning) that you can apply to all access points that belong to a particular AP zone. Applying a zone template to an AP zone will overwrite all settings on all access points that belong to that AP zone.

This section describes the following topics:

## Creating and Configuring a Zone Template

Creating a zone template requires that you create the template and configure the services that will be deployed with the template.

Follow these steps to create and configure a zone template.

[Step 1: Create the Zone Template](#)

[Step 2: Configure the AP Model-Specific Configuration](#)

[Step 3: Configure the AAA Servers of the Zone Template](#)

[Step 4: Configure the Hotspot \(WISPr\) Services of the Zone Template](#)

[Step 5: Configure the Hotspot 2.0 Service of the Zone Template](#)

[Step 6: Configure the WLAN Service of the Zone Template](#)

### Step 1: Create the Zone Template

Creating a zone template requires that you create the template and configure the services that will be deployed with the template.

Follow these steps to create a zone template.

1. Click **Configuration** > **AP Zones**.
2. On the sidebar, click **Zone Templates**.

The **Zone Templates** page appears.

3. Click the **Create New** button.

The **Create New Zone Template** form appears.

4. Configure **General Options**.

- a) In **Zone Name**, type a name for the zone that you are creating.
- b) In **Description**, type a description for this template.
- c) In **AP Firmware**, select the AP firmware version to which to apply this template.
- d) In **Country Code**, select the correct code for the country in which you are operating the controller network. Different countries and regions maintain different rules that govern which channels can be used for wireless communications. Selecting the correct country code will ensure that APs that are part of the controller network do not violate local and national regulatory restrictions.
- e) In **AP Admin Logon**, configure the following options:

- **Logon ID**: Set the administrator user name.
- **Password**: Set the administrator password.

Any administrator can use this user name and password combination to log on directly to the managed access point's native web interface.

- f) In **Syslog Options**, if you have a syslog server on the network and you want the controller to send syslog data to it, select the **Enable external server for APs in this zone** check box.

5. Configure **Radio Options**.

- a) In the **Radio Options b/g/n (2.4GHz)** section, configure the following options:
    - **Channelization:** Select the channel width. Options include 20MHz, 40MHz, or 80MHz.
    - **Channel:** Select Auto or manually assign a channel for the 2.4GHz radio.
    - **TX Power Adjustment:** Manually set the transmit power on all 2.4GHz radios (default is Full).
  - b) In **Radio Options a/n (5GHz)**, configure the following options:
    - **Channelization:** Select 20MHz or 40MHz channel width.
    - **Channel:** Select Auto or manually assign a channel for the 5GHz radio.
    - **TX Power Adjustment:** Manually set the transmit power on all 5GHz radios (default is Full).
6. Configure **AP GRE Tunnel Options**.
- a) **Tunnel Type:** Select an option for tunneling WLAN traffic back to the controller:
    - Ruckus GRE
    - SoftGRE
    - SofteGRE + IPsec
  - b) **Tunnel Encryption:** Select the Enable tunnel encryption check box if you want managed APs to decrypt 802.11 packets, and then use an AES-encrypted tunnel to send them to the controller. When WLAN traffic is tunneled to the controller, only the management traffic is encrypted while data traffic is unencrypted by default.
    - **Tunnel MTU Options:** Manually set the maximum transmission unit (MTU) or use Auto (default). MTU is the size of the largest protocol data unit (in bytes) that can be passed on the controller network.
7. Configure the **AP SNMP Options:** select the **Enable AP SNMP** check-box to configure the SNMPv2 and SNMPv3 settings.
8. Configure **Advanced Options**.
- **Channel Mode:** Select the Allow indoor channels check box if you want to allow ZoneFlex outdoor APs to use indoor-use only channels. For more information on channel mode, see [Channel Mode](#) on page 76.
  - **Background Scanning:** If you want APs to automatically evaluate radio channel usage, enable and configure the background scanning settings on both the 2.4GHz and 5GHz radios. By default, background scanning is enabled on both radios and set to run every 20 seconds.
9. Click **Create New** to create the zone template.
10. Continue to [Step 2: Configure the AP Model-Specific Configuration](#).



Figure 46: The Create New Zone Template form

### Step 2: Configure the AP Model-Specific Configuration

Follow these steps to configure the AP model-specific configuration of the zone template.

1. Click **Configuration** > **AP Zones**.
2. On the sidebar, click **Zone Templates**.

The **Zone Templates** page appears.

3. Click the name of the zone template for which you want to configure AP model-specific settings.
4. On the sidebar, click **AP Model-Specific Configuration**.
5. In **Select an AP Model**, select the AP model that you want to configure, and then click **Apply** to display the configuration option for the selected AP model.
6. In **General Options**, configure the following options (depending on the selected AP model, some of the options listed below may not be visible):

- **PoE out port:** To enable the PoE out port on the AP model, select the **Enable the PoE out port** (requires custom PoE injector) check box.
- **Status LEDs:** To disable the external status LEDs on the AP model, select the **Disable status LEDs** check box. This can be useful if your APs are installed in a public location and you do not want to draw attention to them.
- **External Antenna (2.4GHz):** To enable the external 2.4GHz antenna on the AP model, select the **Enable external antenna with [x] dBi (0-90)** check box, and then a value for the dBi.

- **External Antenna (5GHz):** To enable the external 5GHz antenna on the AP model, select the **Enable external antenna with [x] dBi (0-90)** check box, and then a value for the dBi.
- **LLDP:** To enable the AP model to advertise its identity and capabilities on the local network via LLDP, select the **Enable Link Layer Discovery Protocol** check box. For a list of attributes that APs advertise using LLDP, see [Supported LLDP Attributes](#) on page 50.
- **LLDP Advertise Interval (1-300 seconds):** Set the interval (in seconds) at which the AP model will send out LLDP information. The default value is 30 seconds.
- **LLDP Hold Time (60-1200 seconds):** Set the length of time (in seconds) that a receiving device will hold the LLDP information sent by the selected AP model before discarding it. The default value is 120 seconds.
- **LLDP Management IP TLV:** To include the management IP address TLV in the LLDP information that the AP model sends out, select **Enable** check box.
- **Port Settings:** For information on how to configure the port settings, see [Configuring the Port Settings of a Particular AP Model](#) on page 51.

7. Continue to [Step 3: Configure the AAA Servers of the Zone Template](#).

### Step 3: Configure the AAA Servers of the Zone Template

Follow these steps to configure the AAA servers that the zone template will use.

1. Click **Configuration** > **AP Zones**.
2. On the sidebar, click **Zone Templates**.

The **Zone Templates** page appears.

3. Click the name of the zone template for which you want to configure an AAA server.
4. On the sidebar, click **AAA**.
5. Click **Create New**.

The form for creating a new RADIUS server appears.

6. Configure **General Options**.

- **Name:** Type a name for the AAA server that you are adding.
- **Type:** Select the type of AAA server that you have on the network. Options include:
  - RADIUS
  - RADIUS Accounting
  - Active Directory
  - LDAP
- **Backup RADIUS:** Select the **Enable backup RADIUS server** check box if a secondary RADIUS server exists on the network. Configure the settings in [Step 8](#).

7. In the **Primary Server** section, configure the settings of the primary RADIUS server.

- **IP Address:** Type the IP address of the AAA server.
- **Port:** Type the port number of the AAA server. The default RADIUS server port number is 1812 and the default RADIUS Accounting server port number is 1813.
- **Shared Secret:** Type the AAA shared secret.
- **Confirm Secret:** Retype the shared secret to confirm.

8. In the **Secondary Server** section, configure the settings of the secondary RADIUS server.

**NOTE:** The **Secondary Server** section is only visible if you selected the **Enable backup RADIUS server** check box earlier.

- **IP Address:** Type the IP address of the secondary AAA server.
- **Port:** Type the port number of the secondary AAA server port number. The default RADIUS server port number is 1812 and the default RADIUS Accounting server port number is 1813.
- **Shared Secret:** Type the AAA shared secret.
- **Confirm Secret:** Retype the shared secret to confirm.

9. Click **Create New** to create the AAA server for the zone template.

10. Continue to [Step 4: Configure the Hotspot \(WISPr\) Services of the Zone Template](#).

#### **Step 4: Configure the Hotspot (WISPr) Services of the Zone Template**

Settings to configure a hotspot portal in the zone template.

**NOTE:** If you do not need to provide a hotspot portal to users, skip this section.

If you need more information about hotspots, including third party prerequisites, see [Creating and Managing Hotspots](#) on page 267.

Follow these steps to configure the hotspot settings for the zone template.

1. Click **Configuration** > **AP Zones**.
2. On the sidebar, click **Zone Templates**.

The **Zone Templates** page appears.

3. Click the name of the zone template for which you want to configure a hotspot portal.
4. On the sidebar, click **Hotspot (WISPr)**.
5. Click **Create New**.

The form for creating a new hotspot portal appears.

6. In the **General Options** section, configure the following options:

- **Name:** Type a name for the hotspot portal.
- **Description:** Type a description for the hotspot portal.

7. In the **Redirection** section, configure the following options:

- **Smart Client Support:** Select one of the following options:
  - **None:** Select this option to disable Smart Client support on the hotspot portal.
  - **Enable:** Selection this option to enable Smart Client support.
  - **Only Smart Client Allowed:** Select this option to allow only Smart Clients to connect to the hotspot portal.

For more information, see [Configuring Smart Client Support](#) on page 279.

- In **Logon URL**, type the URL of the subscriber portal (the page where hotspot users can log on to access the hotspot portal). For more information, see [Configuring the Hotspot Logon URL](#) on page 279.
  - In **Start Page**, set where users will be redirected after they log in successfully:
    - **Redirect to the URL that user intends to visit:** You could redirect users to the page that they want to visit.
    - **Redirect to the following URL:** You could set a different page where users will be redirected (for example, your company website).
8. In the **User Session** section, configure the following options:
- **Session Timeout:** Set a time limit (in minutes) after which users will be disconnected from the hotspot portal and will be required to log on again.
  - **Grace Period:** Set the time period (in minutes) during which disconnected users are allowed access to the hotspot portal without having to log on again.
9. In the **Location Information** section, configure the following options:
- **Location ID:** Type the ISO and ITU country and area code that the AP includes in accounting and authentication requests. The required code includes:
    - **isocc (ISO-country-code):** The ISO country code that the AP includes in RADIUS authentication and accounting requests.
    - **cc (country-code):** The ITU country code that the AP includes in RADIUS authentication and accounting requests.
    - **ac (area-code):** The ITU area code that the AP includes in RADIUS authentication and accounting requests.
    - network

The following is an example of what the Location ID entry should look like:

```
isocc=us,cc=1,ac=408,network=RuckusWireless
```
  - **Location Name:** Type the name of the location of the hotspot portal.
10. In **Walled Garden**, click **Create New** to add a walled garden.
- A walled garden is a limited environment to which an unauthenticated user is given access for the purpose of setting up an account.
11. In the box provided, type a URL or IP address to which you want to grant unauthenticated users access.
- You can add up to 128 network destinations to the walled garden. Network destinations can be any of the following:
- IP address (for example, 10.11.12.13)
  - Exact website address (for example, www.ruckuswireless.com)
  - Website address with regular expression (for example, \*.ruckuswireless.com, \*.com, \*)

After the account is established, the user is allowed out of the walled garden. URLs will be resolved to IP addresses. Users will not be able to click through to other URLs that may be presented on a page if that page is hosted on a server with a different IP address. Avoid using common URLs that are translated into many IP addresses (such as `www.yahoo.com`), as users may be redirected to re-authenticate when they navigate through the page.

**12** Click **Create New** to create the hotspot portal of the zone template.

**13** Continue to [Step 5: Configure the Hotspot 2.0 Service of the Zone Template](#).

For additional steps that you need to perform to ensure that the WISPr hotspot portal works, see [Creating and Managing Hotspots](#) on page 267.

### Step 5: Configure the Hotspot 2.0 Service of the Zone Template

To configure a Hotspot 2.0 service, you will need to create and configure at least one service provider profile and one operator profile.

Refer to the Hotspot 2.0 Reference Guide for this release for more information.

### Step 6: Configure the WLAN Service of the Zone Template

Creating a zone template requires that you create the template and configure the services that will be deployed with the template.

Follow these steps to create and configure a WLAN service of an AP zone

**1.** Click **Configuration** > **AP Zones**.

**2.** On the sidebar, click **Zone Templates**.

The **Zone Templates** page appears.

**3.** Click the name of the zone template for which you want to create a WLAN service.

The **Zone Configuration** page appears.

**4.** On the sidebar, click **WLAN**.

**5.** Under the **WLAN Configuration** section, click **Create New**.

The form for creating a new WLAN service appears.

**6.** In the **General Options** section, configure the following options.

- **Name/SSID:** Type a short name (two to 32 alphanumeric characters) for this WLAN. In general, the WLAN name is the same as the advertised SSID (the name of the wireless network as displayed in the client's wireless configuration program). However, you can also separate the SSID from the WLAN name by entering a name for the WLAN in the first field, and a broadcast SSID in the second field. In this way, you can advertise the same SSID in multiple locations (controlled by the same controller) while still being able to manage the different WLANs independently.
- **HESSID** (optional): Type the homogenous extended service set identifier (SSID). The HESSID is a 6-octet MAC address that identifies the homogeneous ESS. The HESSID value must be identical to one of the BSSIDs in the homogeneous ESS.
- **Description:** Type a brief description of the qualifications/purpose for this WLAN (for example, Engineering or Voice).

**7.** In **WLAN Usage**, configure the following:

- In **Access Network**, select the Tunnel WLAN traffic through Ruckus GRE check box if you want to tunnel the traffic from this WLAN back to the controller. Tunnel mode enables wireless clients to roam across different APs on different subnets. If the WLAN has clients that require uninterrupted wireless connection (for example, VoIP devices), Ruckus Wireless recommends enabling tunnel mode. When you enable this option, you need to select core network for tunneling WLAN traffic back to the controller.
  - In **Core Network Type** (only visible if you selected the **Tunnel WLAN traffic through Ruckus GRE** check box), select one of the following core network types:
    - Bridge
    - L3oGRE
    - L2oGRE
    - TTG+PDG
    - PMIPv6
    - Mixed Tunnel Mode
  - In **Authentication Type**, click one of the following options:
    - **Standard usage** (For most regular wireless networks): This is a regular WLAN suitable for most wireless networks.
    - **Hotspot (WISPr)**: Click this option if you want to use a hotspot portal that you previously created. For instructions on how to create a hotspot portal, see [Working with Hotspot \(WISPr\) Portals](#) on page 58.
    - **Guest Access + Hotspot 2.0 Onboarding**: Click this option if you want guest users to use this WLAN. After you complete creating this WLAN for guest access, you can start generating guest passes. For more information, see [Working with Guest Users](#) on page 324.
    - **Web Authentication**: Click this option if you want to require all WLAN users to complete a web-based logon to this network every time they attempt to connect. For more information, see [Working with Web Authentication Portals](#) on page 64.
    - **Hotspot 2.0**: Click this option if you want a Hotspot 2.0 operator profile that you previously created to use this WLAN. For more information, see [Working with Hotspot 2.0 Services](#) on page 67.
8. In **Authentication Options**, click the authentication method by which users will be authenticated prior to gaining access to the WLAN. The level of security should be determined by the purpose of the WLAN you are creating.
- **Open (Default)**: No authentication mechanism is applied to connections. If WPA or WPA2 encryption is used, this implies WPA-PSK authentication.
  - **802.1x EAP**: A very secure authentication/encryption method that requires a back-end authentication server, such as a RADIUS server. Your choice mostly depends on the types of authentication the client devices support and your local network authentication environment.
  - **MAC Address**: Authenticate clients by MAC address. MAC address authentication requires a RADIUS server and uses the MAC address as the user logon name and password. You have two options for the MAC address format to use for authenticating clients:
    - Use user defined text as authentication password (default is device MAC address)

- Set device MAC address in 802.1x format 00-10-A4-23-19-C0. (The default is 0010a42319c0).

**9. In Method under Encryption Options, select an encryption method to use.**

WPA and WPA2 are both encryption methods certified by the Wi-Fi Alliance and are the recommended encryption methods. The Wi-Fi Alliance will be mandating the removal of WEP due to its security vulnerabilities, and Ruckus Wireless recommends against using WEP if possible.

- **WPA:** Standard Wi-Fi Protected Access with either TKIP or AES encryption.
- **WPA2:** Enhanced WPA encryption using stronger TKIP or AES encryption algorithm.
- **WPA-Mixed:** Allows mixed networks of WPA and WPA2 compliant devices. Use this setting if your network has a mixture of older clients that only support WPA and TKIP, and newer client devices that support WPA2 and AES.
- **WEP-64:** Provides a lower level of encryption, and is less secure, using 40-bit WEP encryption.
- **WEP-128:** Provides a higher level of encryption than WEP-64, using a 104-bit key for WEP encryption. However, WEP is inherently less secure than WPA.
- **None:** No encryption; traffic is sent in clear text.

**NOTE:** If you set the encryption method to WEP-64 (40 bit) or WEP-128 (104 bit) and you are using an 802.11n AP for the WLAN, the AP will operate in 802.11g mode.

**10. In Authentication & Accounting Service, configure the following options:**

- **Authentication Service:** This option appears only when 802.1x EAP is selected as the authentication method. Select the authentication server that you want to use for this WLAN. Only AAA servers that you previously added appear here.
- **Accounting Service:** Select the RADIUS Accounting server that you want to use as a proxy for the controller from the drop-down list. You must have added a RADIUS Accounting server previously (see [Step 3: Configure the AAA Servers of the Zone Template](#)).

**11. In Hotspot (WISPr) Portal, select the hotspot that you want this WLAN to use.**

This option appears only when Hotspot (WISPr) is selected as the WLAN usage type. This hotspot portal may be the hotspot that you created in [Step 5: Configure the Hotspot 2.0 Service of the Zone Template](#). Additionally, if you added a RADIUS accounting server to the controller earlier, you can enable RADIUS proxy accounting by selecting the Enable RADIUS Accounting Proxy check box.

**12. In Options, configure the following options:**

- **Wireless Client Isolation:** Wireless client isolation enables subnet restrictions for connected clients. Click **Enable** if you want to prevent wireless clients associated with the same AP from communicating with each other locally. The default value is **Disable**.
- **Priority:** Set the priority of this WLAN to Low if you would prefer that other WLAN traffic takes priority. For example, if you want to prioritize internal traffic over guest WLAN traffic, you can set the priority in the guest WLAN configuration settings to “Low.” By default, all WLANs are set to high priority.

13. In **RADIUS Options**, click **+** (plus sign) to display the options, and then configure the following:

- **RADIUS NAS ID:** Select how the RADIUS server will identify the AP:
  - WLAN BSSID
  - AP MAC
  - User-defined
- **RADIUS NAS Request Timeout:** Type the timeout period (in seconds) after which an expected RADIUS response message is considered to have failed.
- **RADIUS NAS Max Number of Retries:** Type the number of failed connection attempts after which the controller will fail over to the backup RADIUS server.
- **RADIUS NAS Reconnect Primary:** If the controller fails over to the backup RADIUS server, this is the interval (in minutes) at which the controller will recheck the primary RADIUS server if it is available. The default interval is 5 minutes.
- **Called STA ID:** Use WLAN BSSID, AP MAC, AP GROUP, or NONE as the called station ID. Select one.

**NOTE:** Selecting NONE resets both Called and Calling station ID's to empty.

14. In **Advanced Options**, configure the following options:

- **User Traffic Profile:** If you want this WLAN to use a user traffic profile that you previously created, select it from the drop-down menu. Otherwise, select **System Default**. For more information, see [Working with User Traffic Profiles](#) on page 185.
- **L2 Access Control:** If you want this WLAN to use an L2 access control policy that you previously created, select it from the drop-down menu. Otherwise, select **Disable**. For more information, see [Working with Device Policies](#) on page 84.
- **Device Policy:** If you want this WLAN to use a device policy that you previously created, select it from the drop-down menu. Otherwise, select **Disable**. For more information, see [Working with L2 Access Control Policies](#) on page 87.
- **Access VLAN:** By default, all wireless clients associated with APs that the controller is managing are segmented into a single VLAN (with VLAN ID 1). If you want to tag this WLAN traffic with a different VLAN ID, enter a valid VLAN ID (2-4094) in the box.
  - **Enable VLAN Pooling:** If you want to automatically segment large groups of clients (that may or may not be connected to the same SSID) into multiple smaller subgroups using multiple VLANs, select this check box. For more information, see [VLAN Pooling](#) on page 41.
- **Hide SSID:** Click this option if you do not want the ID of this WLAN advertised at any time. This will not affect performance or force the WLAN user to perform any unnecessary tasks.
- **Client Load Balancing:** Improve WLAN performance by enabling load balancing. Load balancing spreads the wireless client load between nearby access points, so that one AP does not get overloaded while another site is idle. Load balancing must be enabled on a per-radio basis. To enable load balancing, select the **Enable loading balancing on [2.4GHz or 5GHz]** check box, and then set or accept the default **Adjacent Radio Threshold** (50dB for the 2.4GHz radio and 43dB for the 5GHz radio).
- **Proxy ARP:** When enabled on a WLAN, the AP provides proxy service for stations when receiving neighbor discovery packets (e.g., ARP request and ICMPv6 Neighbor Solicit



messages), and acts on behalf of the station in delivering ARP replies. When the AP receives a broadcast ARP/Neighbor Solicit request for a known host, the AP replies on behalf of the host. If the AP receives a request for an unknown host, it forwards the request at the rate limit specified.

- **Max Clients:** This option limits the number of clients that can associate with this WLAN per AP (default is 100). You can also limit the total number of clients that a specific AP (or radio, on dual radio APs) will manage.
- **802.11d:** This standard provides specifications for compliance with additional regulatory domains (countries or regions) that were not defined in the original 802.11 standard. Click this option if you are operating in one of these additional regulatory domains.
- **DHCP Option 82:** Select the **Enable DHCP Option 82** check box to enable this feature. When this feature is enabled and an AP receives a DHCP request from a wireless client, the AP will encapsulate additional information (such as VLAN ID, AP name, SSID and MAC address) into the DHCP request packets before forwarding them to the DHCP server. The DHCP server can then use this information to allocate an IP address to the client from a particular DHCP pool based on these parameters.
- **Client TX/RX Statistics:** Select the **Ignore statistics from unauthorized clients** check box if you do not want the controller to monitor traffic statistics for unauthorized clients.
- **Inactivity Timeout:** Select the check box and enter a value in seconds (60 to 600) after which idle clients will be disconnected.
- **Client Fingerprinting:** By selecting this check box, the controller will attempt to identify client devices by their operating system, device type and host name, if available. This makes identifying client devices easier on the **Dashboard**, **Monitor** and **Client Details** pages.
- **OFDM Only:** Select the check box to force clients associated with this WLAN to use only Orthogonal Frequency Division Multiplexing (OFDM) to transmit data. OFDM-only allows the client to increase management frame transmission speed from CCK rates to OFDM rates. This feature is implemented per WLAN and only affects the 2.4GHz radio.
- **BSS Min Rate:** Select this check box to set the bss rates of management frames from default rates (CCK rates for 2.4G or OFDM rate – 6Mbps for 5G] to the desired rates. By default, BSS Min Rate is disabled.

**NOTE:** OFDM-only takes higher priority than BSS-minrate. However, OFDM-only relies on BSS-minrate to adjust its rate for management frames.

- **Mgmt Tx Rate:** To set the transmit rate for management frame, select a value (in Mbps) from the drop-down list.
- **DiffServ Profile:** To apply a DiffServ profile to this WLAN service, select a profile that you previously created. For more information, see [Creating a DiffServ Profile](#) on page 92.
- **Service Schedule:** Use the Service Schedule tool to control which hours of the day, or days of the week to enable/disable WLAN service. Options include:
  - **Always On:** Click to enable this WLAN at all times.
  - **Always Off:** Click to disable the WLAN service at all times.
  - **Specific:** Click to set specific hours during which this WLAN will be enabled. For example, a WLAN for student use at a school can be configured to provide wireless access only during school hours. Click on a day of the week to enable/disable this WLAN for the entire day. Colored cells indicate WLAN enabled. Click and drag to select

specific times of day. You can also disable a WLAN temporarily for testing purposes, for example.

- **Band Balancing:** To disable band balancing on this WLAN, select the **Do not perform band balancing for this WLAN service** check box. For more information, see [Band Balancing](#) on page 77.


**15. Click Create New.**

You have completed creating and configuring a zone template.

## Exporting a Zone Template

If you are planning to create a zone template with settings that are similar to an existing template, you can simply export the existing zone template, import it as a new template, and then edit the settings. You can save time by doing this, instead of creating a new zone template from scratch.

Follow these steps to export a zone template.

1. Go to **Configuration > AP Zones**.
2. On the sidebar, click **Zone Templates**.
3. Locate the zone template that you want to export.
4. Click the  icon that is in the same row as the zone template that you want to export.
5. Alternatively, select the check box before the zone template name, and then click **Export Selected Template(s)**.
6. Your web browser downloads the zone template from the controller.
7. Go to the default download folder that you have configured for your web browser, and then verify that the zone template file (with `.bak` extension) exists.

You have completed exporting a zone template.

## Importing a Zone Template

Follow these steps to import a zone template.

1. Copy the zone template file (with `.bak` extension) to a computer or network location that you can access from the controller web interface.
2. If you are importing the zone template into the same controller, rename the zone template from which you created the file.

If you do not rename the original zone template, the controller will detect that a duplicate zone template exists and the import process will be unsuccessful.

3. To edit a zone template, click the template name on the **Zone Templates** page.
4. When the **Edit Zone Template** form appears, edit the template name, and then click **Apply**.
5. Go to **Configuration > AP Zones**.
6. On the sidebar, click **Zone Templates**.
7. Click **Import**.

The **Importing Zone Template** form appears.

8. Click **Browse**, and then browse to the location where you saved the zone template file.
9. Select the file, and then click **Open**.
10. On the **Importing Zone Template** form, click **Apply**.

A progress bar appears as the controller imports the zone template file.


When the process is complete, the page refreshes, to reflect the zone template that you imported on the list of zone templates.

11. To edit the zone template, click the template name, and then make the changes that you want.

You have completed importing a zone template.

## Deleting a Zone Template

Follow these steps to delete a zone template.

1. Locate the zone template that you want to delete.
2. Click the  icon that is in the same row as the zone template that you want to delete.
3. Alternatively, select the check box before the zone template name, and then click **Delete selected**.

The following confirmation message appears: Are you sure you want to delete the selected row?

4. Click **Yes**.

The page refreshes, and then zone template that you deleted disappears from the list.

You have completed deleting a zone template.

## Working with WLAN Templates

A WLAN template contains configuration settings (AAA server, hotspot, and WLAN settings) that you can apply to all access points that belong to a particular AP zone.

Unlike zone templates, however, WLAN templates will only overwrite the configuration of access points that have the same WLAN name that is defined in the WLAN template. For example, if an access point has two WLANs named Ruckus1 and Ruckus2, and then you apply a WLAN template that contains settings for a WLAN named Ruckus1, the settings of Ruckus1 on the access point (and any other access point that belongs to the same AP zone) will be overwritten by the settings from the WLAN template. The settings of the Ruckus2 WLAN, however, will remain the same.

This section covers:

## Creating and Configuring a WLAN Template

Creating a WLAN template requires that you create the template and configure the services that will be deployed with the template.

Follow these steps to create a WLAN template.

### Step 1: Create the WLAN Template

Creating a WLAN template requires that you create the template and configure the services that will be deployed with the template.

Follow these steps to create a WLAN template.

1. Go to **Configuration > AP Zones**.
2. On the sidebar, click **WLAN Templates**.
3. On the **WLAN Templates** page, click **Create New**.

The **Create New WLAN Template** form appears.

4. In **Template Name**, type a name for the WLAN template that you are creating.
5. In **Description**, type a description for this template.
6. In **Template Firmware**, select the controller firmware version to which to apply this template.
7. In **AP IP Mode**, select the IP addressing mode that you want APs (to which this template will be applied) to use. Options include:
  - IPv4 Only
  - IPv6 Only
  - Dual
8. In **AP SoftGRE Tunnel**, select the **Enable** check box if you want all WLANs created from this template to tunnel traffic to SoftGRE through the AP.
9. Click **Create New** at the bottom of the form.
10. Continue to [Step 2: Configure the AAA Servers for the WLAN Template](#).

The screenshot shows a web form titled "Create New WLAN Template" with an orange header. The form contains the following fields and controls:

- Template Name:** A text input field with an asterisk indicating it is required.
- Description:** A text input field.
- Template Firmware:** A dropdown menu with an asterisk, currently showing "3.2.1.99.567".
- AP IP Mode:** Three radio buttons: "IPv4 only" (selected), "IPv6 only", and "Dual".
- AP SoftGRE Tunnel:** A checkbox labeled "Enable (all WLANs defined in this template will tunnel traffic to SoftGRE via the access point)".
- At the bottom, there are two buttons: "OK" and "Cancel".

Figure 47: The form for creating a WLAN template

### Step 2: Configure the AAA Servers for the WLAN Template

Follow these steps to create and configure an AAA server for the WLAN template.

1. Click **Configuration > AP Zones**.
2. On the sidebar, click **WLAN Templates**.  
The **WLAN Templates** page appears.

3. Click the name of the WLAN template for which you want to create an AAA server.
4. On the sidebar, click **AAA**.  
The **AAA Servers** page appears.
5. Click **Create New**.  
The **Create New Zone RADIUS Server** form appears.
6. Configure **General Options**.
  - **Name:** Type a name for the AAA server that you are adding.
  - **Type:** Select the type of AAA server that you have on the network. Options include:
    - RADIUS
    - RADIUS Accounting
    - Active Directory
    - LDAP
  - **Backup RADIUS:** Select the **Enable backup RADIUS server** check box if a secondary RADIUS server exists on the network. Configure the settings in step 8 on page 125.
7. In the **Primary Server** section, configure the settings of the primary RADIUS server.
  - **IP Address:** Type the IP address of the AAA server.
  - **Port:** Type the port number of the AAA server. The default RADIUS server port number is 1812 and the default RADIUS Accounting server port number is 1813.
  - **Shared Secret:** Type the AAA shared secret.
  - **Confirm Secret:** Retype the shared secret to confirm.
8. In the **Secondary Server** section, configure the settings of the secondary RADIUS server.

**NOTE:** The **Secondary Server** section is only visible if you selected the **Enable backup RADIUS server** check box earlier.

  - **IP Address:** Type the IP address of the secondary AAA server.
  - **Port:** Type the port number of the secondary AAA server port number. The default RADIUS server port number is 1812 and the default RADIUS Accounting server port number is 1813.
  - **Shared Secret:** Type the AAA shared secret.
  - **Confirm Secret:** Retype the shared secret to confirm.
9. Click **Create New** to create the AAA server for the WLAN template.
10. Continue to [Step 3: Configure the Hotspot \(WISPr\) Services of the WLAN Template](#) on page 126.

**Create New RADIUS Service**

**General Options**

Name: \*

Description:

Type:  RADIUS  RADIUS Accounting

Backup RADIUS:  Enable backup RADIUS support → Configure Follower Policy at NAS if this option is enabled

**Health Check Policy**

Response Window: 20 Seconds

Zombie Period: 40 Seconds

Revive Interval: 120 Seconds

No Response Fail:  Yes  No

**Primary Server**

IP Address: \*

Port: \* 1812

Shared Secret: \*

Confirm Secret: \*

**Secondary Server**

IP Address: \*

Port: \* 1812

Shared Secret: \*

Confirm Secret: \*

**Follower Policy at NAS**

Request Timeout: 3 Seconds

Max Number of Retries: 2 Times

Reconnect Primary: 5 Minute(1-86400)

Create Now Cancel

Figure 48: The Create New RADIUS Server form

### Step 3: Configure the Hotspot (WISPr) Services of the WLAN Template

Settings to configure a hotspot portal in the zone template.

NOTE: If you are not providing a hotspot portal to users, skip this section.

If you need more information about hotspots, including third party prerequisites, see [Creating and Managing Hotspots](#) on page 267.

Follow these steps to configure the hotspot settings of the WLAN template.

1. Click **Configuration > AP Zones**.
2. On the sidebar, click **WLAN Templates**.  
The **WLAN Templates** page appears.
3. Click the name of the WLAN template for which you want to create a hotspot portal.
4. On the sidebar, click **Hotspot (WISPr)**.  
The **Hotspot (WISPr) Portal** page appears.
5. Click **Create New**.  
The **Create New Hotspot Portal** form appears.
6. In the **General Options** section, configure the following options:

- **Name:** Type a name for the hotspot portal.
- **Description:** Type a description for the hotspot portal.

7. In the **Redirection** section, configure the following options:

- **Smart Client Support:** Select one of the following options:
  - **None:** Select this option to disable Smart Client support on the hotspot portal.
  - **Enable:** Selection this option to enable Smart Client support.
  - **Only Smart Client Allowed:** Select this option to allow only Smart Clients to connect to the hotspot portal.

For more information, see [.Configuring Smart Client Support](#) on page 279.

- In **Logon URL**, type the URL of the subscriber portal (the page where hotspot users can log in to access the hotspot portal). For more information, see [Configuring the Hotspot Logon URL](#) on page 279.
- In **Start Page**, set where users will be redirected after they log in successfully:
  - **Redirect to the URL that user intends to visit:** You could redirect users to the page that they want to visit.
  - **Redirect to the following URL:** You could set a different page where users will be redirected (for example, your company website).

8. In the **User Session** section, configure the following options:

- **Session Timeout:** Set a time limit (in minutes) after which users will be disconnected from the hotspot portal and will be required to log on again.
- **Grace Period:** Set the time period (in minutes) during which disconnected users are allowed access to the hotspot portal without having to log on again.

9. In the **Location Information** section, configure the following options:

- **Location ID:** Type the ISO and ITU country and area code that the AP includes in accounting and authentication requests. The required code includes:
  - **isocc (ISO-country-code):** The ISO country code that the AP includes in RADIUS authentication and accounting requests.
  - **cc (country-code):** The ITU country code that the AP includes in RADIUS authentication and accounting requests.
  - **ac (area-code):** The ITU area code that the AP includes in RADIUS authentication and accounting requests.
  - network

The following is an example of what the Location ID entry should look like:

```
isocc=us,cc=1,ac=408,network=RuckusWireless
```

- **Location Name:** Type the name of the location of the hotspot portal.

10. In **Walled Garden**, click **Create New** to add a walled garden.

A walled garden is a limited environment to which an unauthenticated user is given access for the purpose of setting up an account.

11. In the box provided, type a URL or IP address to which you want to grant unauthenticated users access.

You can add up to 128 network destinations to the walled garden. Network destinations can be any of the following:

- IP address (for example, 10.11.12.13)
- Exact website address (for example, www.ruckuswireless.com)
- Website address with regular expression (for example, \*.ruckuswireless.com, \*.com, \*)

After the account is established, the user is allowed out of the walled garden. URLs will be resolved to IP addresses. Users will not be able to click through to other URLs that may be presented on a page if that page is hosted on a server with a different IP address. Avoid using common URLs that are translated into many IP addresses (such as www.yahoo.com), as users may be redirected to re-authenticate when they navigate through the page.

12. Click **Create New** to create the hotspot portal of the WLAN template.

13. Continue to [Step 4: Configure the Hotspot 2.0 Services of the WLAN Template](#).

#### Step 4: Configure the Hotspot 2.0 Services of the WLAN Template

To configure a Hotspot 2.0 service, you will need to create and configure at least one service provider profile and one operator profile.

See Hotspot 2.0 Reference Guide for this release for information on how to configure Hotspot 2.0 services using a WLAN template.

#### Step 5: Configure the WLAN Services of the WLAN Template

Creating a WLAN template requires that you create the template and configure the services that will be deployed with the template.

Follow these steps to create and configure a WLAN service of a WLAN template

1. Click **Configuration** > **AP Zones**.
2. On the sidebar, click **WLAN Templates**.

The **WLAN Templates** page appears.

3. Click the name of the WLAN template for which you want to create a WLAN service.
4. On the sidebar, click **WLAN**.
5. Click **Create New**.

The form for creating a new WLAN service appears.

6. In the **General Options** section, configure the following options.
  - **Name/SSID:** Type a short name (two to 32 alphanumeric characters) for this WLAN. In general, the WLAN name is the same as the advertised SSID (the name of the wireless network as displayed in the client's wireless configuration program). However, you can



also separate the SSID from the WLAN name by entering a name for the WLAN in the first field, and a broadcast SSID in the second field. In this way, you can advertise the same SSID in multiple locations (controlled by the same controller) while still being able to manage the different WLANs independently.

- **HESSID:** Type the homogenous extended service set identifier (HESSID). The HESSID is a 6-octet MAC address that identifies the homogeneous ESS. The HESSID value must be identical to one of the BSSIDs in the homogeneous ESS.
- **Description:** Type a brief description of the qualifications/purpose for this WLAN (for example, Engineering or Voice).

7. In **WLAN Usage**, configure the following:

- In **Access Network**, select the **Tunnel WLAN traffic through Ruckus GRE** check box if you want to tunnel the traffic from this WLAN back to the controller. Tunnel mode enables wireless clients to roam across different APs on different subnets. If the WLAN has clients that require uninterrupted wireless connection (for example, VoIP devices), Ruckus Wireless recommends enabling tunnel mode. When you enable this option, you need to select core network for tunneling WLAN traffic back to the controller.
- In **Authentication Type**, click one of the following options:
  - **Standard usage (For most regular wireless networks):** This is a regular WLAN suitable for most wireless networks.
  - **Hotspot (WISPr):** Click this option if you want to use a hotspot portal that you previously created. For instructions on how to create a hotspot portal, see [Working with Hotspot \(WISPr\) Portals](#) on page 58.
  - **Guest Access:** Click this option if you want guest users to use this WLAN. After you complete creating this WLAN for guest access, you can start generating guest passes. See [Working with Guest Users](#) on page 324.
  - **Web Authentication:** Click this option if you want to require all WLAN users to complete a web-based logon to this network every time they attempt to connect. See [Working with Web Authentication Portals](#) on page 64.
  - **Hotspot 2.0:** Click this option if you want a Hotspot 2.0 operator profile that you previously created to use this WLAN. See [Working with Hotspot 2.0 Services](#) on page 67.

8. In **Authentication Options**, click the authentication method by which users will be authenticated prior to gaining access to the WLAN. The level of security should be determined by the purpose of the WLAN you are creating.

- **Open (Default):** No authentication mechanism is applied to connections. If WPA or WPA2 encryption is used, this implies WPA-PSK authentication.
- **802.1x EAP:** A very secure authentication/encryption method that requires a back-end authentication server, such as a RADIUS server. Your choice mostly depends on the types of authentication the client devices support and your local network authentication environment.
- **MAC Address:** Authenticate clients by MAC address. MAC address authentication requires a RADIUS server and uses the MAC address as the user logon name and password. You have two options for the MAC address format to use for authenticating clients:

- Use user defined text as authentication password (default is device MAC address)
- Set device MAC address in 802.1x format 00-10-A4-23-19-C0. (The default is 0010a42319c0).

9. In **Method** under **Encryption Options**, select an encryption method to use.

WPA and WPA2 are both encryption methods certified by the Wi-Fi Alliance and are the recommended encryption methods. The Wi-Fi Alliance will be mandating the removal of WEP due to its security vulnerabilities, and Ruckus Wireless recommends against using WEP if possible.

- **WPA:** Standard Wi-Fi Protected Access with either TKIP or AES encryption.
- **WPA2:** Enhanced WPA encryption using stronger TKIP or AES encryption algorithm.
- **WPA-Mixed:** Allows mixed networks of WPA and WPA2 compliant devices. Use this setting if your network has a mixture of older clients that only support WPA and TKIP, and newer client devices that support WPA2 and AES.
- **WEP-64:** Provides a lower level of encryption, and is less secure, using 40-bit WEP encryption.
- **WEP-128:** Provides a higher level of encryption than WEP-64, using a 104-bit key for WEP encryption. However, WEP is inherently less secure than WPA.
- **None:** No encryption; traffic is sent in clear text.

**NOTE:** If you set the encryption method to WEP-64 (40 bit) or WEP-128 (104 bit) and you are using an 802.11n AP for the WLAN, the AP will operate in 802.11g mode.

10. In **Authentication & Accounting Service**, configure the following options:

- **Authentication Service:** This option appears only when 802.1x EAP is selected as the authentication method. Select the authentication server that you want to use for this WLAN. Only AAA servers that you previously added appear here.
- **Accounting Service:** Select the RADIUS Accounting server that you want to use as a proxy for the controller from the drop-down list. You must have added a RADIUS Accounting server previously (see [Step 2: Configure the AAA Servers for the WLAN Template](#)).

11. In **Hotspot (WISPr) Portal**, select the hotspot that you want this WLAN to use.

This option appears only when Hotspot (WISPr) is selected as the WLAN usage type. This hotspot portal may be the hotspot that you created in [Step 3: Configure the Hotspot \(WISPr\) Services of the WLAN Template](#) on page 126. Additionally, if you added a RADIUS accounting server to the controller earlier, you can enable RADIUS proxy accounting by selecting the Enable RADIUS Accounting Proxy check box.

12. In **Options**, configure the following options:

- **Wireless Client Isolation:** Wireless client isolation enables subnet restrictions for connected clients. Click Enable if you want to prevent wireless clients associated with the same AP from communicating with each other locally. The default value is Disable.
- **Priority:** Set the priority of this WLAN to Low if you would prefer that other WLAN traffic takes priority. For example, if you want to prioritize internal traffic over guest WLAN traffic,

you can set the priority in the guest WLAN configuration settings to "Low." By default, all WLANs are set to high priority.

**13** In **RADIUS Options**, click **+** (plus sign) to display the options, and then configure the following:

- **RADIUS NAS ID:** Select how the RADIUS server will identify the AP:
  - WLAN BSSID
  - AP MAC
  - User-defined
- **RADIUS NAS Request Timeout:** Type the timeout period (in seconds) after which an expected RADIUS response message is considered to have failed.
- **RADIUS NAS Max Number of Retries:** Type the number of failed connection attempts after which the controller will fail over to the backup RADIUS server.
- **RADIUS NAS Reconnect Primary:** If the controller fails over to the backup RADIUS server, this is the interval (in minutes) at which the controller will recheck the primary RADIUS server if it is available. The default interval is 5 minutes.
- **Called STA ID:** Use WLAN BSSID, AP MAC, AP GROUP, or NONE as the called station ID. Select one.

**NOTE:** Selecting NONE resets both Called and Calling station IDs to empty.

**14** In **Advanced Options**, click **+** (plus sign) to display the options, and then configure the following options:

- User **Traffic Profile:** If you want this WLAN to use a user traffic profile that you previously created, select it from the drop-down menu. Otherwise, select **System Default**. For more information, see [Working with User Traffic Profiles](#) on page 185.
- **L2 Access Control:** If you want this WLAN to use an L2 access control policy that you previously created, select it from the drop-down menu. Otherwise, select **Disable**. For more information, see [Working with L2 Access Control Policies](#).
- **Device Policy:** If you want this WLAN to use a device policy that you previously created, select it from the drop-down menu. Otherwise, select **Disable**. For more information, see [Working with Device Policies](#).
- **Access VLAN:** By default, all wireless clients associated with APs that the controller is managing are segmented into a single VLAN (with VLAN ID 1). If you want to tag this WLAN traffic with a different VLAN ID, enter a valid VLAN ID (2-4094) in the box.
  - **Enable VLAN Pooling:** If you want to automatically segment large groups of clients (that may or may not be connected to the same SSID) into multiple smaller subgroups using multiple VLANs, select this check box. For more information, see [VLAN Pooling](#) on page 41.
- **Hide SSID:** Select this check box if you do not want the ID of this WLAN advertised at any time. This will not affect performance or force the WLAN user to perform any unnecessary tasks.
- **Client Load Balancing:** To disable client load balancing on this WLAN, select the **Do not perform client load balancing for this WLAN service** check box. For more information, see [Client Load Balancing](#).

- **Proxy ARP:** Select this check box to enable proxy ARP. When proxy ARP is enabled on a WLAN, the AP provides proxy service for stations when receiving neighbor discovery packets (for example, ARP request and ICMPv6 Neighbor Solicit messages), and acts on behalf of the station in delivering ARP replies. When the AP receives a broadcast ARP/Neighbor Solicit request for a known host, the AP replies on behalf of the host. If the AP receives a request for an unknown host, it forwards the request at the rate limit specified.
- **Max Clients:** This option limits the number of clients that can associate with this WLAN per AP (default is 100). You can also limit the total number of clients that a specific AP (or radio, on dual radio APs) will manage.
- **802.11d:** Select this check box to enable this standard on this WLAN. 802.11d provides specifications for compliance with additional regulatory domains (countries or regions) that were not defined in the original 802.11 standard. Click this option if you are operating in one of these additional regulatory domains.
- **Force DHCP:** Enable this option to force clients to obtain a valid IP address from DHCP within the specified number of seconds. This prevents clients configured with a static IP address from connecting to the WLAN. Additionally, if a client performs Layer 3 roaming between different subnets, in some cases the client sticks to the former IP address. This mechanism optimizes the roaming experience by forcing clients to request a new IP address.
- **DHCP Option 82:** Select the **Enable DHCP Option 82** check box to enable this feature. When this feature is enabled and an AP receives a DHCP request from a wireless client, the AP will encapsulate additional information (such as VLAN ID, AP name, SSID and MAC address) into the DHCP request packets before forwarding them to the DHCP server. The DHCP server can then use this information to allocate an IP address to the client from a particular DHCP pool based on these parameters.
- **Client TX/RX Statistics:** Select the **Ignore statistics from unauthorized clients** check box if you do not want the controller to monitor traffic statistics for unauthorized clients.
- **Inactivity Timeout:** Select this check box and enter a value in seconds (60 to 600) after which idle clients will be disconnected.
- **Client Fingerprinting:** By selecting this check box, the controller will attempt to identify client devices by their operating system, device type and host name, if available. This makes identifying client devices easier on the **Dashboard**, **Monitor** and **Client Details** pages.
- **OFDM Only:** Select the check box to force clients associated with this WLAN to use only Orthogonal Frequency Division Multiplexing (OFDM) to transmit data. OFDM-only allows the client to increase management frame transmission speed from CCK rates to OFDM rates. This feature is implemented per WLAN and only affects the 2.4GHz radio.
- **BSS Min Rate:** Select this check box to set the bss rates of management frames from default rates (CCK rates for 2.4G or OFDM rate – 6Mbps for 5G] to the desired rates. By default, BSS Min Rate is disabled.

**NOTE:** OFDM-only takes higher priority than BSS-minrate. However, OFDM-only relies on BSS-minrate to adjust its rate for management frames.

- **Mgmt Tx Rate:** To set the transmit rate for management frame, select a value (in Mbps) from the drop-down list.

- **Service Schedule:** Use the Service Schedule tool to control which hours of the day, or days of the week to enable/disable WLAN service. Options include:
  - **Always On:** Click this enable this WLAN at all times.
  - **Always Off:** Click this option to disable the WLAN service at all times.
  - **Specific:** Click this to set specific hours during which this WLAN will be enabled. For example, a WLAN for student use at a school can be configured to provide wireless access only during school hours. Click on a day of the week to enable/disable this WLAN for the entire day. Colored cells indicate WLAN enabled. Click and drag to select specific times of day. You can also disable a WLAN temporarily for testing purposes, for example.
- **Band Balancing:** To disable band balancing on this WLAN, select the **Do not perform band balancing for this WLAN service** check box. For more information, see Band Balancing.

15. Click **OK** at the bottom of the form.

You have completed creating and configuring a WLAN template.

## Viewing Existing WLAN Templates





Follow these steps to view the list of WLAN templates created.

1. Click **Configuration > AP Zones**.
2. On the sidebar, click **WLAN Templates**.

The **WLAN Templates** page appears and displays the details of WLAN templates that have been configured on the controller.

**WLAN Templates**

View existing WLAN templates and their basic configuration settings, or create a new one. Use WLAN templates to update the WLAN configuration, including WLAN-only matching WLANs (with exactly the same WLAN names) will be modified. No WLANs will be created or removed in the target zones.

<input type="checkbox"/>	Name ▲	Description	AP Firmware Version	AP IP Mode	Last Modified By	Last Modified On	Actions
<input type="checkbox"/>	wlan-template-1	wlan-template-1	3.1.1.0.313	IPv4	admin	2015/06/30 07:33:44	 
<input type="checkbox"/>	wlan-template-2	wlan-template-2	3.1.1.0.313	IPv4	admin	2015/06/30 07:51:05	 

Show  << | 1 | >>

Figure 49: List view of WLAN templates

## Deleting WLAN Templates

You can delete a single or multiple WLAN templates simultaneously. Follow these steps to delete a single or multiple WLAN templates.

1. Go to **Configuration > AP Zones**.
2. On the sidebar, click **WLAN Templates**.

The **WLAN Templates** page appears.

3. To delete a single WLAN template, follow these steps:

- a) From the list of existing WLAN templates, locate the template that you want to delete.
- b) Under the Actions column, click the icon (🗑️) that is in the same row as the WLAN template.  
A confirmation message appears.

c) Click **Yes**.

The page refreshes and the WLAN template that you deleted disappears from the list.

**4.** To delete multiple WLAN templates simultaneously, follow these steps:

- a) From the list of existing WLAN templates, locate the templates that you want to delete.
- b) Select the check boxes before the templates that you want delete.
- c) Click **Delete Selected**.

A confirmation message appears.

d) Click **Yes**.

The page refreshes and the AAA servers that you deleted disappears from the list.

You have completed deleting single or multiple WLAN templates.

## Templates

Viewing WLAN templates and their basic configuration settings, or create a new one. Use WLAN templates to update the WLAN configuration, including WLANs (with exactly the same WLAN names) will be modified. No WLANs will be created or removed in the target zones.

Create New Delete Selected Search terms:   Include all terms  Include any of these terms

▲	Description	AP Firmware Version	AP IP Mode	Last Modified By	Last Modified On	Actions
<input checked="" type="checkbox"/>	wlan-template-1	3.1.1.0.313	IPv4	admin	2015/06/30 07:33:44	
<input checked="" type="checkbox"/>	wlan-template-2	3.1.1.0.313	IPv4	admin	2015/06/30 07:51:05	

**Figure 50: Deleting multiple WLAN templates simultaneously**

## Working with Registration Rules

Registration rules enable the controller to assign an AP to an AP zone automatically based on the rule that the AP matches.

This section describes the following tasks:

**NOTE:** A registration rule is only applied to an AP the first time it joins the controller. If an AP's MAC address already exists on the controller database (whether it is in connected or disconnected state and whether it belongs to the Staging Zone or any other zone), the controller will assign the AP to its last known AP zone.

### Creating a Registration Rule

Registration rules enable the controller to assign an AP to an AP zone automatically based on the rule that the AP matches.

Follow these steps to create a registration rule.

1. Go to **Configuration > AP Zones**.
2. On the sidebar, click **AP Registration Rules**.

The **AP Registration Rules** page appears.

3. Click **Create New**.

The **AP Registration Rule** form appears.

4. In **Rule Description**, type a name that you want to assign to this rule.
5. In **Rule Type**, click the basis upon which you want to create the rule. Options include:

**NOTE:** The format of the IP address or addresses that you need to enter here depends on the AP IP mode that you selected when you created the AP zone to which this rule will be assigned. If you selected IPv4 Only, enter an IPv4 address. If you selected IPv6 Only, enter an IPv6 address.

- **IP Address Range:** If you select this option, enter the From (starting) and To (ending) IP address that you want to use.
- **Subnet:** If you select this option, enter the IP address and subnet mask pair to use for matching.
- **GPS Coordinates:** If you select this option, type the GPS coordinates to use for matching. Access points that have been assigned the same GPS coordinates will be automatically assigned to the AP zone that you will choose in the next step.

You can choose the Rule Type as GPS coordinates, wherein you must provide information about the latitude, longitude and distance to determine if the AP is within the defined area.

- **Provision Tag:** If the access points that are joining the controller have been configured with provision tags, click the **Provision Tag** option, and then type a tag name in the **Provision Tag** box. Access points with matching tags will be automatically assigned to the AP zone that you will choose in the next step.

**NOTE:** Provision tags can be configured on a per-AP basis from the access point's command line interface.

6. In **Zone Name**, click the down arrow to display available AP zones, and then click the AP zone to which APs that match this rule will be assigned.
7. Click **Create New**.

A progress bar appears as the controller saves the AP registration rule.

When the process is complete, the page refreshes, and then registration rule that you created appears on the **AP Registration Rules** page.

The screenshot shows the 'AP Registration Rule' configuration interface. It features a title bar 'AP Registration Rule' in orange. Below it, there is a 'Rule Description' text field. The 'Rule Type' section has four radio buttons: 'IP Address Range' (selected), 'Subnet', 'GPS Coordinates', and 'Provision Tag'. Under 'IP Address Range', there are two text input fields for 'From IP' and 'To IP'. Below these is a 'Zone Name' dropdown menu with 'No data available' selected. At the bottom, there are 'OK' and 'Cancel' buttons in an orange bar.

**Figure 51: Creating an AP registration rule**

To create another registration rule, repeat the preceding steps. You can create as many registration rules as you need to manage the APs on the network.

### Configuring Registration Rule Priorities



The controller applies registration rules in the same order as they appear in the AP Registration Rules table (highest to lowest priority).

If you want a particular registration rule to have higher priority, you must move it up the table. Once an AP matches a registration rule, the controller assigns the AP to the zone specified in the rule and stops processing the remaining rules.

Follow these steps to configure the registration rule priorities.

1. Go to **Configuration > AP Zones**.
2. On the sidebar, click **AP Registration Rules**.


The **AP Registration Rules** page appears and displays the rules that you have created.

3. Change the priority of each registration rule as required.
4. To give a rule higher priority, move it up the table by clicking the  (up-arrow) icon that is in the same row as the rule name.
5. To give a rule lower priority, move it down the table by clicking the  (down-arrow) icon that is in the same row as the rule name.

When you finish configuring the rule priority, click **Update Priorities** to save your changes.

### Deleting a Registration Rule

Follow these steps to delete a registration rule.

1. On the AP Registration Rules page, select the check box that is in the same row as the registration rule that you want to delete.
2. Click .
- A confirmation message appears.
3. Click **Yes** to confirm that you want to delete the registration rule.



The **AP Registration Rules** page refreshes, and then the registration rule that you deleted disappears from the list.

# 4

## Working with 3rd Party AP Zones

In this chapter:

- [3rd Party AP Zone Types](#)
- [Adding a 3rd Party AP Zone](#)
- [Viewing Existing 3rd Party AP Zones](#)
- [Deleting a 3rd Party AP Zone](#)

The controller connects to 3rd party AP zones the same way as it does to Ruckus Wireless AP zones.

The controller receives RADIUS messages directly from 3rd party APs and supports multiple 3rd party AP zones. It connects to 3rd party AP's using QinQ for data traffic. Access network interface to APs from the controller via QinQ contains UE MAC. 3rd party APs are managed by 3rd party AP controller where the controller acts as a wireless access gateway (WAG). APs are grouped under 3rd party AP zones based on Access C-VLAN and S-VLAN range. Each 3rd party AP zone is identified by a list of IP addresses, ranges, and subnets used by the APs for sending RADIUS traffic to the controller. A 3rd party AP zone ID" is generated internally for each zone. Each 3rd party AP zone is associated with a single "3rd party AP zone".

Supported authentication and accounting procedures are the same as Ruckus Wireless APs.

This section covers:

### 3rd Party AP Zone Types

There are three types of 3rd party AP zones, which are determined by their configuration combinations.

The following configuration combinations determine the type of 3rd party AP zone.

1. Access network type (L2oGRE, Q-in-Q L2)
2. Core network type (TTG+PDG, Bridge)
3. Authentication method (Open, 802.1X, WISPr)

The following table lists the configuration combinations.

**Table 9: Configuration combinations and requirements**

Access (Southbound)	Core (Northbound)	Authentication	Requirements
Q-in-Q L2	TTG+PDG	802.1X	You need to configure: Authentication and Accounting Services User Traffic Profile - TTG+PDG Core network VLAN Options

Access (Southbound)	Core (Northbound)	Authentication	Requirements
			Access Network Q-in-Q VLAN Tags RADIUS Client Options
Q-in-Q L2	Bridge	Hotspot (WISPr) Open	You need to configure: User Traffic Profile - forwarding profile is required Core Network VLAN Options Access Network Q-in-Q VLAN Tags

## Adding a 3rd Party AP Zone

The controller connects to 3rd party AP zones the same way as it does to Ruckus Wireless AP zones.

Follow these steps to add a 3rd Party AP zone service.

**1. Go to Configuration > 3rd Party AP Zones.**

This section displays the details of 3rd Party AP Zones servers that have been configured on the controller.

**2. Click Create New.**

**3. In Name, type a name for the 3rd party AP zone that you are creating.**

**4. In Description, type a brief description of the service that you are creating.**

This is an optional field.

**5. In Access Network, select either QinQ Layer 2 (default) or L2oGRE.**

**6. In Core Network, select either Bridge or TTG+PDG (default).**

**7. In Authentication Service Type, select either Open (default) or Hotspot (WISPr).**

**8. In Access Network Traffic Profile, there should be at least one network traffic profile should be specified for each 3rd Party AP Zone.**

When a new 3rd party AP zone is created, the default network traffic profile specified for the zone is SCG Factory Default network. This is in case the administrator has not specified any other profile.

**9. In User Traffic Profile, there should be at least one user traffic profile specified for each 3rd party AP zone.**

**10. In Core Network VLAN Options, configure the following options:**

- If the core network is Bridge and the access network is Q-in-Q Layer 2:
  - Select the **Enable the Core Network VLAN Type**.
  - Set **Core Network VLAN Mapping Type** to **Strip Access S-VLAN**, preserve Access V-LAN.

- If the core network is TTG+PDG and the access network is Q-in-Q Layer 2:
  - Select the **Enable the Core Network VLAN Type**.
  - Set **Core Network VLAN Mapping Type** to **Strip Access S-VLAN**, preserve Access V-LAN.
- If the core network is Bridge and the access network is L2oGRE:
  - Ensure that the **Enable the Core Network VLAN Type** is not selected.
  - Set **Core Network VLAN Mapping Type** to **Preserve Access VLAN**.
- If core network is Bridge and the access network is L2oGRE:
  - Select the **Enable the Core Network VLAN Type**.
  - Set **Core Network VLAN Mapping Type** to **Add Fixed SVLAN**, Preserve Access VLAN as C-VLAN.

**11.** In Access Network Q-in-Q VLAN tags configuration is required when access network type is Q-in-Q L2.

Access network Q-in-Q VLAN tags configuration defines a list of Q-in-Q tags. These VLAN tags are used to identify the 3rd Party AP Zone for the UE traffic. The controller does not allow duplicate C-VLAN tags within the same zone or across the zones.

- Access Network Source IPs configuration is required when access network type is L2oGRE. Access network IP addresses configuration defines a list of IP ranges. These IP ranges identify the 3rd Party AP Zone for the UE traffic. The controller does not allow overlapping IP ranges within the same zone or across the zones.

**12** RADIUS client options needs to be configured if the core network type is TTG+PDG and authentication type is 802.1X.

RADIUS client default secret is required. The IP ranges should not be overlapping within the same zone or across zones. The share secret for each IP range is not required.

**13** Click **Create New**.

You have completed adding a new 3rd party AP zone service.

Figure 52: The Create New 3rd Party AP Zone form

## Viewing Existing 3rd Party AP Zones

To view a list of 3rd party AP zones that have been created, go to **Configuration > 3rd Party AP Zones**.

The 3rd party AP zones that have been configured on the controller appear on the list.

### 3rd Party AP Zone List

View existing third party AP zones in the selected domain and their basic configuration settings, or create a new one.

Refresh Create New Move Selected Delete Selected Search terms:   Include all terms  Include any of these terms

Load Criteria: Management Domain = "Administration Domain"

<input type="checkbox"/>	Zone Name ▲	Description	Access Network Type	Last Modified...	Last Modified On	Actions
<input type="checkbox"/>	3rd-party-test-1		Q-in-Q Layer 2	admin	2015/03/16 15:40:25	
<input type="checkbox"/>	3rd-party-test-2		L2oGRE	admin	2015/03/16 15:41:28	

Show  << | 1 | >>

Figure 53: The 3rd Party AP Zone List page

## Deleting a 3rd Party AP Zone

Follow these steps to delete a 3rd party AP zone.

1. In the **3rd Party AP Zone** section, locate the AP zone that you want to delete.
2. Under the **Actions** column, click the icon that is in the same row as the zone name.  
A confirmation message appears.
3. Click **Yes**.  
The page refreshes, and the AP zone that you deleted disappears from the **3rd Party Zone List** page.

You have completed deleting a 3rd party AP zone.

# Managing Access Points

In this chapter:

- [Overview of Access Point Configuration](#)
- [Viewing Managed Access Points](#)
- [Provisioning and Swapping Access Points](#)
- [Editing AP Configuration](#)
- [Editing Swap Configuration](#)
- [Moving a Single Access Point to a Different AP Zone](#)
- [Moving Multiple Access Points to a Different AP Zone](#)
- [Deleting an Access Point](#)

In this chapter:

## Overview of Access Point Configuration

Once you have created registration rules and the AP zones to which joining access points can be assigned automatically, access points will be able to join or register with the controller automatically.

After an access point registers successfully with the controller, you can update its configuration by following the steps described in this section.

## Viewing Managed Access Points

After an access point registers successfully with the controller, it appears on the Access Points page, along with other managed access points.

Follow these steps to view a list of managed access points.

### 1. Go to **Configuration** > **Access Points**.

A list of access points that are being managed by the controller appears on the **Access Points in Management Domain** page. These are all the access points that belong to all management domains.

The list of managed access points displays details about each access point, including its:

- AP MAC address
- AP name
- Zone (AP zone)
- Model (AP model)
- AP firmware
- IP address (internal IP address)
- External IP address

- Provision Method
- Provision State
- Administrative Status
- Status
- Configuration Status
- Registered On (date the access point joined the controller network)
- Registration Details
- Registration State
- Actions (actions that you can perform)

**NOTE:** By default, the **Access Points** page displays 20 access points per page (although you have the option to display up to 250 access points per page). If the controller is managing more than 20 access points, the pagination links at the bottom of the page are active. Click these pagination links to view the succeeding pages on which the remaining access points are listed.

2. To view access points that belong to a particular administration domain, click the name of the administration domain in the domain tree (on the sidebar).

The page refreshes, and then displays all access points that belong to that management domain.

AP List

View a list of managed APs that belong to the selected zone or domain and their basic configuration settings. To filter the AP list, click **Load Criteria**, and then configure the filters that you want to apply.

Refresh Import Export Move Selected Delete Selected Search terms:  Include all terms Include any of these terms Table Layout

▼ Load Criteria: Domain = "Administration Domain"

AP MAC Address	AP Name	Zone	AP Group	Model	AP Firmware	IP Address	External IP Add...	Provision Method	Provision Stage	Administrative State	Status	Configu
94:F6:65:14:C8:90	RuckusAP	Staging Zone		R710	3.2.0.99.510	2001:b030:25...	[2001:b030:251...	Discovered		Unlocked	Discovery	

Figure 54: Viewing a list of managed access points

## Provisioning and Swapping Access Points

The controller supports the provisioning and swapping of access points.

As an administrator you can:

- Upload a file containing list of AP and the pre-provisioned configuration data for each AP. The controller processes the file and provides details on regarding the import results (including a list of failed APs and failure reasons).
- Modify or delete pre-provisioning data if AP does not connect to the controller
- Monitor the status and stage of the pre-provisioned APs
- Manually lock or unlock APs
- Upload a file containing list of AP pairs for swapping. The controller processes the file and provide the detailed import result (including a list of failed APs and failure reasons).
- Manually enter the AP swap pair
- Delete the swap configuration if AP fails to contact the controller
- Monitor the status and stage of the swapping AP pairs



- Manually swap the APs

## Options for Provisioning and Swapping APs

The controller supports the provisioning and swapping of access points.

Use the following buttons on the AP List page to perform the AP provisioning and swapping.

- **Import Batch Provisioning APs:** Click this button to import the provisioning file. The controller displays the import results. Any errors that occur during the import process will be listed by the controller.
- **Export All Batch Provisioning APs:** Click this button to download a CSV file that lists all APs that have been provisioned. The exported CSV contains the following information:
  - AP MAC Address
  - Zone Name
  - Model
  - AP Name
  - Description
  - Location
  - GPS Coordinates
  - Logon ID
  - Password
  - Administrative State
  - IP Address
  - Network Mask
  - Gateway
  - Primary DNS
  - Secondary DNS

**NOTE:** The exported CSV file for all batch provisioned APs only contains pre-provisioned APs. It does not contain swapping APs or auto discovered APs.

If no APs have been pre-provisioned, you will still be able to export the CSV file but it will be empty (except for the column titles).

- **Import Swapping APs:** Manually trigger the swapping of two APs by clicking the swap action in the row. You can also edit the pre-provision configuration only if the AP does not connect to the controller. Click the AP MAC address to bring up the configuration edit form, and then select **Pre-provision Configuration**.
- **Export All Batch Swapping APs:** Click this button to download a CSV file that lists all APs that have been swapped. The exported CSV contains the following information:
  - Swap In AP MAC
  - Swap In AP Model
  - Swap Out AP MAC

**NOTE:** The exported CSV file for batch swapping APs only contains swapping APs. It does not contain pre-provisioned APs or auto discovered APs.

- Delete Selected:** To delete multiple pre-provisioned APs simultaneously, select the check boxes before the AP MAC addresses, and then click **Delete Selected**. To delete a single pre-provisioned AP, click the icon that is in the same row as the AP MAC address. If the AP has not contacted the controller, the AP record disappears from the table. If the AP comes up later, the controller treats it as a discovered AP. If the AP is connected to the controller, the delete operation is similar to the AP delete operation.

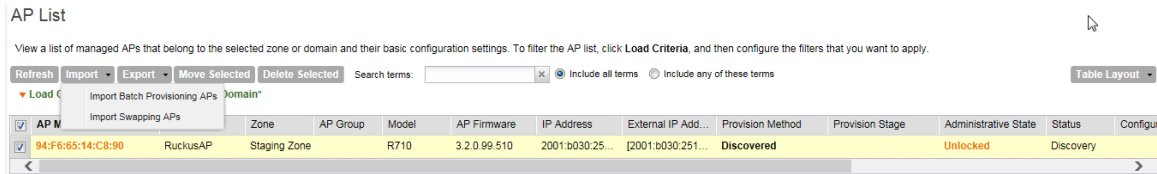


Figure 55: Options for provisioning and swapping APs

## Understanding How Swapping Works

The following table lists how the controller handles swapping by detailing each stage. For example, you have entered swap configuration as Swap In: A and Swap out: B.

Table 10: AP swapping stages

Stage	State A	Stage A	State B	Stage B
1. Enter data	Swapping	Not Registered	Approved	Waiting for swap in AP registration
2. AP register	Swapping	Waiting for swapping in	Approved	Waiting for swapping out
3. User swap	Approved	Swapped in	Swapping	Swapped out
4: Second swap	Swapping	Swapped out and waiting for swapping in	Approved	Swapped in and waiting for swapping out

## Editing AP Configuration

Follow these steps to update the configuration of a managed access point.

- On the **AP List** page, locate the access point whose configuration you want to update.
- Click the MAC address of the access point.

The **AP configuration** form appears.

- Update the access point configuration by modifying the options in the form.
- Click **OK**.

You have completed editing the AP configuration.

**NOTE:** The loc parameter (which holds the Location attribute in the AP configuration) in the controller's Captive Portal redirection to the configured hotspot login portal is encoded using the Hex encoder from the org.apache.commons.codec.binary library. If you have hotspots on the network and you are using an external portal, take note of the encoding mechanism for the loc parameter so your external portal can decode it.

The screenshot shows the 'AP Configuration' form with two tabs: 'AP Configuration' and 'Swap Configuration'. The 'General Options' section includes fields for AP Name (RuckusAP), Description, Location (Bangalore), Location Additional Information (Ruckus-BDC), GPS Coordinates (Latitude: 11.2345, Longitude: 22.3456), Country Code (United States), User Location Information (ULI) (Area Code: 255, Cell Identifier: 3), and AP Admin Logon (Logon ID: admin, Password: \*\*\*\*\*). The 'Radio Options' section is divided into 'Radio Options b/g/n (2.4 GHz)' and 'Radio Options a/n (5 GHz)'. The 2.4 GHz section includes Channel Range (2.4G) with checkboxes 1-11, Channel Range (5G) with checkboxes 36-16, and sub-sections for Channelization (20), Channel (Auto), TX Power Adjustment (Full/Auto), WLAN Group (default), and WLAN Service (checked). The 5 GHz section includes Channelization (40), Channel (Auto), TX Power Adjustment (Full/Auto), WLAN Group (default), and WLAN Service (checked). Below the radio options are sections for AP SNMP Options, Model Specific Options, and Advanced Options.

Figure 56: The AP Configuration form

## Editing Swap Configuration

The controller supports the swapping or replacement of a managed AP with a new AP of the same model. This feature is useful when you want to avoid service interruption because you need to replace an AP in the field.

By configuring the swap settings, you can easily and automatically export and apply the settings of the old AP to the new AP.

Follow these steps to configure the swap settings of an AP.

1. On the **AP List** page, locate the access point whose swap configuration you want to update.
2. Click the AP MAC address of the access point.
3. Click the **Swap Configuration** tab.
4. Update the access point configuration by modifying the options in the form.
5. Click **OK**.

You have completed editing the swap configuration.


The screenshot shows a web-based configuration form with two tabs: "AP Configuration" and "Swap Configuration". The "Swap Configuration" tab is selected. The form includes a checked checkbox labeled "Add Swap in AP". Below this are three input fields: "Swap In AP MAC:" containing "ZF7365" (highlighted with a red border), "Swap In AP Model:" containing "ZF7363", and "Swap Out AP MAC:" containing "58:93:96:13:EC:B0". At the bottom of the form are "Apply" and "Close" buttons.

Figure 57: The Swap Configuration form

## Moving a Single Access Point to a Different AP Zone

Follow these steps to move a single access point from its current AP zone to a different one.

**NOTE:** The AP that you move will inherit the configuration of the new AP zone.

1. On the **AP List** page, locate the access point that you want to move to a different AP zone.
2. Once you locate the access point, click the  icon that is under the **Actions** column.

The **Select a Destination AP Zone** form appears.

3. Select the AP zone to which you want to move the access point.
4. Click **OK**.

You have completed moving an access point to a new AP zone.

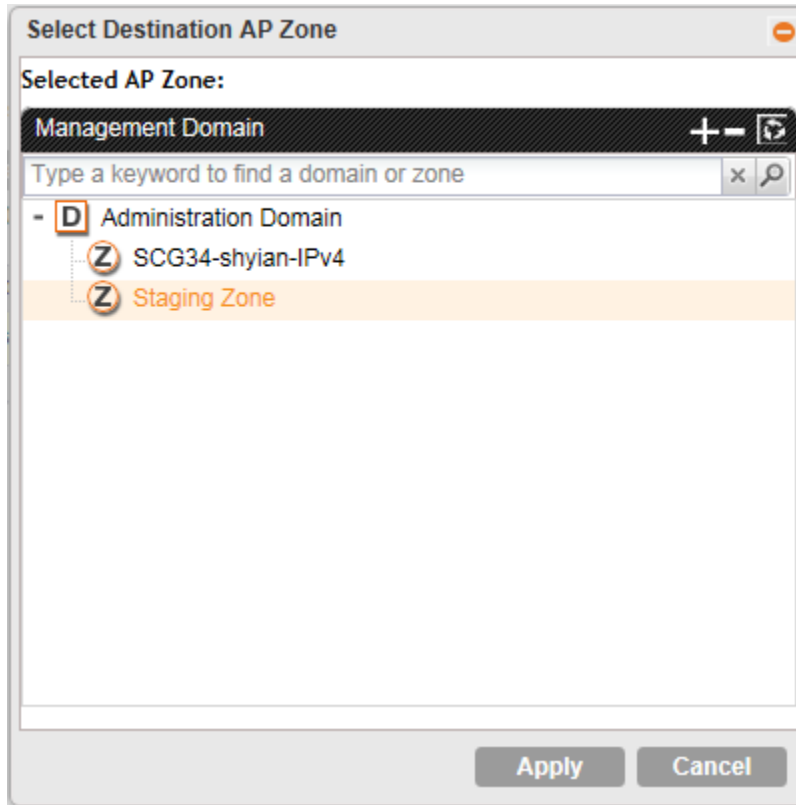


Figure 58: Selecting and moving an access point

## Moving Multiple Access Points to a Different AP Zone

Follow these steps to move multiple access points to a different AP zone simultaneously.

1. On the **AP List** page, locate the access points that you want to move to a different AP zone.
2. Once you locate the access points that you want to move, select the check boxes before their MAC addresses.
3. Click the **Move Selected** button that is above the access points table.

The **Select Destination AP Zone** form appears.

4. Select the AP zone to which you want to move the access points.
5. Click **OK**.

You have completed moving the selected access points to a new AP zone.

## Deleting an Access Point

Follow these steps to delete an access point that is currently registered with the controller.

1. On the **AP List** page, locate the access point that you want to delete.
2. Once you locate the access point, click the icon that is under the **Actions** column.

A confirmation message appears.

**3. Click OK.**

The list of managed access points refreshes, and then the access point that you deleted disappears from the list.

**NOTE:** Wireless clients that are associated with the access point that you deleted will still be able to connect to the network until the next time the access point attempts to rejoin the controller. When these access points attempt to rejoin the controller (through a discovery process), they will be placed in a new AP zone if they match an existing AP registration rule. If they do not match an AP registration rule, they will be placed automatically in the **Staging Zone**, at which point wireless clients associated with these access points will lose network connectivity.

After you delete an access point, it could take approximately two minutes before it appears in the **Staging Zone** again (if the access point does not match an existing AP registration rule). After the access point appears in the **Staging Zone**, it may continue to broadcast the previous SSID for the next five minutes, after which it will stop.

# Configuring Services and Profiles

# 6

In this chapter:

- [Configuring the GGSN/PGW Service](#)
- [Configuring Authentication Services](#)
- [Configuring HLR Services](#)
- [Configuring Diameter Services](#)
- [Configuring FTP Services](#)
- [Configuring Location Services](#)
- [Configuring an SMS Server](#)
- [Working with Profiles](#)

In this chapter:

## Configuring the GGSN/PGW Service

The controller has 3GPP defined Tunnel Terminating Gateway (TTG) functionality, which enables it to act as a gateway between the UE (southbound) and the telecom core (northbound) to tunnel traffic between the UE (user equipment, such as mobile phones).

The controller gateway terminates the tunnel, and then transfers the data over to GGSN (Gateway GPRS serving node) implementing the Gn' interface via GTPv1 (Release 6).

The Gn interface is used in controlling the signal between controller and GGSN as well as for tunneling end user data payload within the backbone network between both the nodes.

GPRS Tunneling Protocol (GTP) transmits user data packets and signaling between controller and GGSN. GTP encapsulates traffic and creates GTP tunnels, which act as virtual data channels for transmission of packet data between the controller and GGSN. A GTP tunnel is established between the controller and GGSN for a data session initiated from UE.

A GTP tunnel is identified by a pair of IP addresses and a pair of GTP Tunnel End Point Identifiers (TEIDs), where one IP address and TEID is for the SGSN and the other is for GGSN. TEID is a session identifier used by GTP protocol entities in SGSN and GGSN.

GTP separates signaling from payload. Traffic is sorted onto a control plane (GTP-C) for signaling and a user plane (GTP-U) for user data. GTP-C is a tunnel control and management protocol and is used to create, modify and delete tunnels. GTP-U is a tunneling mechanism that provides a service for carrying user data packets.

Clicking **Configuration** > **Services & Profiles** on the main menu displays a sidebar on the left side of the page, which includes **GGSN Services**. [Figure 59](#) shows the **GGSN Service configuration** page.

## GGSN/PGW

**GTP Common Configuration**

Response Timer (2-5 Seconds): \* 3

Number of Retries (N3 3-6): \* 5

Echo Request Timer (60-300 Seconds): \* 60

DNS Response Timeout (secs): \* 3

DNS # of Retry: \* 3

**DNS Servers**

IP Add Server

**APN Resolution**

Create New Delete Selected

Domain Name	IP	Actions
ruckus.com	10.1.13.19	🗑️

Refresh Apply Cancel

**Figure 59: The GGSN services configuration page**

Follow these steps to configure the GGSN/PGW service.

1. Go to **Configuration > Services & Profiles**.
2. On the sidebar (under **Services**), click **GGSN**.
3. In the **GTP Common Configuration** section, configure the following options:
  - **Response Timer:** Define the response expected from GGSN server from the drop down list, which ranges from 2 to 5 seconds. The controller will try contacting GGSN during a call establishment.
  - **Number of Retries:** Define the number of times that the controller will attempt to contact the GGSN. If all attempts fail, the relevant alarm is raised to confirm the failure of the GGSN path. For example, if the response timer is 3 and the number of retries is 5, it means that for each retry, the controller will attempt to contact the GGSN for 3 seconds.
  - **Echo Request Timer:** Define number of seconds that the GGSN waits before sending an echo-request message to check for GTP path failure.
  - **DNS Response Time:** Specify the maximum time that DNS waits for a response from a signaling request message.
  - **DNS # Retry:** specify the maximum number of times that the DNS attempts to send a signaling request.
4. In the **DNS Servers** section, click **Add Server** to add a DNS IP address.

If you're adding multiple DNS IP addresses, you can set their priority by clicking the **Move Up** and **Move Down** buttons. DNS servers that are higher up on the list of servers are given higher priority.
5. In the **APN Resolution** section, click **Create New** to define the IP address of the GGSN that should serve the AP.
6. Configure the following options:
  - **Domain Name:** Type the GGSN domain name.
  - **IP Address:** Type the GGSN IP address.



7. Click **Apply**.

You have completed configuring the GGSN service.

## Configuring Authentication Services

An authentication service defines the external authentication server that the controller will use to authenticate wireless users.

This section covers:

**NOTE:** If you want to use primary and secondary RADIUS servers for authenticating administrators, see [Adding a RADIUS Server for Administrators](#) on page 254.

### Adding an Authentication Service

An authentication service defines the external authentication server configuration. Radius services authenticates profiles to specify external Radius services used based on the real value.

Follow these steps to add an authentication service that the controller can use.

1. Go to **Configuration > Services & Profiles**.

2. On the sidebar (under **Services**), click **Authentication**.

The **Authentication** page appears.

3. Click **Create New**.

The **Create New Authentication Service** form appears.

4. In **Name**, type a name for the authentication service that you are adding.

5. In **Friendly Name** (optional), type an alternative name that is easy to remember.

6. In **Description** (optional), type a description for the authentication service.

7. In **Service Protocol**, select one of the following options:

- RADIUS (see [RADIUS Service Options](#))
- Active Directory
- LDAP
- OAuth
- HLR

8. Configure the settings for the authentication service type that you selected.

**NOTE:** User Traffic Profiles mapped under Authentication services are not supported for WLANs except Hotspot 2.0 WLANs.

9. Click **OK**.

The page refreshes and the authentication service you have added appears on the list of existing authentication services.

You have completed adding an authentication service to the controller.

**Create New Authentication Service**

Name: \*

Friendly Name:

Description:

Service Protocol: \*  RADIUS  Active Directory  LDAP  OAuth  HLR

**RADIUS Service Options**

RFC 5580 Out of Band Location Delivery:  Enable for Ruckus AP Only

**Primary Server**

IP Address: \*

Port: \* 1812

Shared Secret: \*

Confirm Secret: \*

**Secondary Server**

Backup RADIUS:  Enable Secondary Server  Automatic Fallback Disable

IP Address: \*

Port: \* 1812

Shared Secret: \*

Confirm Secret: \*

**Health Check Policy**

Response Window: 20 Seconds

Zombie Period: 40 Seconds

Revive Interval: 120 Seconds

No Response Fail: \*  Yes  No

**Rate Limiting**

Maximum Outstanding Requests (MOR): 0 Requests per Server

Threshold: 0 % of MOR

Sanity Timer: 10 Seconds

Figure 60: The Create New Authentication Service form

### RADIUS Service Options

RADIUS services authenticate profiles to specify external RADIUS services used based on the realm value.

If you selected RADIUS in [Adding an Authentication Service](#), you need to configure the following options

- **RFC 5580 Out of Band Location Delivery:** If you want out-of-band location delivery (RFC 5580) to apply only to Ruckus Wireless APs, select the **Enable for Ruckus AP Only** check box.
- **Primary Server:** Configure the primary RADIUS server settings.
  - **IP Address:** Type the IP address of the RADIUS server.
  - **Port:** Type the port number of the RADIUS server. The default RADIUS server port number is 1812 and the default RADIUS Accounting server port number is 1813.
  - **Shared Secret:** Type the RADIUS shared secret.
  - **Confirm Secret:** Retype the shared secret to confirm.

- **Secondary Server:** If you have a secondary RADIUS server on the network that you want to use as a backup, select the **Enable Secondary Server** check box, and then configure the settings below.

- **Automatic Fallback Disable:** By default, when a secondary RADIUS server is enabled and the primary RADIUS server becomes unavailable, the secondary server takes over the handling of RADIUS requests. When the primary server becomes available again, it takes back control over RADIUS requests from the secondary server.

If you want to prevent the primary server from retaking control over RADIUS requests from the secondary server, select the **Automatic Fallback Disable** check box.

- **IP Address:** Type the IP address of the secondary AAA server.
  - **Port:** Type the port number of the secondary AAA server port number. The default RADIUS server port number is 1812 and the default RADIUS Accounting server port number is 1813.
  - **Shared Secret:** Type the AAA shared secret.
  - **Confirm Secret:** Retype the shared secret to confirm.
- **Health Check Policy:** These options define the health monitoring settings of the primary and secondary RADIUS servers, when the controller is configured as RADIUS proxy for RADIUS Authentication and Accounting messages.
    - **Response Window:** Set the time (in seconds) after which, if the AAA server does not respond to a request, the controller will initiate the “zombie period” (see below). If the primary AAA server does not respond to RADIUS messages sent after **Response Window** expires, the controller will forward the retransmitted RADIUS messages to the secondary AAA server. Note that the zombie period is not started immediately after the Response Window expires, but after the configured **Response Window** plus  $\frac{1}{4}$  of the configured **Zombie Period**. The default **Response Window** is 20 seconds.
    - **Zombie Period:** Set the time (in seconds) after which, if the AAA server does not respond to ANY packets during the zombie period, it will be considered to inactive or unreachable. An AAA server that is marked “zombie” (inactive or unreachable) will be used for proxying with a low priority. If there are other live AAA servers, the controller will attempt to use these servers first instead of the zombie AAA server. The controller will only proxy requests to a zombie server only when there are no other live servers. Any request that is proxied to an AAA server will continue to be sent to that AAA server until the home server is marked inactive or unreachable. At that point, the request will fail over to another server, if a live AAA server is available. The default **Zombie Period** is 40 seconds.
    - **Revive Interval:** Set the time (in seconds) after which, if no RADIUS messages are proxied to the AAA server after it has been marked as inactive or unreachable, the controller will mark the AAA server as active again (and assume that it has become reachable again). The default **Revive Interval** is 120 seconds.
    - **No Response Fail:** Click **Yes** to respond with a reject message to the NAS if no response is received from the RADIUS server. Click **No** to skip sending a response.

**NOTE:** To ensure that the RADIUS failover mechanism functions correctly, either accept the default values for the **Response Window**, **Zombie Period**, and **Revive Interval**, or make sure that the value for Response Window is always higher than the value for RADIUS NAS request timeout multiplied by the value for RADIUS NAS max number of retries. For

information on configuring the RADIUS NAS request timeout and max number of retries, see [Working with WLANs and WLAN Groups](#). For 3rd party APs, you must ensure that the configured **Response Window** on the controller is higher than the RADIUS NAS request timeout multiplied by the RADIUS value. The maximum number of retries is configured at 3rd party controller/ AP.

- **Rate Limiting:** This is set at the controller, and the controller drops the Radius Request messages when the configured rate limit has been reached. Configure the following options.

- **Maximum Outstanding Requests (MOR):** Set the maximum number of outstanding requests (RADIUS messages for which the controller is awaiting a reply) per server. Type 0 to disable it, or set a value between 10 and 4096.

For example, if the AAA server is configured to only handle 100 Authentication Requests at any time, then MOR can be set to 100 under the controller's Authentication Services page. When the MOR limit is reached for any AAA server, the controller raises event 1302, *Rate limit for TOR surpassed*.

- **Threshold (% of MOR):** Set a percentage value of the MOR at which the controller will generate an event. For example, if the MOR is set to 1000 and the threshold is set to 50%, the controller will generate an event when the number of outstanding requests reaches 500. This value notifies the user about the increasing load on a AAA server by raising an event.

For example, if the MOR is set to 100 and the Threshold is set to 80%, when the number of outstanding requests sent to the AAA server are 80, event 1300, *Rate Limit Threshold Surpassed* is raised. The controller continues to proxy the AAA server until it reaches 100.

- **Sanity Timer:** Set a timer (in seconds) that will be started whenever a condition that generates an event is reached. This helps prevent excessive events for conditions that fluctuate frequently, and especially useful in avoiding false alarms for flickering peak traffic.

Since Rate Limiting is enforced uniquely for each server, administrators must consider the load capacity from both Authentication and Accounting services together for a AAA server when the same AAA server is used for both Authentication and Accounting Services

- **User Traffic Profile Mapping**

Follow these steps to configure the user traffic profile:

- Type a **Group Attribute Value**.
- Select a **User Role** from the drop-down list.
- Click **Add**.

The mapped user profile is listed.

## Testing the AAA Server Configuration

The test AAA server holds the information of authentication or accounting server, including the server IP, service port, shared secret and other settings of the current user.

If the requested service is successful, the API will display the information.

**NOTE:** Before you can test the AAA server configuration, you must have created an AAA server. See [Adding an Authentication Service](#) for more information.

Follow these steps to test the AAA server configuration.

1. Go to **Configuration > Services & Profiles**.

2. On the sidebar under **Services**, click **RADIUS**.

The **RADIUS Services** page appears.

3. Click **Test AAA**.

The **Test AAA Servers** form appears.

4. Configure the options in the **Test AAA Servers** form.

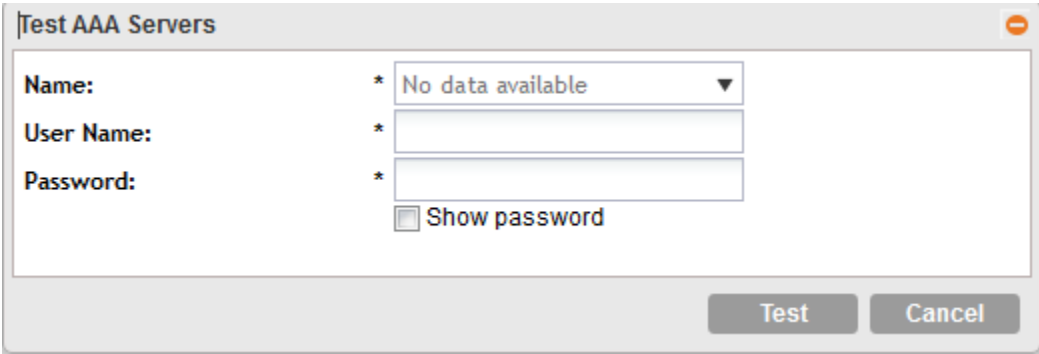
- **Name:** Select the name of the RADIUS server that you want to test.
- **User Name:** Type the RADIUS user name that you want to use for testing.
- In **Protocol:** Select the Password Authentication Protocol (PAP), or the Challenge Handshake Authentication Protocol (CHAP) to authenticate the AAA server.
- **Password:** Type the RADIUS password for the user.
- **Confirm Password:** Retype the RADIUS password above.

5. Click **Test**.

The message `Please wait...` appears.

If the service request fails, a relevant error message is displayed. Similarly, if the user name or password is incorrect, the error message includes this information along with the server IP address and port. If the server IP address, port, or shared secret is incorrect, the connection to AAA server fails and the error message `Invalid server setting` appears and displays the server IP address and port.

If both primary and secondary servers exist, the requested service will be interrupted when controller meets a failure and an error message is displayed.



**Figure 61: The Test AAA Servers form**

## Viewing RADIUS Services

RADIUS services authenticates profiles to specify external RADIUS services used based on the realm value.

Follow these steps to view a list of RADIUS servers that have been configured on the controller.

1. Go to **Configuration > Services & Profiles**.
2. On the sidebar under **Services**, click **RADIUS**.

The **RADIUS Services** page appears and displays a list of RADIUS servers that have been configured on the controller. RADIUS details that are shown on the RADIUS services page include:

- **Name**
- **Description**
- **Type:** RADIUS or RADIUS Accounting
- **Primary IP**
- **Secondary IP**
- **Last Modified By**
- **Last Modified On**
- **Actions**

You have completed viewing a list of RADIUS services.

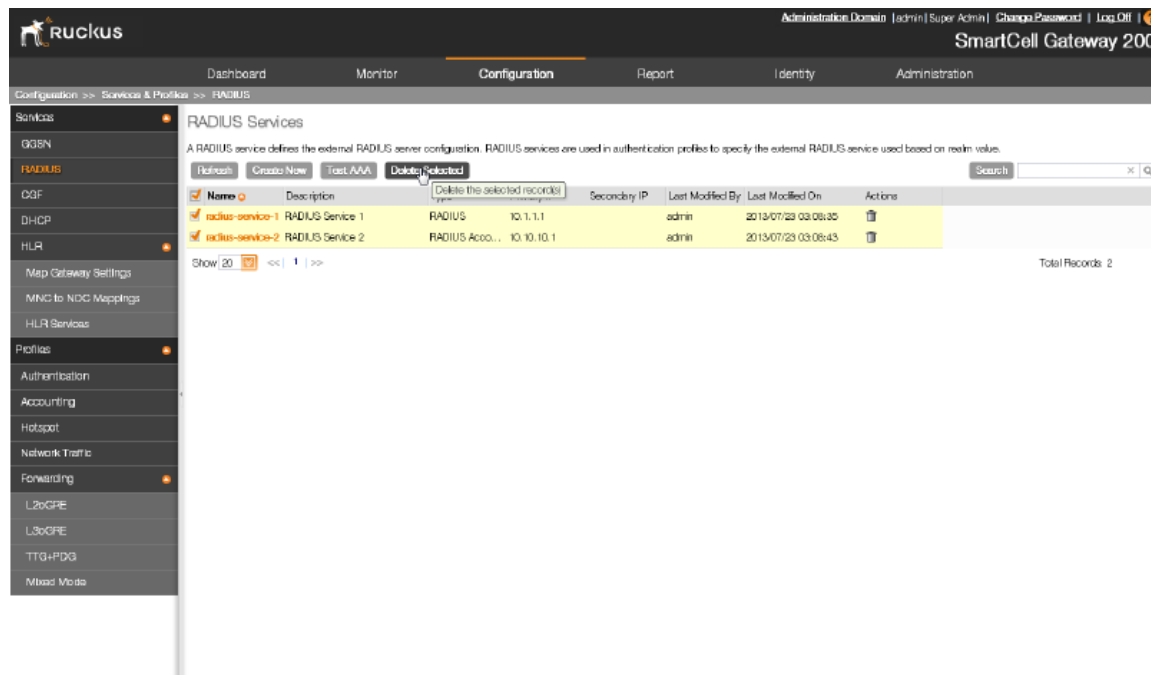



Figure 62: Viewing a list of RADIUS services

## Deleting a Single RADIUS Service

You can delete a single or multiple RADIUS services simultaneously.

To delete a single RADIUS service, follow these steps:

1. Go to **Configuration > Services & Profiles**.
2. On the sidebar under **Services**, click **Authentication**.  
The **Authentication Services** page appears.
3. From the list of existing authentication servers, locate the RADIUS server that you want to delete.
4. Under the **Actions** column, click  that is in the same row as the RADIUS service name.  
A confirmation message appears.  
  
**NOTE:** If a service is mapped to a profile, you cannot delete the service until the profile is deleted from the Authentication Service.
5. Click **Yes**.
6. The page refreshes, and the RADIUS service that you deleted disappears from the view list.

### Deleting Multiple RADIUS Services

1. Go to **Configuration > Services & Profiles**.
2. On the sidebar under **Services**, click **RADIUS**.  
The **RADIUS Services** page appears.
3. From the list of existing RADIUS services, locate the services that you want to delete.
4. Select the check boxes before the services that you want delete.
5. Click **Delete Selected**.  
A confirmation message appears.
6. Click **Yes**.  
The page refreshes and the RADIUS services that you deleted disappears from the list.

**Figure 63: Deleting multiple RADIUS services simultaneously**

## Configuring HLR Services

The controller and multiple Home Location Registers (HLRs) manage a wireless services gateway for performing authentication/ authorization and for unsolicited changes of authorization.

This section covers:

### Map Gateway Settings

Configure the MAP gateway settings to set up multiple HLRs for performing authentication and/or authorization and for unsolicited changes of authorization. The MAP gateway is responsible for initiating MAP queries with the UE's home HLR. Since the MAP gateway may interface with multiple HLRs, the route to the home HLR is selected based on the realm information.

The following configuration settings apply to all the HLR services configured on the controller. Follow these steps to configure a MAP gateway settings for the HLR service.

**NOTE:** Changes to these settings could cause critical controller processes to restart.

1. Go to **Configuration > Services & Profiles**.
2. On the sidebar under **Services**, click **HLR**.
3. Click **Map Gateway Settings** on the sidebar under **HLR**.
4. Configure **Map Gateway Settings**.
  - **Traffic Mode:** This setting is always set to **Load\_Share** and is not configurable.
  - **Protocol Variant:** This setting is always set to **ITU** and is not configurable.
  - **Local Network Indicator:** Select either **International** or **National**.
5. Click **Apply**.

You have completed configuring the **Map Gateway Settings**.

**Map Gateway Setting**

Configure system-wide settings of the Mobile Application Part (MAP) gateway that runs on the SCG. restart.

**Traffic Mode:** Load\_Share

**Local Network Indicator:** ITU

**Local Network Indicator:** \* International ▼

Refresh Apply Cancel

**Figure 64:** The Map Gateway Settings configuration form

## MNC to NDC Mapping

The MNC (Mobile Network Code) to NDC (Network Destination Code) mapping information is required for sending and receiving MAP traffic. This information is used by all the HLR services that have been created.

This section covers:

### Adding MNC to NDC Mapping

Follow these steps to add a new MNC (Mobile Network Code) to NDC (Network Destination Code) mapping.

**NOTE:** Before you can add an MNC to NDC mapping, you must first enable the Map Gateway. See [Map Gateway Settings](#) for more information.

1. Go to **Configuration > Services & Profiles**.
2. On the sidebar under **Services**, click **HLR**.
3. Click **MNC to NDC Mappings** on the sidebar under **HLR**.

The **MNC to NDC Mapping** page appears.



4. Click **Create New**.
5. Define the MNC to NDC mapping by filling out the following boxes.
  - **MCC**: Type the mobile country code digits. Decimal digit strings with maximum length of 3 and minimum length of 2.
  - **MNC**: Type the mobile network code digits. Decimal digit strings with maximum length of 3 and minimum length of 2.
  - **NDC**: Type the network destination code digits, which has a maximum length of 5 digits.
6. Click **Save**.
7. To add another mapping, repeat steps 4 to 6.
8. Click **Apply**.

You have completed adding an MNC to NDC mapping.

<input checked="" type="checkbox"/>	MCC	MNC	NDC	Actions
	<input type="text"/>	<input type="text"/>	<input type="text"/>	

**Figure 65: Adding an MNC to NDC mapping**

### Viewing MNC to NDC Mapping

Follow these steps to view a list of mapping information.

1. Go to **Configuration > Services & Profiles**.
2. On the sidebar under **Services**, click **HLR**.
3. Click **MNC to NDC Mappings** on the sidebar under **HLR**.

The **MNC to NDC Mapping** page appears and lists the MNC to NDC mappings that you have created. For each mapping on the list, the following details are displayed:

- MCC
- MNC
- NDC
- Actions: Displays the trash bin icon, which you can click to delete the mapping

You have completed viewing a list of existing MNC to NDC mappings.

**MNC to NDC Mapping**

This table defines the MNC to NDC mapping information necessary to send/receive MAP traffic. This mapping information is used by all of the HLR services that have been defined.

<input type="checkbox"/> MDC	MNC	NDC	Actions
<input type="checkbox"/> 404	68	98	
<input type="checkbox"/> 070	012	98	

**Figure 66: The MNC to NDC Mapping page displays the mappings that you have created**

### Deleting MNC to NDC Mappings

Follow these steps to delete a single or multiple mappings simultaneously.

1. Go to **Configuration > Services & Profiles**.
2. On the sidebar under **Services**, click **HLR**.

The **HLR** submenu appears.

3. Click **MNC to NDC Mappings**.

4. Delete a single mapping or multiple mappings.

5. To delete a single mapping:

- a) From the list of existing mappings, locate the mapping that you want to delete.
- b) Under the **Actions** column, click the icon that is in the same row as the mapping.

A confirmation message appears.

- c) Click **Yes**.

The page refreshes, and the mapping that you deleted disappears from the view list.

6. To delete multiple mappings simultaneously, follow these steps:

- a) From the list of existing mappings, locate the mappings that you want to delete.
- b) Select the check boxes before the mappings that you want delete.
- c) Click **Delete Selected**.

A confirmation message appears.

- d) Click **Yes**.

The page refreshes and the mappings that you deleted disappears from the list.

You have completed deleting **MNC to NDC mappings**.

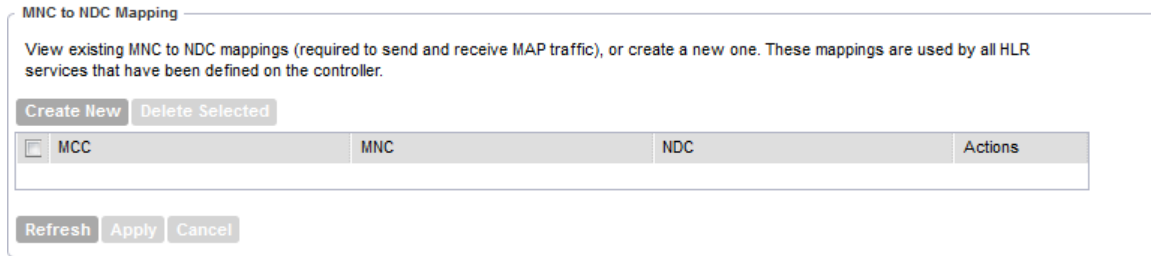


Figure 67: Deleting multiple MNC to NDC mappings simultaneously

## Configuring Diameter Services

The controller supports the 3GPP STa interface for EAP-SIM to authenticate and authorize subscribers.

### Configuring System Wide Settings

Follow these steps to configure the system wide Diameter service settings.

1. Go to **Configuration > Services & Profiles**.
2. On the sidebar, click **System Wide Settings** under **Diameter Services**.
3. In the **System Wide Settings** section, configure the following options:
  - **Local Host Name**
  - **Local Realm Name**
  - **Peer Retry Timeout** (in seconds)
  - **Connection Retry Timeout** (in seconds)
  - **Device Watchdog Timeout** (in seconds)
4. Click **Apply**.

You have completed configuring the system wide settings for Diameter services.

#### System Wide Settings

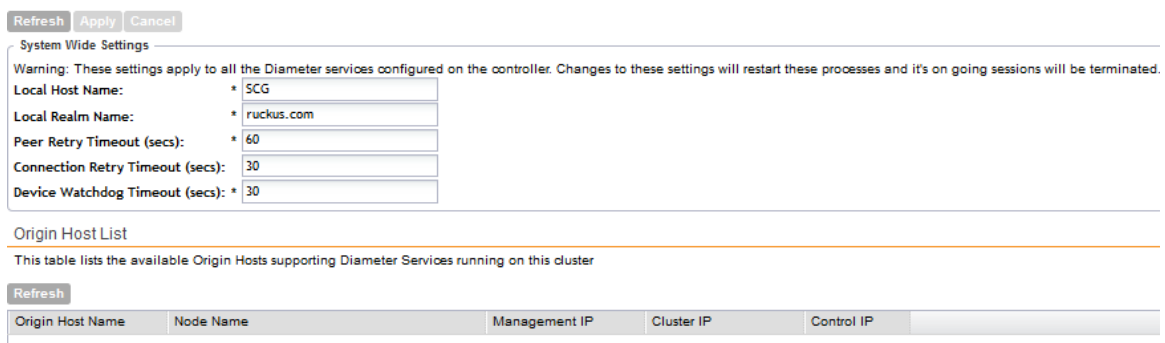


Figure 68: The System Wide Settings page

## Configuring Remote Peer Settings

The controller supports the 3GPP STa interface for EAP-SIM to authenticate and authorize subscribers.

Follow these steps to configure the remote peer settings for the Diameter services.

1. Go to **Configuration > Services & Profiles**.
2. On the sidebar, click **Remote Peer Configuration** under **Diameter Services**.

The **Remote Diameter Services** page appears.

3. Click **Create New**.

The **Create Remote Diameter Peer Configuration** form appears.

4. In **Service Name**, type a name for the service you are creating.
5. In **Description**, type a brief description of the service.
6. In **General Settings**, configure the following options:
  - **Server Realm Name**: Type name realm name of the server.
  - **Service Type**: Select the type of Diameter service. Options include:
    - **DRA** (Diameter Routing Agents)
    - **OCS** (Online Charging Systems)
    - **PCRF** (Policy and Charging Rules Functions)
    - **STA**

If you select **PCRF** or **STA**, you will need to configure the **Tx Timer** (in seconds) and **Retransmit Count** settings as well.

7. In **Peers**, add a peer entity to associate with the current Diameter remote peer settings by filling out the following boxes:
  - **Peer Name**
  - **IP Address**
  - **Port**
  - **Transport Type**
  - **Alternate Peer > r**
  - a) Click **Save** to add this peer entity to the remote peer settings.
  - b) To add another peer entity, click **Create New** in the **Peers** section, and then fill out the new set of boxes that appear.
8. Click **Create New** at the bottom of the page to create the remote peer configuration.

You have completed configuring the remote peer settings for the Diameter services.

**Create Diameter Remote Peer Configuration**

Service Name: \*

Description:

General Settings

Server Realm Name: \*

Service Type: \* No data available ▼

Peers

This table lists all the peer entities associated with the current Diameter Remote Peer configuration

<input type="checkbox"/>	Peer Name	IP Address	Port	Transport Type	Alternate Peer	Actions

Figure 69: The Create Diameter Remote Peer Configuration form

## Configuring FTP Services

You can automatically back up statistical data, CGF server binary files, reports, and system configuration backups to an external FTP server. However, before you can do this, you must add at least one FTP server to the controller. Follow these steps to add an FTP server to which the controller will export data automatically.

1. Go to **Configuration > Services & Profiles**.
2. On the sidebar under Services, click FTP.  
The **FTP** page appears.
3. In **FTP Name**, type a name that you want to assign to the FTP server that you are adding.
4. In **Port**, type the FTP port number. The default FTP port number is 21.
5. In **FTP Host**, type the IP address of the FTP server.
6. In **User Name**, type user name of the FTP account that you want to use.
7. In **Password**, type the password that is associated with the FTP user name above.
8. In **Remote Directory**, type the path on the remote FTP server to which data will be exported from the controller. The path must start with a forward slash (/).
9. To verify that the FTP server settings and logon information are correct, click **Test**.

If the server and logon settings are correct, the following message appears: `Test completed successfully.`

10. Click **Create New**.

You have completed adding an FTP server to the controller. You may add additional FTP servers as required.

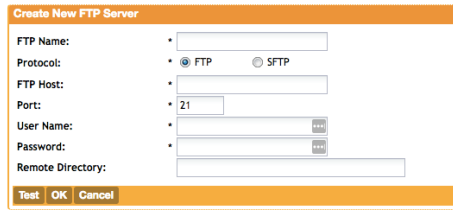


Figure 70: Adding an FTP server to the controller

### Important Notes When Adding FTP Servers

If you are adding an FTP server to the controller, take note of these changes that were made in later releases.

Remember the following important notes when configuring FTP services in release 2.5 (and later).

- Duplicate FTP servers are not allowed in release 2.5 (and later). For example, you cannot add 172.19.7.23 as one FTP server and 172.19.7.23/temp (/temp is the remote directory) as another.

**NOTE:** /temp refers to /home, /admin or /temp in that server. If /temp does not follow the server IP address (such as 172.19.7.23/temp), it indicates that the FTP directory is /home or /admin. Here, *admin* refers to the username that is configured in the new FTP server.

- FTP servers must be added on the **Configuration > Services & Profiles > FTP** page. The FTP servers that you add on this page will appear as options on the following pages:
  - **Configuration > Services & Profiles > Services > CGF services > Auto Export FTP > Binary File Options**
  - **System > FTP Server for Uploading Statistics**
  - **Reports > Export Report Results**
  - **System Configuration Backup and Restore > Auto Export Backup**
- If, before the controller was upgraded to 2.5 (or later version), statistics upload, CGF server binary files, reports, and system configuration backup were configured to be uploaded to four different FTP servers, then after upgrading to 2.5 (or later version), the controller will automatically create entries for those four FTP servers on the **Configuration > Services & Profiles > FTP** page.

- If, before the controller was upgraded to 2.5, statistics upload, CGF server binary files, reports, and system configuration backup were configured to be uploaded to the same FTP server but using different FTP accounts, then after upgrading to 2.5 or later version, the controller will automatically create entries for those four FTP servers on the **Configuration > Services & Profiles > FTP** page.
- If, before the controller was upgraded to 2.5 (or later version), statistics upload, CGF server binary files, reports, and system configuration backup were configured to be uploaded to the same FTP server and using the same FTP account, then after upgrading to 2.5 (or later version), the controller will automatically create one FTP server entry on the **Configuration > Services & Profiles > FTP** page. If one of the previous FTP server configurations included a remote directory, the same remote directory will be applied to the new FTP server entry and all data for backup will be uploaded to this remote directory.
- In previous builds, the remote directory option was available for the CGF server binary files and reports. Statistics and system configuration backups did not have the remote directory option.

## Configuring Location Services

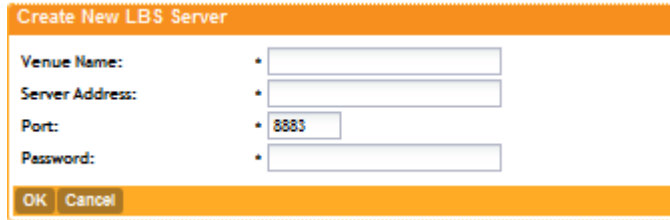
If your organization purchased the Ruckus Wireless SmartPositioning Technology (SPoT) location service, the controller must be configured with the venue information that is displayed in the SPoT Administration Portal. After completing purchase of the SPoT location service, you will be given account login information that you can use to log into the SPoT Administration Portal. The Admin Portal provides tools for configuring and managing all of your “venues” (the physical locations in which SPoT service is deployed). After a venue is successfully set up, you will need to enter the same venue information on the controller.

### Adding an LBS Server

Follow these steps to add an LBS server to the controller for SPoT communication.

1. Log on to the **SPoT Administration Portal**.
2. On the **Venues** page, click **Config** next to the venue for which you want to configure Location services.
3. In **Controller Settings**, take note of the values for the following:
  - **Venue Name**
  - **Server Address**
  - **Port**
  - **Password**
4. On the controller web interface, go to **Configuration > Services & Profiles > Services > Location Services**.
5. Click **Create New**.

The **Create New LBS Server** form appears.



The screenshot shows a dialog box titled "Create New LBS Server". It features an orange header bar with the title and an orange footer bar with "OK" and "Cancel" buttons. The main area contains four labeled input fields, each with a small asterisk icon to its left: "Venue Name:", "Server Address:", "Port:" (with the value "8883" entered), and "Password:". The fields are white with thin grey borders.

Figure 71: The Create New LBS Server form

6. Enter the information you obtained in Step 3 from the SPoT Administration Portal into the four fields provided.

- **Venue Name**
- **Server Address**
- **Port**
- **Password**

7. Click **OK** to save your changes.

You have completed adding an LBS server to the controller. You can now use this LBS server along with your zone and AP group configuration (see [Configuring the Controller to Use the LBS Server](#)).

After you configure zones or AP groups to use an LBS server, you can

### Configuring the Controller to Use the LBS Server

There are two ways to configure the controller to use the LBS servers you added in [Adding an LBS Server](#). You can:

- Set an entire AP zone to use an LBS server
- Set an AP group to override the LBS settings of a zone

**NOTE:** For information on configuring and managing the Ruckus Wireless SmartPositioning Technology (SPoT) service, refer to the SPoT User Guide, which is available for download from <https://support.ruckuswireless.com>.



## Setting an AP Zone to Use an LBS Server

When you create or edit an AP zone, you can enable the LBS service for the entire zone by selecting the Enable LBS service check box, and then selecting an LBS server to use.

The screenshot shows a configuration form for an AP zone. The 'Location Based Service' section is highlighted with a red box. It contains the following settings:

- Client Load Balancing:** Balances the number of clients across adjacent APs.
  - Run load balancing on 2.4GHz radio Adjacent Radio Threshold (dB) 50
  - Run load balancing on 5GHz radio Adjacent Radio Threshold (dB) -43
- Band Balancing:**
  - Enable band balancing on radios by distributing the clients on 2.4G and 5G bands.
  - Percentage of client load on 2.4G Band: 25%
- Location Based Service:**
  - Enable LBS Service
  - test-lbs-server1 (selected in dropdown)
- Client Admission Control:**
  - 2.4GHz Radio:**
    - Enable
    - Min Client Count: test-lbs-server1
    - Max Radio Load: test-lbs-server2
    - Min Client Throughput: 0 Mbps
- AP Reboot Timeout:**
  - Reboot AP if it cannot reach default gateway after : \* 30 minutes
  - Reboot AP if it cannot reach SCG after : \* 2 hours

Buttons for 'OK' and 'Cancel' are at the bottom.

Figure 72: Enabling and selecting an LBS in the create/edit AP zone form

## Setting an AP Group to Override the LBS Settings of a Zone

If you want APs that belong to an AP group to use a different LBS server, you can override the LBS settings at the AP group level. Follow these steps.

1. Go to **Configuration > AP Zones**.
2. In the **AP Zone List**, click the zone name to which the AP group you want to configure belongs.
3. On the sidebar, click **AP Group**.
4. Click **Create New** to create a new AP group, or click the AP group name to edit it.
5. In the form that appears, scroll down to the **Advanced Options** section. Click the plus (+) sign before **Advanced Options** to display all options.
6. In **Location Based Service**, select the **Override zone config** check box.
7. Configure the LBS settings as required.
  - To disable the LBS service for this AP group, clear the **Enable LBS service** check box.
  - To use a different LBS server for this AP group, select the **Enable LBS service** check box, and then select the LBS server that you want to use from the drop-down list.
8. Configure the other AP group settings as required.

For information on configuring AP groups, see [Creating an AP Group](#) on page 45.

9. Click **OK**.

You have completed setting an AP group to override the LBS settings of its zone.

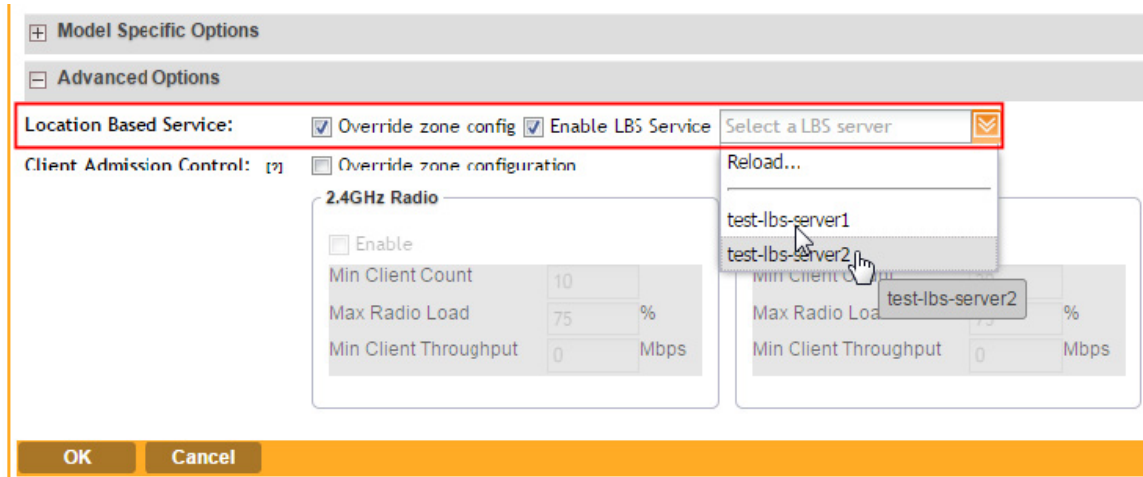


Figure 73: Overriding the LBS settings of a zone at the AP group level

## Configuring an SMS Server

If you want to deliver guest passes to guest users via SMS, you can configure the controller use an existing Twilio account for SMS delivery.

The first step is to inform the controller of your Twilio account information.

Follow these steps to configure an external SMS gateway for the controller.

1. Go to **Configuration > Services & Profiles > SMS Server**.
2. Select the **Enable Twilio SMS Server** check box.
3. Under **Twilio Account Information**, configure the following:
  - **Server Name**
  - **Account SID**
  - **Auth Token**SCG
  - **From** (phone number)
4. Click **Apply**.

You have completed configuring the external SMS gateway for the controller.

Twilio SMS Server Settings

Define the external SMS gateway services used to distribute guest pass credentials to guests.

Enable Twilio SMS Server

Twilio Account Information

Server Name: \*

Account SID: \*

Auth Token: \*

From: \*

Refresh Apply Cancel

Figure 74: Configuring the external SMS gateway settings

## Working with Profiles

This section covers:

### Working with Authentication Profiles

An authentication profile defines the authentication policy when the controller is used as a RADIUS proxy service for WLANs. RADIUS protocol is used for interfacing between access points and the controller as well as between the controller and a third party AAA server.

The controller acts as RADIUS proxy for authentication and authorization and as a RADIUS client for accounting.

This section covers:

#### Creating an Authentication Profile

An authentication profile defines the authentication policy when the controller is used as a Radius proxy service for WLANs.

Follow these steps to create an authentication profile.

1. Go to **Configuration > Services & Profiles**.
2. On the sidebar under **Profiles**, click **Authentication**.

The **Authentication Profiles** page appears.

3. Click **Create New**.

The **Create New Authentication Profile** form appears.

4. In **Name**, type a name for the authentication profile that you are adding.
5. In **Description**, type a brief description of the profile.

This is an optional field.

6. To enable hosted AAA support, select the **Enable Hosted AAA Support** check box, and then configure the options under **Hosted AAA Server RADIUS Settings** and **PLMN Settings**.
  - a) Under **Hosted AAA Server RADIUS Settings**:

- **Interim Accounting Interval (secs):** Set the interim time interval for RADIUS clients to send accounting updates. Default is 0, which indicates that the accounting interval is disabled.
- **Sessions Timeout (secs):** Set a time limit after which users will be disconnected and required to log on again.
- **Session Idle Timeout (secs):** Set a value in seconds (60 to 600) after which idle clients will be disconnected.

b) Under **PLMN ID Settings:**

- **Mobile Country Code:** Set the correct country code for the geographical location. This is required when the controller sends MAP authentication information to the HLR.
- **Mobile Network Code:** Set the mobile network code based on the geographical location. This is required when the controller sends MAP authentication information to HLR.

7. Under **Realm Based Authentication Service**, configure the following attributes, which are required for enabling AAA support. These are also required when controller authentication works as a proxy.

- Click **No Match**, and configure the following:
  - **Default Auth Service**
  - **Authorization Method**
  - **Dynamic VLAN ID**
- Click **Unspecified**, and then configure the following:
  - **Default Auth Service:** If you select **NA-Request Rejected**, then the authorization method will be displayed as 'NA' but the value that will be sent is 0 (zero).
  - **Authorization Method**
  - **Dynamic VLAN ID**

8. In **Authentication Service Per Realm**, specify the authentication service for each of the realms specified in this table. If you set the authentication service for a particular realm to **NA-Request Rejected**, then the authentication request is rejected. To create a new service click, **Create New**, and then configure the following:

- **Realm**
- **Auth Service**
- **Authorization Method**
- **Dynamic VLAN ID**

9. Click **Create New**.

You have completed adding an authentication profile.

Figure 75: The Create New Authentication Profile form

### Viewing Authentication Profiles

An authentication profile defines the authentication policy when the controller is used as a Radius proxy service for WLANs.

Follow these steps to view a list of authentication profiles that have been created on the controller.

**NOTE:** If you have not created an authentication profile, refer to [Creating an Authentication Profile](#).

1. Go to **Configuration > Services & Profiles**.
2. On the sidebar under **Profiles**, click **Authentication**.

The **Authentication Profiles** page appears and displays the authentication servers that have been added to the controller. For each authentication profile, the following details are displayed:

- **Profile Name**
- **Description**
- **Last Modified By**
- **Last Modified On**

- **Actions:** Displays the trash bin icon, which you can click to delete the profile

You have completed viewing a list of authentication profiles.

#### Authentication

View existing external authentication servers that can be used when authentication services are required, or create a new one. These servers are only used when an AP sends an authentication message to the controller and the controller forwards the message to external servers (proxy mode).

Name	Friendly Name	Protocol	Description	Last Modified On	Last Modified By	Actions
<input checked="" type="checkbox"/> AUTH		RADIUS		2015/10/13 14:13:20	admin	
<input type="checkbox"/> Guest		GUEST		2015/09/07 15:04:46		
<input type="checkbox"/> Local Database		LOCAL_DB		2015/09/07 15:04:46		

**Figure 76: The Authentication Profiles page lists the profiles that have been created on the controller**

#### Deleting Authentication Profiles

Follow these steps to delete a single or multiple authentication profiles simultaneously.

1. Go to **Configuration > Services & Profiles**.
2. On the sidebar under **Profiles**, click **Authentication**.

The **Authentication** page appears and lists the profiles that have been configured on the controller.

Delete a single or multiple profiles.

3. To delete a single profile:
  - a) From the list of existing profiles, locate the profile that you want to delete.
  - b) Under the **Actions** column, click the icon that is in the same row as the profile.  
A confirmation message appears.
  - c) Click **Yes**.  
The page refreshes, and the profile that you deleted disappears from the view list.
4. To delete multiple profiles simultaneously, follow these steps:
  - a) From the list of existing profiles, locate the profiles that you want to delete.
  - b) Select the check boxes before the profiles that you want delete.
  - c) Click **Delete Selected**.  
A confirmation message appears.
  - d) Click **Yes**.  
The page refreshes and the profiles that you deleted disappears from the list.

You have completed deleting authentication profiles.

## Authentication

View existing external authentication servers that can be used when authentication services are required, or create a new one. These servers are only used when an AP sends an authentication message to the controller and the controller forwards the message to external servers (proxy mode).

Refresh Create New Test AAA Delete Selected Search terms:  x Include all terms Include any of these terms

<input checked="" type="checkbox"/>	Name	Friendly Name	Protocol	Description	Last Modified On	Last Modified By	Actions
<input checked="" type="checkbox"/>	AUTH		RADIUS		2015/10/13 14:13:20	admin	
<input type="checkbox"/>	Guest		GUEST		2015/09/07 15:04:46		
<input type="checkbox"/>	Local Database		LOCAL_DB		2015/09/07 15:04:46		

Show: 20 << | 1 | >> 3 total records

Figure 77: Deleting multiple profiles simultaneously

## Working with Accounting Profiles

An accounting profile defines the accounting policy when the controller is used as a RADIUS proxy for WLAN services. This section covers:

### Creating an Accounting Profile

An accounting profile defines the accounting policy when the controller is used as a Radius proxy for WLAN services.

Follow these steps to create an accounting profile.

1. Go to **Configuration > Services & Profiles**.
2. On the sidebar under **Profiles**, click **Accounting**.

The **Accounting Profiles** page appears

3. Click **Create New**.

The **Create New Accounting Profile** form appears.

4. In **Name**, type a name for the authentication profile that you are adding.
5. In **Description**, type a brief description of the profile.

This is an optional field.

6. Under **Default Service Settings**, configure the following:

- In **No Matching Realm Found**, select a default accounting service. If you select **NA-Disabled**, then the accounting method will be displayed as NA but the value that will be sent is 0 (zero).
- In **No Realm Specified**, select a default accounting service. If you select **NA-Disabled**, then the accounting method will be displayed as NA but the value that will be sent is 0 (zero).

7. In **Accounting Service Per Realm**, specify the accounting service for each of the realms specified in this table. If you set the accounting service for a particular realm to NA-Disabled, then the accounting request is rejected. To create a new service click, **Create New**, and then configure the following:

- **Realm**
- **Accounting service**

8. Click **Create New**.

You have completed adding an accounting profile.

**Create New Accounting Profile**

Name: \*

Description:

Accounting Service Per Realm

Realm \*  Accounting Service \*

Realm	Accounting Service
No Match	NA-Disabled
Unspecified	NA-Disabled

Note: A realm to service mapping define the accounting service for each of the realm specified in this table. When the accounting service for a particular realm is 'NA', then accounting is disabled.

ACC-PROF admin

**Figure 78: The Create New Accounting Profile form**

### Viewing Accounting Profiles

An accounting profile defines the accounting policy when the controller is used as a Radius proxy for WLAN services.

Follow these steps to view a list of accounting profiles that have been created on the controller.

**NOTE:** If you have not created an accounting profile, refer to [Creating an Accounting Profile](#).

1. Go to **Configuration > Services & Profiles**.
2. On the sidebar under **Profiles**, click **Accounting**.

The **Accounting Profiles** page appears and displays the accounting profiles that have been added to the controller. For each accounting profile, the following details are displayed:

- **Profile Name**
- **Description**
- **Last Modified By**
- **Last Modified On**
- **Actions:** Displays the **trash bin** and **clone** icons. Click the **trash bin** icon to delete the profile. Click the **clone** icon to create a copy of the profile.

You have completed viewing a list of accounting profiles.

Accounting

View existing external accounting servers that can be used when accounting services are required, or create a new one. These servers are only used when an AP sends an accounting message to the controller and the controller forwards the message to external servers (proxy mode).

Refresh Create New Test AAA Delete Selected Search terms:   Include all terms  Include any of these terms

<input checked="" type="checkbox"/> Name ▲	Protocol	Description	Last Modified On	Last Modified By	Actions
<input checked="" type="checkbox"/> ACC	RADIUS		2015/10/08 11:45:58	admin	

Show  << | 1 | >> 1 total records

**Figure 79: The Accounting Profiles page lists the profiles that have been created on the controller**



## Deleting Accounting Profiles

Follow these steps to delete a single or multiple accounting profiles simultaneously.

1. Go to **Configuration > Services & Profiles**.

2. On the sidebar under **Profiles**, click **Accounting**.

The **Accounting** page appears and lists the profiles that have been configured on the controller.

3. Delete a single or multiple profiles.

To delete a single profile:

4. From the list of existing profiles, locate the profile that you want to delete.

5. Under the **Actions** column, click the icon  that is in the same row as the profile.

A confirmation message appears.

6. Click **Yes**.

The page refreshes, and the profile that you deleted disappears from the view list.

To delete multiple profiles simultaneously, follow these steps:

7. From the list of existing profiles, locate the profiles that you want to delete.

8. Select the check boxes before the profiles that you want delete.

9. Click **Delete Selected**.

A confirmation message appears.

10. Click **Yes**.

The page refreshes and the profiles that you deleted disappears from the list.

You have completed deleting accounting profiles.

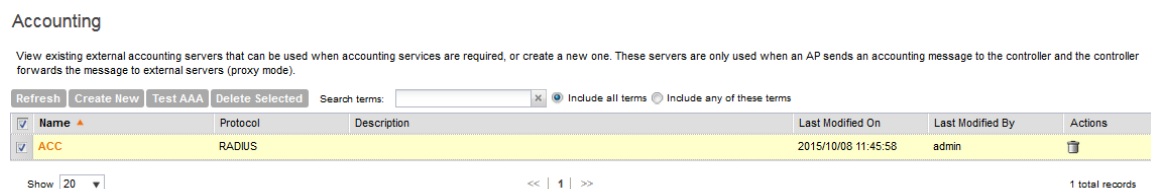


Figure 80: Deleting multiple profiles simultaneously

## Working with Hotspot Profiles

A hotspot profile defines the hotspot configuration that will be used for 3rd party AP zones. This section covers:

### Creating a Hotspot Profile

A hotspot profile defines the hotspot configuration used for 3rd party AP zones.

Follow these steps to create a hotspot profile.

1. Go to **Configuration > Services & Profiles**.

2. On the sidebar under **Profiles**, click **Hotspot**.

The **Hotspot Profiles** page appears.

3. Click **Create New**.

The **Create New Hotspot Profile** form appears.

4. In the **General Options** section, configure the following options:

- **Name:** Type a name for the WISPr service.
- **Description:** Type a description for the WISPr service.

5. Configure the options in the **Redirection** section.

- a) In **Smart Client Support**, select one of the following options:

- **None:** Select this option to disable Smart Client support in this hotspot.
- **Enable:** Selection this option to enable Smart Client support.
- **Only Smart Client Allowed:** Select this option to allow only Smart Clients to connect to the hotspot. For more information, see [Configuring Smart Client Support](#) on page 279.

- b) In **Logon URL**, type the URL of the subscriber portal (the page where hotspot users can log on to access the hotspot portal).

For more information, see [Configuring the Hotspot Logon URL](#) on page 279.

- c) In **Start Page**, set where users will be redirected after they log in successfully:

- **Redirect to the URL that user intends to visit:** You could redirect users to the page that they want to visit.
- **Redirect to the following URL:** You could set a different page where users will be redirected (for example, your company website).

6. In the **User Session** section, configure the following options:

- **Session Timeout:** Set a time limit (in minutes) after which users will be disconnected from the hotspot portal and will be required to log on again.
- **Grace Period:** Set the time period (in minutes) during which disconnected users are allowed access to the hotspot portal without having to log on again.

7. In the **Location Information** section, configure the following options:

- a) **Location ID:** Type the ISO and ITU country and area code that the AP includes in accounting and authentication requests.

The required code includes:

- **isocc (ISO-country-code):** The ISO country code that the AP includes in RADIUS authentication and accounting requests.
- **cc (country-code):** The ITU country code that the AP includes in RADIUS authentication and accounting requests.
- **ac (area-code):** The ITU area code that the AP includes in RADIUS authentication and accounting requests.
- network

The following is an example of what the Location ID entry should look like:

```
isocc=us,cc=1,ac=408,network=RuckusWireless
```

b) **Location Name:** Type the name of the location of the WISPr service.

8. In **Walled Garden**, click **Create New** to add a walled garden.

A walled garden is a limited environment to which an unauthenticated user is given access for the purpose of setting up an account.

9. In the box provided, type a URL or IP address to which you want to grant unauthenticated users access.

You can add up to 128 network destinations to the walled garden. Network destinations can be any of the following:

- IP address (for example, 10.11.12.13)
- IP address range (for example, 10.11.12.13-10.11.12.15)
- Classless Inter-Domain Routing or CIDR (for example, 10.11.12.100/28)
- IP address and mask (for example, 10.11.12.13 255.255.255.0)
- Exact website (for example, www.ruckuswireless.com)
- Website with special regular expression like
  - \*.amazon.com
  - \*.com
  - \*

After the account is established, the user is allowed out of the walled garden. URLs will be resolved to IP addresses. Users will not be able to click through to other URLs that may be presented on a page if that page is hosted on a server with a different IP address. Avoid using common URLs that are translated into many IP addresses (such as www.yahoo.com), as users may be redirected to re-authenticate when they navigate through the page.

10. Click **Create New**.

You have completed creating a hotspot profile for 3rd party AP zones.

Figure 81: The Create New Hotspot Profile form

### Viewing Hotspot Profiles

A hotspot profile defines the hotspot configuration that will be used for 3rd party AP zones. Follow these steps to view a list of hotspot profiles that have been created on the controller.

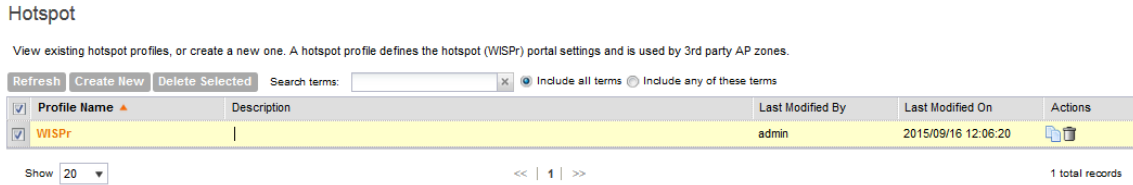
**NOTE:** If you have not created a hotspot profile, refer to [Creating a Hotspot Profile](#).

1. Go to **Configuration > Services & Profiles**.
2. On the sidebar under **Profiles**, click **Hotspot**.

The **Hotspot Profiles** page appears and displays the hotspot profiles that you have create. For each hotspot profile, the following details are displayed:

- **Profile Name**
- **Description**
- **Last Modified By**
- **Last Modified On**
- **Actions:** Displays the **trash bin** and **clone** icons. Click the **trash bin** icon to delete the profile. Click the **clone** icon to create a copy of the profile.

You have completed viewing a list of hotspot profiles.



**Figure 82: The Hotspot Profiles page lists the profiles that have been created on the controller**

### Deleting Hotspot Profiles

Follow these steps to delete a single or multiple accounting profiles simultaneously.

1. Go to **Configuration > Services & Profiles**.
2. On the sidebar under **Profiles**, click **Hotspot**.

The **Hotspot** page appears and lists the profiles that have been configured on the controller.

Delete a single or multiple profiles.

3. To delete a single profile:
  - a) From the list of existing profiles, locate the profile that you want to delete.
  - b) Under the **Actions** column, click the icon that is in the same row as the profile.
  - c) A confirmation message appears.
  - d) Click **Yes**.

The page refreshes, and the profile that you deleted disappears from the view list.

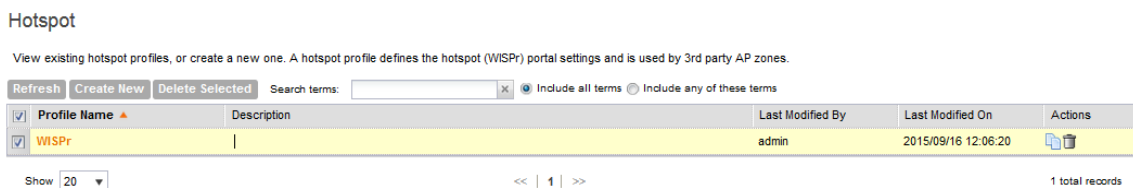
4. To delete multiple profiles simultaneously, follow these steps:
  - a) From the list of existing profiles, locate the profiles that you want to delete.
  - b) Select the check boxes before the profiles that you want delete.
  - c) Click **Delete Selected**.

A confirmation message appears.

- d) Click **Yes**.

The page refreshes and the profiles that you deleted disappears from the list.

You have completed deleting hotspot profiles.



**Figure 83: Deleting multiple profiles simultaneously**

## Working with Network Traffic Profiles

A network traffic profile defines per AP rate limits and the access control list (ACL) rules that apply to that AP.

Only super administrators have the privilege to configure network traffic profiles. MVNOs cannot view, create, edit, or delete network profiles.

Each 3rd party AP zone is required to have one network traffic profile. The controller provides a factory default network traffic profile, which is associated with a zone if an alternative is not specified while creating a new zone. The controller allows super administrators to set the default profile to a customized network traffic profile. The factory default network traffic profile is defined as no rate limits and allows all traffic.

### Creating a Network Traffic Profile

A network traffic profile defines per AP rate limits and the access control list (ACL) rules that apply to that AP.

Follow these steps to create a network traffic profile.

1. Go to **Configuration > Services & Profiles**.
2. On the sidebar under **Profiles**, click **Network Traffic**.  
The **Network Traffic Profiles** page appears and displays the default network traffic profile named **SCG Factory Default**.
3. Click **Create New**.  
The **Create New Network Traffic Profile** form appears.
4. In **Name**, type a name for the profile that you are creating.
5. In **Description**, type a brief description of the profile.  
This is an optional field.
6. In **Default Options**, set the **Default Traffic Handling Action** to either **Allow** or **Block**.  
The default setting is **Allow**.
7. In **Network Access Control List**, click **Create New** to add a network access control list, and then configure the following options:
  - a) **Source IP Range**: Type an IP address to assign to this profile, as well as a subnet mask for the IP address. This is the IP address range that will be allowed access to the network traffic profile.
  - b) **Source Port Range**: Type a port number.  
To specify a range of port numbers, select the **Range** check box, and then set the starting port number and ending port number in the first and second boxes, respectively.
  - c) **Destination IP Range**: Type the destination IP address to assign to this profile, as well as a subnet mask for the IP address.  
This is the IP address range that will be allowed to send traffic using this network traffic profile.
  - d) **Destination Port Range**: Type a port number.  
To specify a range of port numbers, select the **Range** check box, and then set the starting port number and ending port number in the first and second boxes, respectively.
  - e) **Protocol**: Select the protocol that you want to allow or deny. If you cannot find the protocol name, type the protocol number.

f) **Direction:** Select the traffic direction to which this profile will be applied.  
Options include **Upstream** and **Downstream** (default). This setting will limit the rate at which WLAN clients can upload or download data.

8. In **Traffic Handling Action**, set the action to apply to the traffic.

Options include **Block** and **Allow**.

9. Click **Create New**.

You have completed creating a network traffic profile.

The screenshot shows a web form titled "Create New Network Traffic Profile". The form includes the following elements:

- Name:** A required text input field (indicated by an asterisk).
- Description:** A text input field.
- Default Options:** A section containing a dropdown menu for "Default Traffic Handling Action:" with "Allow" selected. This field is also marked as required with an asterisk.
- Network Access Control List:** A section containing a table with two columns: "Priority" and "Matching Criteria".
- Buttons:** "Create New" and "Delete Selected" buttons are located below the table.
- Footer:** "OK" and "Cancel" buttons are located at the bottom of the form in an orange bar.

Figure 84: The Create New Network Traffic Profile form

### Viewing Network Traffic Profiles

A network traffic profile defines per AP rate limits and the access control list (ACL) rules that apply to that AP.

Follow these steps to view a list of network traffic profiles that have been created on the controller.

**NOTE:** If you have not created a network traffic profile, refer to [Creating a Network Traffic Profile](#).

1. Go to **Configuration > Services & Profiles**.
2. On the sidebar under **Profiles**, click **Network Traffic**.

The **Network Traffic Profiles** page appears and displays the hotspot profiles that you have create. For each network traffic profile, the following details are displayed:

- **Profile Name**
- **Description**
- **Default Action**
- **Last Modified By**
- **Last Modified On**
- **Actions:** Displays the **trash bin** and **clone** icons. Click the **trash bin** icon to delete the profile. Click the **clone** icon to create a copy of the profile.

You have completed viewing a list of network traffic profiles.

## Network Traffic

View existing network traffic profiles, or create a new one. A network traffic profile defines the access control list for 3rd party APs.

Default Network Traffic Profile: \* Factory Default

Refresh Create New Delete Selected Search terms:  Include all terms Include any of these terms

Name	Description	Default Action	Last Modified By
Factory Default	The default NTP package	Allow	admin

Show 200 << | 1 | >>

**Figure 85: The Network Traffic Profiles page lists the profiles that have been created on the controller**

### Deleting Network Traffic Profiles

Follow these steps to delete a single or multiple network traffic profiles simultaneously.


1. Go to **Configuration > Services & Profiles**.

2. On the sidebar under **Profiles**, click **Network Traffic**.

The **Network Traffic** page appears and lists the profiles that have been configured on the controller.

Delete a single or multiple profiles.

3. To delete a single profile:

- From the list of existing profiles, locate the profile that you want to delete.
- Under the **Actions** column, click the icon  that is in the same row as the profile. A confirmation message appears.
- Click **Yes**. The page refreshes, and the profile that you deleted disappears from the view list.

4. To delete multiple profiles simultaneously, follow these steps:

- From the list of existing profiles, locate the profiles that you want to delete.
- Select the check boxes before the profiles that you want delete.
- Click **Delete Selected**. A confirmation message appears.
- Click **Yes**. The page refreshes and the profiles that you deleted disappears from the list.

You have completed deleting network traffic profiles.

## Network Traffic

View existing network traffic profiles, or create a new one. A network traffic profile defines the access control list for 3rd party APs.

Default Network Traffic Profile: \* Factory Default

Refresh Create New **Delete Selected** Search terms:  Include all terms Include any of these terms

Name	Description	Default Action	Last Modified By	Last Modified On	Actions
Factory Default	The default NTP package	Allow	admin	2015/09/07 15:04:32	

Show 200 << | 1 | >> 1 total records

**Figure 86: Deleting multiple profiles simultaneously**



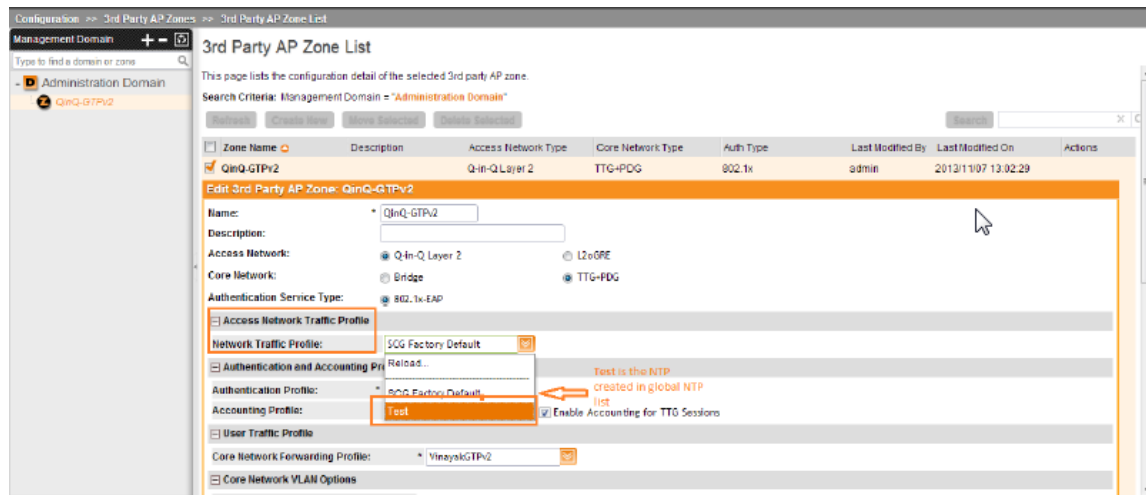
## Applying a Network Traffic Profile to a 3<sup>rd</sup> Party AP Zone

Follow these steps to apply a network traffic profile to a 3rd party AP zone.

**NOTE:** Before continuing, make sure you have already created a network traffic profile. If you have not, see [Creating a Network Traffic Profile](#) for instructions.

1. Go to **Configuration > 3rd Party AP Zones > 3rd Party AP Zone List**.
2. Under **Administration Domain**, click the 3rd party AP zone to which you want to assign a network traffic profile.  
The **Edit 3rd Party AP Zone: {zone-name}** form appears.
3. In **Access Network Traffic Profile**, select the network traffic profile that you want to assign to the 3rd party AP zone.
4. Click **Apply**.

You have completed applying a network traffic profile to a 3rd party AP zone.



**Figure 87:** In Access Network Traffic Profile, select the profile that you want to assign to the 3rd party AP zone

## Working with User Traffic Profiles

A user traffic profile defines whether the system will allow or block a particular type of traffic based on a number of attributes, including:

- Source IP address (specific IP address or IP address range)
- Source port number (specific port or port range)
- Destination IP address (specific IP address or IP address range)
- Destination port number (specific port or port range)
- Network protocol (TCP, UDP, etc.)
- Traffic direction

## Creating a User Traffic Profile

A user traffic profile defines whether the system will allow or block a particular type of traffic based on a number of attributes.

Follow these steps to create a user traffic profile.

**1. Go to Configuration > Services & Profiles > Profiles > User Traffic.**

The **User Traffic** page appears.

**2. Click Create New.**

The **Create New User Traffic Profile** page appears.

**3. In Name,** type a name for this profile.

**4. In Description,** type a short description for this profile.

**5. In Rate Limiting,** select the **Enable** check-box to enable uplink and downlink, and type the limiting rate for them.

**6. In Default Access,** select whether you want the controller to allow or block users using this profile if the user traffic does not match any of the rules you defined.

**7. In the Rules section,** click **Create New.**

**NOTE:** By default, two default rules exist (Allow DNS and Allow DHCP) when you create a new profile. You can modify these rules or even delete them.

**8. In Source IP,** specify the source IP address to which this rule will apply.

a) To apply this rule to an IP address range, type the network address and the subnet mask.

b) To apply this rule to a single IP, clear the **Subnet** check box, and then enter the IP address.

**9. In Source Port,** specify the source port to which this rule will apply.

a) To apply this rule to a port range, type the starting and ending port numbers in the two boxes.

b) To apply this rule to a single port number, clear the **Range** check box, and then enter the port number.

**10. In Destination IP,** specify the destination IP address to which this rule will apply.

a) To apply this rule to an IP address range, type the network address and the subnet mask.

b) To apply this rule to a single IP, clear the **Subnet** check box, and then enter the IP address.

**11. In Destination Port,** specify the source port to which this rule will apply.

a) To apply this rule to a port range, type the starting and ending port numbers in the two boxes.

b) To apply this rule to a single port number, clear the **Range** check box, and then enter the port number.

**12. In Protocol,** select the network protocol to which this rule will apply. Supported protocols include:

- TCP
- UDP
- UDPLITE
- ICMP (ICMPv4)
- IGMP

- ESP
- AH
- SCTP

**13** In **Direction**, leave as is.

Only one traffic direction (upstream) is supported in this release.

**14** Click **OK**.

You have completed creating a user traffic profile. The next time you a WLAN, this profile will appear as one of the options for **User Traffic Profile**.

### Viewing User Traffic Profiles

A user traffic profile defines whether the system will allow or block a particular type of traffic based on a number of attributes.

Follow these steps to view a list of existing user traffic profiles.

**1.** Go to **Configuration > Services & Profiles > Profiles > User Traffic**.

The **User Traffic Profile** page appears and displays all existing user traffic profiles and their basic settings are shown, including the:

- **User traffic profile name**
- **Description**
- **Default access (allow or block)**
- **Actions (that you can perform)**

**2.** To view the type of traffic that has been defined in a particular user traffic profile, click the profile name.

You have completed viewing existing user traffic profiles.

### Deleting Traffic Profiles

Follow these steps to delete user traffic schedule profiles.

**1.** Go to **Configuration > Services & Profiles > Profiles > User Traffic**.

The **User Traffic** page appears.

**2.** Locate the profile or profiles that you want to delete.

**3.** Select the check boxes (first column) for the profiles that you want to delete.

**4.** Click **Delete Selected**.

The profiles that you selected disappear from the list. You have completed deleting user traffic profiles.

**NOTE:** If you are deleting a single profile, you can also click the icon (under the **Actions** column) that is in the same row as the profile that you want to delete.

## Working with DNS Server Services

The DNS Server Services provides an option to override a DNS server. When the option of overriding a DNS server is enabled, the AP associated with it retrieves the DNS server configuration from the controller, and applies the configuration to the DNS server service.

### Creating a DNS Server Services Profile

The DNS server service configured for an AP allows it to retrieve the DNS server configuration.

Follow these steps to create a DNS server services profile.

1. Go to **Configuration > Services & Profiles > Service Profiles > DNS Server Services**. The **DNS Server Services** page appears.
2. Click **Create New**. The **Create DNS Server Services Profile** page appears.
3. In **Name**, type a name for this profile.
4. In **Description**, type a short description for this profile.
5. In **Primary DNS IP**, type the IP address of the primary DNS server.
6. In the **Secondary DNS IP**, type the IP address of the secondary DNS server.
7. Click **OK**.

You have completed creating a DNS server service profile.

### DNS Server Services

View existing DNS server services and their basic configuration settings, or create a new one.

The screenshot shows a web interface for creating a DNS server service profile. At the top, there are buttons for 'Refresh', 'Create New', and 'Delete Selected', along with a search bar and radio buttons for 'Include all terms' (selected) and 'Include any of these terms'. Below this is a table with columns 'Name', 'Description', and 'IP List'. An orange modal window titled 'Create DNS Server Service Profile' is open, containing the following fields: 'Name' (required), 'Description', 'Primary DNS IP' (required), and 'Secondary DNS IP'. At the bottom of the modal are 'OK' and 'Cancel' buttons.

Figure 88: Create DNS Server Services Profile form

### Viewing DNS Server Services Profiles

A DNS server services profile retrieves the configuration of the DNS server and applies it to the controller.

Follow these steps to view a list of existing DNS server services profiles.

- Go to **Configuration > Services & Profiles > Service Profiles > DNS Server Services**.

The **DNS Server Services** page appears and displays all existing DNS Server Services profiles.

### Deleting DNS Server Services Profile

Follow these steps to delete the DNS server services profiles.

1. Go to **Configuration > Services & Profiles > Service Profiles > DNS Server Services**.  
The **DNS Server Services** page appears.
2. Locate the profile or profiles that you want to delete.
3. Select the check boxes (first column) for the profiles that you want to delete.
4. Click **Delete Selected**.

The profiles that you selected disappear from the list. You have completed deleting the profiles.

### Working with Forwarding Profiles

This sections covers:

#### L2oGRE Profiles

An L2oGRE forwarding profile defines the gateway and tunnel configuration for the core network of L2oGRE tunnels. This section covers:

#### Creating an L2oGRE Profile

An L2oGRE forwarding profile defines the gateway and tunnel configuration for the core network of L2oGRE tunnels.

Follow these steps to add an L2oGRE profile.

1. Go to **Configuration > Services & Profiles**.
2. On the sidebar under **Profiles > Forwarding**, click **L2oGRE**.

The **L2oGRE Forwarding Profiles** page appears.

3. Click **Create New**.

The **Create New L2oGRE Profile** form appears.

4. In **Name**, type a name for the L2oGRE profile that you are creating.
5. In **Description**, type a brief description of the profile.

This is an optional field.

6. In **Core Network Gateway Settings**, configure the following:
  - a) **Primary Gateway IP**: Type the IP address of the primary gateway for the L2oGRE tunnel.
  - b) **Secondary Gateway IP**: Type the IP address of the secondary gateway for the L2oGRE tunnel. If the primary gateway is unreachable, this gateway will be used for the L2oGRE tunnel.
  - c) **Gateway Path MTU**: Set it the MTU manually or use **Auto** (default). MTU is the size of the largest protocol data unit (in bytes) that can be passed on the controller network.
  - d) **ICMP Keep-Alive Period (secs)**: Set the time in seconds between sending retry messages to the keepalive IP address. Enter an integer between 2 and 255. The default is 10 seconds.
  - e) **ICMP Keep-Alive Retry**: Set the retry period to send messages to the keepalive IP address. The default value is 3 retries.
7. In **DHCP Relay**, configure the following options to enable the DHCP relay agent in the controller:

- a) **Enable DHCP Relay:** Select this check box to enable the DHCP relay agent in the controller.
- b) **DHCP Server 1:** Type the IPv4 address of the DHCP server that will allocate IP addresses to DHCP clients.
- c) **DHCP Server 2:** If a secondary DHCP server exists on the network, type the IPv4 address of the secondary server.
- d) **DHCP Option 82:** Select this check box if you want the DHCP relay agent (in this case, the controller) to insert specific identification information into requests that are forwarded to the DHCP server.
- e) If you enabled **DHCP Option 82**, you can configure the following Option 82 suboptions by selecting the corresponding check boxes:
  - **Subopt-1 with format:** You can customize suboption 1 (Circuit ID) to send only the AP's MAC address in hexadecimal format or the MAC address and ESSID. The default format is: IFName:VLAN-ID:ESSID:AP-Model:AP-Name:AP-MAC
  - **Subopt 2 with format:** You can customize suboption 2 (Remote ID), which sends the client's MAC address by default, to send the AP's MAC address, or the client MAC plus ESSID or AP MAC plus ESSID.
  - **Subopt-150 with VLAN ID:** This suboption encapsulates the VLAN ID.
  - **Subopt-151 with format:** This suboption can encapsulate either the ESSID or a configurable **Area Name**.

8. Click **Create New**.

You have completed creating an L2oGRE profile.

**Create New L2oGRE Forwarding Profile**

Name: \*

Description:

Core Network Gateway Settings

Primary Gateway IP: \*

Secondary Gateway IP:

Gateway Path MTU:  Auto  Manual  bytes (850-1500)

ICMP Keep-Alive Period (secs): \*

ICMP Keep-Alive Retry: \*

DHCP Relay

Enabled DHCP Relay

DHCP Server 1: \*

DHCP Server 2:   Send DHCP requests to both servers simultaneously

DHCP Option 82:  Enable DHCP Option 82

Subopt-1 with format  ▼

Subopt-2 with format  ▼

Subopt-150 with VLAN-ID

Subopt-151 with format  ▼

**OK** **Cancel**

**Figure 89: The Create New L2oGRE Forwarding Profile form**

### About Keep-Alive Settings

The tunnel keepalive mechanism enables, extends, and implements an interface-specific command for tunnel interfaces, and provides the ability to bring down the line protocol of a tunnel. The tunnel keepalive mechanism also addresses these additional requirements:

- The tunnel keepalive mechanism functions even if the far tunnel endpoint does not support keepalives.
- The tunnel keepalive mechanism originates keepalives.
- The tunnel keepalive mechanism processes keepalives.
- The tunnel keepalive mechanism replies to keepalive packets of the far end, even when the line protocol of the tunnel is down.

### Viewing L2oGRE Profiles

Follow these steps to view a list of L2oGRE profiles that have been created.

**NOTE:** If you have not created a profile, see [Creating an L2oGRE Profile](#).

1. Go to **Configuration > Services & Profiles**.
2. On the sidebar under **Profiles > Forwarding**, click **L2oGRE**. The **L2oGRE Forwarding Profiles** page appears and displays the L2oGRE profiles that have been created.

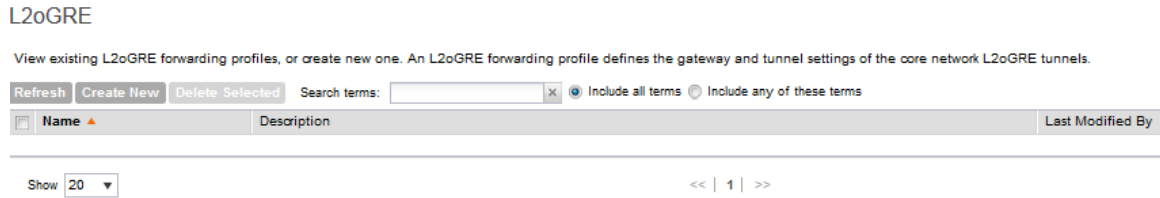



Figure 90: List view of L2oGRE Profiles

### Deleting an L2oGRE Profile

Follow these steps to delete an L2oGRE profile.

1. On the **L2oGRE Forwarding Profiles** page, locate the L2oGRE profile that you want to delete.
2. Under the **Actions** column, click the icon  that is in the same row as the L2oGRE profile name.

A confirmation message appears.

3. Click **Yes**.

The page refreshes, and the L2oGRE profile that you deleted disappears from the view list.

You have completed deleting an L2oGRE profile.

### L3oGRE Profiles

L3oGRE forwarding profile defines the gateway and tunnel configuration for core network of L3oGRE tunnels. This section covers:

#### Adding an L3oGRE Profile

L3oGRE forwarding profile defines the gateway and tunnel configuration for core network of L3oGRE tunnels.

Follow these steps to add an L3oGRE profiles.

1. On the **L3oGRE Forwarding Profiles** page, click **Create New**.

The **Create New L3oGRE profiles** form appears.

2. In **Name**, type a name for the L3oGRE profiles that you are adding.
3. In **Description**, give a brief description of the profile created.

This is an optional field.

4. In **Core Network Gateway Settings**, configure the following:

- **Core Network Gateway IP**
- **Gateway Path MTU**: Set the MTU value manually or use **Auto** (default). MTU is the size of the largest protocol data unit (in bytes) that can be passed on the controller network.

5. In **DHCP Relay Options**, configure the following:



- **DHCP Relay Service:** Select the DHCP relay service that you want to use for this L3oGRE forwarding profile. The options that appear here are the DHCP services that you created in Configuring DHCP Services.
- **DHCP Relay Through Tunnel:** Select the **Enable** check box to enable DHCP relay for tunneled traffic.

6. In the **Gateway Tunnel Settings** section, configure the following:

- **Tunnel Interface Address**
- **Tunnel Keep Alive:** Selecting the **Enable** check box enables keepalive for tunnels and allows you to configure keepalives for point-to-point GRE tunnels. The tunnel keepalive mechanism enables, extends, and implements an interface-specific command for tunnel interfaces, and delivers the ability to bring down the line protocol of a tunnel. The tunnel keepalive mechanism also addresses these additional requirements:
  - The tunnel keepalive mechanism functions even if the far tunnel endpoint does not support keepalives.
  - The tunnel keepalive mechanism originates keepalives.
  - The tunnel keepalive mechanism processes keepalives.
  - The tunnel keepalive mechanism replies to keepalive packets of the far end, even when the line protocol of the tunnel is down. You can configure keepalives with:
    - **Keep Alive Period (secs):** Specify the time in seconds between sending retry messages to the keepalive IP address. Enter an integer from 2 to 255. The default is 10.
    - **Keep Alive Retry:** Specify the retry period to send messages to the keepalive IP address. The default value is 3.

7. Click **Create New** to save the new configuration details.

You have completed adding an L3oGRE profile.

**Create New L3oGRE Forwarding Profile**

Name:

Description:

**Core Network Gateway Settings**

Core Network Gateway IP:

Gateway Path MTU:  Auto  Manual  bytes (850-1500)

**DHCP Relay Options**

Enabled DHCP Relay

DHCP Server 1:

DHCP Server 2:   Send DHCP requests to both servers simultaneously

DHCP Option 82:  Enable DHCP Option 82

Subopt-1 with format:

Subopt-2 with format:

Subopt-150 with VLAN-ID

Subopt-151 with format:

DHCP Relay Through Tunnel:  Enabled

**Gateway Tunnel Settings**

Tunnel Interface Address	Data Plane	Tunnel Interface Address	Mask
	SCG-3-2-LEAD-D1( 150.138.90.34)	<input type="text"/>	<input type="text"/>
	SCG-3-2-LEAD-D0( 150.138.90.33)	<input type="text"/>	<input type="text"/>

Tunnel Keep-Alive:  Enabled

Figure 91: Creating an L3oGRE Profile

### Viewing L3oGRE Profiles

Follow these steps to view a list of L3oGRE profiles that have been created.

1. Go to **Configuration > Services & Profiles**.
2. On the sidebar, click **Forwarding > L3oGRE**.

The **L3oGRE Forwarding Profiles** page appears, which displays the L3oGRE profiles that have been created on the controller.

If you have not created an L3oGRE profile, refer to [Adding an L3oGRE Profile](#).

### L3oGRE

View existing L3oGRE forwarding profiles, or create a new one. An L3oGRE forwarding profile defines the gateway and tunnel settings of the core network L3oGRE tunnels.

Search terms:   Include all terms  Include any of these terms


<input type="checkbox"/>	Name ▲	Description	Last Modified By

Show  << | 1 | >>

Figure 92: The L3oGRE Forwarding Profiles page lists the profiles that have been configured on the controller

### Deleting L3oGRE Profiles

Follow these steps to delete an L3oGRE profile.

1. On the **L3oGRE Forwarding Profiles** page, locate the L3oGRE profile that you want to delete.
2. Under the **Actions** column, click the icon  that is in the same row as the L3oGRE profile name.  
A confirmation message appears.
3. Click **Yes**.  
The page refreshes, and the L3oGRE profile that you deleted disappears from the view list.

You have completed deleting an L3oGRE profile.

### TTG+PDG Profiles

TTG+PDG forwarding profile defines the gateway and tunnel configurations for core network GTP tunnels and LBO configurations. This section covers:

#### Adding a TTG+PDG Profile

TTG+PDG forwarding profile defines the gateway and tunnel configurations for core network GTP tunnels and LBO configurations.

Follow these steps to add a TTG+PDG profile.

1. On the **TTG+PDG Forwarding Profiles** page, click **Create New**.  
The **Create New TTG+PDG Forwarding Profile** form appears.
2. In **Name**, type a name for the TTG+PDG Profile that you are adding.
3. In **Description**, give a brief description of the profile created.  
This is an optional field.
4. In **Common Settings**, configure the following:
  - a) **APN Format to GSN**: Select either DNS or String from the drop-down list.
  - b) **APN-OI for DNS Resolution**: Specify if the APN-OI is required.
  - c) **# of Accounting Retry**: Specify the interval (in minutes) at which the controller will recheck the primary TTG+PDG RADIUS profile, if it is available. The default interval is 5 minutes.
  - d) **Accounting Retry Timeout (secs)**: Type the timeout period (in seconds) after which an expected response message is considered to have failed.
  - e) **PDG UE Session Idle Timeout (secs)**: Type the timeout period (in seconds) after which an expected response message is considered to have failed.
5. In **DHCP Relay**, configure the following options to enable the DHCP relay agent in the controller:
  - a) **Enable DHCP Relay**: Select this check box to enable the DHCP relay agent in the controller.
  - b) **DHCP Server 1**: Type the IPv4 address of the DHCP server that will allocate IP addresses to DHCP clients.
  - c) **DHCP Server 2**: If a secondary DHCP server exists on the network, type the IPv4 address of the secondary server.
  - d) **DHCP Option 82**: Select this check box If you want the DHCP relay agent (in this case, the controller) to insert specific identification information into requests that are forwarded

to the DHCP server. If you enabled **DHCP Option 82**, you can configure the following Option 82 suboptions by selecting the corresponding check boxes:

- **Subopt-1 with format:** You can customize suboption 1 (Circuit ID) to send only the AP's MAC address in hexadecimal format or the MAC address and ESSID. The default format is: IFName:VLAN-ID:ESSID:AP-Model:AP-Name:AP-MAC
- **Subopt 2 with format:** You can customize suboption 2 (Remote ID), which sends the client's MAC address by default, to send the AP's MAC address, or the client MAC plus ESSID or AP MAC plus ESSID.
- **Subopt-150 with VLAN ID:** This suboption encapsulates the VLAN ID.
- **Subopt-151 with format:** This suboption can encapsulate either the ESSID or a configurable **Area Name**.

6. In **Forwarding Policy Per Realm**, specify the forwarding policy for each realm in the table. Configure the following:

- **APN**
- **APN Type**
- **Route Type**
- **Profile Name**

7. In **Default APN Settings**, configure the following:

- **No Matching Realm Found**
- **No Realm Specified**

8. Click **Create New**.

You have completed adding a TTG+PDG profile.

**Create New TTG+PDG Forwarding Profile**

Name:

Description:

**Common Settings**

APN Format to GGSN:

Use APN-OI for DNS Resolution:  Yes  No

# of Accounting Retry:

Accounting Retry Timeout (secs):

PDG UE Session Idle Timeout (secs):

**DHCP Relay**

Enabled DHCP Relay

DHCP Server 1:

DHCP Server 2:   Send DHCP requests to both servers simultaneously

DHCP Option 82:

Enable DHCP Option 82

Subopt-1 with format:

Subopt-2 with format:

Subopt-150 with VLAN-ID

Subopt-151 with format:

**Forwarding Policy per Realm**

This table defines the forwarding policy for each APN.

APN	APN Type	Route Type

**Default APN Settings**

Default APN when	Default APN
No Matching Realm Found	<input type="text" value="No data available"/>
No Realm Specified	<input type="text" value="No data available"/>

**Default APN per Realm**

The realm to default APN mapping defines the default APN for each of the realms specified in this table.

**Figure 93: Creating a TTG+PDG forwarding profile**

### About DHCP Relay

The controller can function as a DHCP relay agent that improves network performance by converting DHCP broadcast traffic to unicast to prevent flooding the Layer 2 network (when Layer 3 Tunnel Mode is enabled, DHCP relay only applies to Tunnel Mode WLANs.)

Typically, when mobile stations acquire IP addresses through DHCP, the DHCP request and acknowledgment traffic is broadcast to all devices in the same Layer 2 environment. With Tunnel Mode WLANs, this traffic flood is wasteful in terms of bandwidth and computing power.

When DHCP Relay is enabled in a forwarding service profile, the data plane relay agent converts DHCP Discover/Request traffic to unicast UDP packets and sends them to the DHCP servers, then delivers DHCP Offer/Ack messages from the DHCP server back to the client. The data plane adds option-82 and sends a message to the configured DHCP server. If option-82 is received from the AP, the data plane does not overwrite the configuration and sends a message to the server.

The traffic flow is as follows:

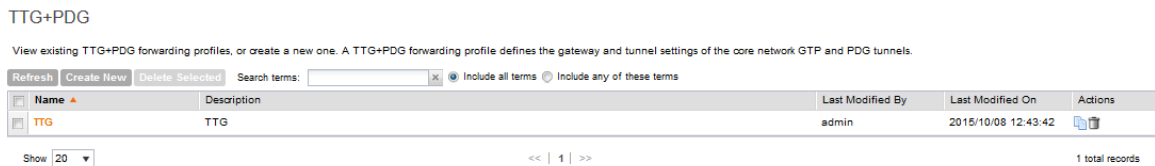
1. A client sends DHCP discover broadcast.
2. The AP tunnels this DHCP discover frame to the controller.
3. The DHCP relay agent sends unicast DHCP discover packet to the DHCP server.
4. The DHCP server sends DHCP offer to the relay agent on the controller.
5. The controller sends DHCP offer back to the AP.
6. The AP sends this DHCP offer to the client.

By reducing broadcast flooding, this option allows for higher client capacity in tunneled WLANs designed for VoIP phones, for example. It also allows for DHCP discovery across multiple subnets and limits DHCP broadcasts to client's AP tunnel and radio.

### Viewing TTG+PDG Profiles

Follow these steps to view a list of TTG+PDG Profiles defined.


1. Go to **Configuration > Services & Profiles**.
2. On the sidebar, click **Forwarding > TTG+PDG**.
3. This section displays the TTG+PDG profile that you want to use. If you have not created a server, refer to [Adding a TTG+PDG Profile](#).



**Figure 94: List view of TTG+PDG Profiles**

### Deleting TTG+PDG Profiles

Follow these steps to delete a TTG+PDG Profile.

1. In the **TTG+PDG Profile**, locate the TTG+PDG Profile that you want to delete.
2. Under the **actions** column, click the icon  that is in the same row as the TTG+PDG Profile name.

A confirmation message appears.

3. Click **Yes**.

The page refreshes, and the TTG+PDG Profile that you deleted disappears from the view list.

You have completed deleting a TTG+PDG profile.

## PMIPv6 Profiles

A PMIPv6 forwarding profile defines the policy for handling the mobility management of a mobile node using the proxy mobile IPv6 protocol.

### Configuring the Global LMA and MAG Options

Follow these steps to configure the global LMA and MAG.

1. Go to **Configuration** > **Services & Profiles**.
2. On the side menu, click **Forwarding** > **PMIPv6**.

The **PMIPv6 Service Profile** page appears.

In the **Global LMA & MAG Options** section, configure the following sections:

3. In the **LMA Failover Options** section, configure the following:
  - **LMA keep-alive interval:** Set the number of seconds at which the mobile node will send an alive notification message to the LMA (local mobility anchor). The default is 30 seconds.
  - **LMA keep-alive retries:** Set the maximum number of attempts that the LMA will send an echo-request message to the mobile node when the mobile node is not replying. When the maximum number of retries has been reached, the LMA will declare the mobile node as unreachable. The default is five retries.
4. In the **MAG Options** section, configure the following:
  - **Binding Refresh Time:** Set the number of seconds at which the binding entries in the controller will be refreshed. The default is 300 seconds.
5. Click **Apply**.

You have completed configuring the global LMA and MAG options for the PMIPv6 service profile.

### Creating a PMIPv6 Profile

A PMIPv6 forwarding profile defines the policy for handling the mobility management of a mobile node using the proxy mobile IPv6 protocol.

Follow these steps to create a PMIPv6 profile.

1. Go to **Configuration** > **Services & Profiles**.
2. On the side menu, click **Forwarding** > **PMIPv6**.

The **PMIPv6 Service Profile** page appears.

3. On the **PMIPv6 Service Profile** page, click **Create New**.

The **Create PMIPv6 Profile** form appears.

4. In **Name**, type a name for the profile that you are creating.
5. In **Description**, type a short description.
6. In **Primary LMA IP**, type the IP address of the primary local mobility anchor.
7. In **Secondary LMA IP**, type the IP address of the secondary local mobility anchor.
8. In **MN-ID Options**, specify the identifier to use for the mobile node by selecting one of the following options:

- **NAI from Authentication:** Select this option to use the Network Address Identifier (NAI) obtained during the authentication process.
- **MAC48@APN:** Select this option to use the 48-bit Media Access Control (MAC) identifier.

9. Click **Create New**.

You have completed creating a PMIPv6 service profile.

### Viewing PMIPv6 Profiles

Follow these steps to view the PMIPv6 profiles that have been created on the controller.

1. Go to **Configuration > Services & Profiles**.
2. On the side menu, click **Forwarding > PMIPv6**.

The **PMIPv6 Service Profile** page appears.


The PMIPv6 profiles that have been created appear below the **Global LMA & MAG Options** section.

### Deleting PMIPv6 Profiles

Follow these steps to delete a PMIPv6 profile.

1. Go to **Configuration > Services & Profiles**.
2. On the side menu, click **Forwarding > PMIPv6**.

The **PMIPv6** page appears.

3. Locate the profile that you want to delete.
4. Under the **Actions** column, click the icon  that is in the same row as the mixed mode profile name.

A confirmation message appears.

5. Click **Yes**.

The page refreshes, and the profile that you deleted disappears from the list.

You have completed deleting a PMIPv6 profile.

### Mixed Mode Profiles

A mixed mode forwarding profile defines the policy and configuration for mixed core network tunnels. This section covers:

#### Adding Mixed Mode Profile

A mixed mode forwarding profile defines the policy and configuration for mixed core network tunnels.

Follow these steps to add a mixed mode profile.

1. In **Mixed Mode Profiles**, click **Create New**.

The **Create New Mixed Mode Profiles** form appears.

2. In **Name**, type a name for the mixed mode profile that you are adding.
3. In **Description**, type a brief description of the profile created.



This is an optional field.

4. In **Forwarding Policy Per Realm**, specify the forwarding policy for each realm in the table. Configure the following:
  - **APN**
  - **APN Type**
  - **Route Type**
  - **Profile Name**
5. In **Default APN Settings**, configure the following:
  - **No Matching Realm Found**
  - **No Realm Specified**
6. In **Default APN Per Realm**, configure the following:
  - **Realm**
  - **Default APN**
7. Click **Create New**.

You have completed adding a mixed mode profile.

**Create New Mixed Mode Forwarding Profile**

Name:

Description:

Forwarding Policy per Realm

This table defines the forwarding policy for each APN.

<input type="checkbox"/>	APN	APN Type	Route Type
<input type="checkbox"/>			

Default APN Settings

Default APN when	Default APN
No Matching Realm Found	No data available
No Realm Specified	No data available

Default APN per Realm

The realm to default APN mapping defines the default APN for each of the realms specified in this table.

<input type="checkbox"/>	Realm	Default APN
<input type="checkbox"/>		

**Figure 95: Create a Mixed Mode Profile**

### Viewing Mixed Mode Profiles

Follow these steps to view a list of mixed mode profiles that have been configured.

1. Go to **Configuration > Services & Profiles**.
2. On the sidebar, click **Forwarding > Mixed Mode**.

3. This section displays the mixed mode profiles that you can use.

If you have not created a server, refer to [Adding Mixed a Mode Profile](#).

### Mixed Mode


View existing mixed mode forwarding profiles, or create a new one. A mixed mode forwarding profile defines the gateway and tunnel settings of the mixed mode supported on the same WLAN.

Name	Description
------	-------------

Figure 96: List view of Mixed Mode Profiles

### Deleting Mixed Mode Profiles

Follow these steps to delete a mixed mode profile.

1. Go to **Configuration > Services & Profiles**.
2. On the sidebar, click **Forwarding > Mixed Mode**.
3. On the **Mixed Mode** page, locate the mixed mode profile that you want to delete.
4. Under the **Actions** column, click the icon  that is in the same row as the mixed mode profile name.

A confirmation message appears.

5. Click **Yes**.

The page refreshes, and the mixed mode profile that you deleted disappears from the list.

You have completed deleting a mixed mode profile.

# Configuring the System Settings

# 7

In this chapter:

- [Overview of the System Settings](#)
- [Configuring General System Settings](#)
- [Configuring Cluster Planes](#)
- [Configuring Network Management](#)
- [Configuring Hosted AAA Services](#)

In this chapter:

## Overview of the System Settings

System settings refer to general controller settings, network management settings, and plane settings.

## Configuring General System Settings

To configure the general settings, go to the **Configuration** > **System** page, and then click **General System Settings** on the sidebar. Configuration tasks under general settings include:

### Setting the System Time

The controller uses an external network time protocol (NTP) server to synchronize the times across cluster nodes and managed access points.

Follow these steps to set the system time.

1. Go to **Configuration** > **System**.
2. Under **General System Settings**, click **System Time**.
3. In NTP Server, type the server address that you want to use. The default NTP server address is `pool.ntp.org`.
4. In **System Time Zone**, select the time zone that you want the controller to use. The default time zone is (GMT +0:00) UTC.
5. Click **Apply**.

## System Time

Set the NTP server that the system will use to synchronize time across cluster nodes and managed APs.

System Time:	2015-10-15 09:43:00 IST
System UTC Time:	2015-10-15 04:13:00 UTC
NTP Server:	* <input type="text" value="pool.ntp.org"/>
System Time Zone:	* <input type="text" value="(GMT+5:30) IST"/>

Figure 97: System time settings

### How APs Synchronize Time with the Controller

When an AP joins the controller, it automatically synchronizes its time with the controller system time. After that, the AP automatically synchronizes its time with the controller every day.

### Configuring the Syslog Server Settings

The controller maintains an internal log file of current events and this file has a fixed capacity. At a certain point, the controller will start deleting the oldest entries in log file to make room for newer entries.

If you want to keep a permanent record of all events that the controller generated, you can configure the controller to send the log contents to a syslog server on the network.

Follow these steps to configure the syslog server settings.

1. Go to **Configuration > System**.
2. Under **General System Settings**, click **Syslog Server**.

The **Syslog Server Settings** page appears.

3. Select the **Enable logging to remote syslog server** check box.
4. In **Primary Syslog Server Address**, type the IP address of the primary syslog server on the network. In **Port**, type the syslog port number on the primary server. In **Protocol**, select the UDP or TCP protocol as appropriate.

To verify that the controller can reach the syslog server that you want to use, click the **Ping Syslog Server** button that is in the same row as the primary syslog server address. If the syslog server is reachable, a flashing green circle and the message `Success` appear after the **Ping Syslog Server** button.

5. If another syslog server exists on the network and you want to use it as backup in case the primary systog server is unavailable, type its IP address in **Secondary Syslog Server Address**. In **Port**, type the syslog port number on the secondary server. In **Protocol**, select the UDP or TCP protocol as appropriate.

To verify that the controller can reach the syslog server that you want to use, click the **Ping Syslog Server** button that is in the same row as the primary syslog server address. If the syslog server is reachable, a flashing green circle and the message `Success` appear after the **Ping Syslog Server** button.

6. In **Event Filter**, select one of the following options to specify which events will be sent to the syslog server:
  - **All events**: Click this option to send all controller events to the syslog server.
  - **All events except client associate/disassociate events**: Click this option to send all controller events (except client association and disassociation events) to the syslog server.
  - **All events above a severity**: Click this option to send all controller events that are above the event severity that you specify in **Event Filter Severity**.
    - **Event Filter Severity**: (This option only appears when **All events above a severity** is selected.) Select the lowest severity level for which events will be sent to the syslog server. For example, if you select **Major**, all events that are major and higher (including critical) will be sent to the syslog server. For the order of event severity that the controller follows, see [Event Severity Levels](#).
7. In **Facility**, select the facility level that will be used by the syslog message. Options include **Local0 (default)**, **Local1**, **Local2**, **Local3**, **Local4**, **Local5**, **Local6**, and **Local7**.
8. In **Priority**, accept or change the default severity to priority mapping.  
See [Default Event Severity to Syslog Priority Mapping](#).
9. Click **Apply**.

## Syslog Server

Configure the remote syslog server to which event logs will be sent. You can also configure the types of events to send, syslog facility, and event

Enable logging to remote syslog server

Primary Syslog Server Address: \*  Port: \* 514 Protocol: \* UDP

Secondary Syslog Server Address:  Port: 514 Protocol: \* UDP

Facility for Application Logs: \* Local0

Facility for Administrator Activity Logs: \* Local0

Facility for Event: \* Local0

Event Filter: \*  All events  
 All events except client association/disassociation events  
 All events above a severity

Priority:

Event Severity	=>	Syslog Priority
Critical	=>	Error <input type="button" value="v"/>
Major	=>	Error <input type="button" value="v"/>
Minor	=>	Warning <input type="button" value="v"/>
Warning	=>	Warning <input type="button" value="v"/>
Informational	=>	Info <input type="button" value="v"/>
Debug	=>	Debug <input type="button" value="v"/>

Figure 98: Syslog server settings

### Event Severity Levels

The severity level of an event is displayed and used by administrators and registered by monitoring tools to indicate how severe or important an event is.

Table 6 describes the event severity levels (1 to 6, with 1 being the most severe) that the controller follows.

Table 11: Event severity levels in the controller

Level	Message	Description
1	Critical	A critical condition that must resolved immediately
2	Major	An error condition that must be resolved
3	Minor	An error condition that must be checked to determine if it needs to be resolved
4	Warning	Warning message, not an error, but indication that an error will occur if action is not taken
5	Informational	Normal operational messages - may be harvested for reporting, measuring throughput, etc. - no action required.

Level	Message	Description
6	Debug	Info useful to developers for debugging the application, not useful during operations.

### Default Event Severity to Syslog Priority Mapping

Table 7 lists the default event severity to syslog priority mapping in the controller.

**Table 12: Event severity to syslog priority mapping**

Event Severity	Syslog Priority
Critical	Error
Major	Error
Minor	Warning
Warning	Warning
Informational	Info
Debug	Debug

## Configuring the Northbound Portal Interface

Follow these steps to configure the northbound portal interface.

1. Go to the **Northbound Portal Interface** section.
2. In **Password**, type the password for the northbound portal interface.
3. Click **Apply**.

**NOTE:** If the NAT IP address is configured on the controller, the external subscriber portal (SP) can only communicate with the control interface and not the management interface.

### Northbound Portal Interface

Set the northbound portal interface password. 3rd party applications use the northbound portal interface to authenticate users and to retrieve user information.

Password: \*

**Figure 99: The Northbound Portal Interface section**

## Configuring the SMTP Server Settings

If you want to receive copies of the reports that the controller generates, configure the SMTP server settings and the email address to which the controller will send the reports.

Follow these steps to configure the SMTP server settings.

1. Go to the **SMTP Server Settings** section.
2. Select the **Enable SMTP Server** check box.
3. In **Logon Name**, type the logon or user name provided by your ISP or mail administrator.  

This might be just the part of your email address before the @ symbol, or it might be your complete email address. If you are using a free email service (such as Hotmail™ or Gmail™), you typically have to type your complete email address.
4. In **Password**, type the password that is associated with the user name above.
5. In **SMTP Server Host**, type the full name of the server provided by your ISP or mail administrator.  

Typically, the SMTP server name is in the format `smtp.company.com`.
6. In **SMTP Server Port**, type the SMTP port number provided by your ISP or mail administrator.  

Often, the SMTP port number is 25 or 587. The default SMTP port value is 25.
7. In **Mail From**, type the email address from which the controller will send email notifications.
8. In **Mail To**, type the email address to which the controller will send alarm messages. You can send alarm messages to a single email address.
9. If your mail server uses encryption, select the encryption method in **Encryption Options**.  

Options include TLS and STARTTLS. Check with your ISP or mail administrator for the correct encryption settings that you need to set.
10. Click **Apply**.

**SMTP Server**

Configure the SMTP server settings. The system uses these SMTP server settings to send email notifications.

Enable SMTP Server

Logon Name:

Password:

SMTP Server Host: \*

SMTP Server Port: \*

Mail From: \*

Mail To: \*

Encryption Options:  TLS

Figure 100: The SMTP Server Settings section

## Configuring the FTP Server Settings

Follow these steps to configure the FTP server settings for uploading raw report data (in CSV format).

1. Go to the **FTP Settings for Uploading Statistics** section.



2. Select the **Enable uploading statistics data to FTP server** check box.
3. In **Statistics Data Interval**, select the time interval at which the controller uploads a copy of raw statistical data to the FTP server. Options include:
  - **Hourly**: If you select this option, the controller will upload data to the FTP server every 20th minute of the hour (for example, 00:20, 01:20, 02:20 and so on).
  - **Daily**: If you select this option, the controller will upload data to the FTP server at 12:35AM every day.
4. In **FTP Server**, select the FTP server to which you want to upload the statistics data. The FTP server options that appear here are those that you created in [Configuring FTP Services](#) on page 165.
5. To verify that the FTP server settings and logon information are correct, click **Test**.  
If the server and logon settings are correct, the following message appears: `Test completed successfully.`
6. Click **Apply**.

**NOTE:** For detailed information on the statistics files that are exported to the FTP server and their content, see [Statistics Files the Controller Exports to an FTP Server](#) on page 405.

### FTP Server for Uploading Statistical Data

The screenshot shows a configuration panel titled "FTP Server for Uploading Statistical Data". At the top, there is a checked checkbox labeled "Enable uploading statistical data to the FTP server". Below this, there are two dropdown menus: "Statistics Data Interval" with "Daily" selected, and "FTP Server:" with "Select an FTP server" selected. To the right of the "FTP Server:" dropdown is a "Test" button. At the bottom of the panel are three buttons: "Refresh", "Apply", and "Cancel".

Figure 101: FTP server settings

## Setting Critical AP Auto Tagging Rules

A critical AP is an AP that exceeds the daily traffic threshold (sum of uplink and downlink) data bytes configured on the controller web interface.

Follow these steps to tag critical APs automatically.

1. Go to the **Critical AP Rules** section.
2. Select the **Enable Auto Tagging Critical APs** check box.
3. Under **Auto Tagging Rules**, select **Daily Traffic Bytes Exceeds Threshold**.
4. Under **Rule Threshold**, specify the threshold:
5. In the first box, type a value that you want to set as the traffic threshold.  
This value will be applied in conjunction with the data unit that you will select in the second box.
6. In the second box, select the data unit for the threshold – **M** for megabytes or **G** for gigabytes.

7. Click **Apply**.

APs that exceed the daily traffic threshold that you specified will appear highlighted on the **AP List** page and the **Access Point details** page. Additionally, the controller will send an SNMP trap to notify that an AP has been disconnected.

### Critical AP Rules

Configure the rules for tagging critical APs automatically. Critical APs are those that exceed the data traffic threshold that you define on this page. You can view a list of critical APs on the **Monitor > Access Points** page.

Enable Auto Tagging Critical APs

Auto Tagging Rules	Rule Threshold
Daily Data Traffic Bytes Exceeds Threshold ▼	<input type="text"/> GB ▼

Figure 102: Critical AP tagging rules

## Configuring Q-in-Q Ether Type

Follow these steps to configure the Q in Q Ether type.

1. Go to **Configuration > System**.
2. On the sidebar, click **Q-in-Q Ether Type**.

The **Q-in-Q Ether Type** page appears.

3. From the drop-down list, select the **Q-in-Q Ether Type** format.

Alternatively, you can type in a value if it cannot be found on the list. The value should be 4 Hex digits with optional prefix 0x/0X.

4. Click **Apply** to save the changes.

You have completed configuring the Q-in-Q Ether Type.

### Q-in-Q Ether Type

Select the Q-in-Q ether type format. This format is used by Q-in-Q 3rd party AP zones.

Q-in-Q Ether Type:  Please type a value if it cannot be found in the list. The value should be four (4) HEX digits with optional prefix 0x/0X.

Figure 103: Configuring the Q-in-Q Ether Type

## Managing the Global User Agent Black List

Follow these steps to configure the global user agent black list.

1. Go to **Configuration > System**.
2. On the sidebar, click **Manage Global User Agent Black List** to view the page.
3. Click **Add New** to enter the **name**, **user agent pattern**, and **error**.
4. Click **Save**.

You have completed adding an agent to the black list.

## Manage User Agent Blacklist

View list of user agents (specified in WISPr clients header requests) which will be blocked when UE is unauthenticated.

<input type="checkbox"/>	Name ▲	User Agent Pattern	Error	Error Mes...	Action
<input type="checkbox"/>	DivX Player	.*DivX Player.*	503	Un-authori...	
<input type="checkbox"/>	Google Update	.*Google Update.*	503	Un-authori...	
<input type="checkbox"/>	Microsoft BITS	.*Microsoft BITS.*	503	Un-authori...	
<input type="checkbox"/>	MSDW	.*MSDW.*	503	Un-authori...	
<input type="checkbox"/>	Skype WISPr	.*[sS]kype.*	503	Un-authori...	
<input type="checkbox"/>	StubInstaller	.*StubInstaller.*	503	Un-authori...	
<input type="checkbox"/>	Symantec LiveUpdate	.*Symantec LiveUpdate.*	503	Un-authori...	
<input type="checkbox"/>	Syncer	.*Syncer.*	503	Un-authori...	
<input type="checkbox"/>	TrendMicro client	.*TMUFE.*	503	Un-authori...	
<input type="checkbox"/>	VCSoapClient	.*VCSoapClient.*	503	Un-authori...	
<input type="checkbox"/>	Windows Live Essentials	.*[Ww]indows [Ll]ive [Ee]ssentials.*	503	Un-authori...	

Figure 104: Global user agent black list

## Configuring SCI Settings

SmartCell Insight uses data from the controller to analyse performance and generate reports about the WiFi network. Configuring the SCI settings in the controller enables data transfer from the controller to the SCI server using the MQTT protocol.

Follow these steps to configure the SCI server settings.

**1. Go Configuration > System > SCI Setting.**

The **SCI Setting** page is displayed.

**2. Select the Enable SCI Server check-box to configure the SCI server settings.**

**3. In SCI System ID, enter the ID of the SCI system you plan to access.**

**4. In SCI Server Host, type the IP address to the SCI host server.**

**5. In SCI Server Port, type the port number over which the SCI server and controller can communicate and transfer data.**

**6. Click Apply.**

You have completed configuring the SCI server settings for the controller.

### SCI Setting

Enable SCI Server

SCI System ID:

SCI Server Host: \*

SCI Server Port: \*

Figure 105: The SCI Setting section

## Enabling and Configuring Node Affinity

Node affinity enables administrators to manually configure the controller nodes to which APs will connect.

To do this, set the order of preferred nodes on the node affinity page. Node affinity is implemented at the AP zone level, which means that all APs that belong to a zone will have the same node affinity settings.

If you want APs that belong to the same zone to connect to the same node whenever possible, you can configure set the preferred node for a particular zone.

**NOTE:** Enabling node affinity automatically disables cluster redundancy.

Follow these steps to enable and configure node affinity.

1. Go to **Configuration > System**.
2. Under **General System Settings**, click **Node Affinity**.
3. Select the **Enable Node Affinity** check box, and then click **Apply**.
4. Edit the default node affinity profile or create a new profile.

An affinity profile defines the order of the nodes to which APs that belong to the same zone will connect.

- a) To edit the default profile, click the profile name that appears under the **Node Affinity Profile** section.

The **Edit Node Affinity Profile** form appears and displays all nodes that belong to the cluster.

- b) Click the green up and down buttons under the **Action** column to set the order of node priority.

Make sure that the preferred node is at the top of the list.

- c) To create a new, click **Create New**.

- d) In the **Create Node Affinity Profile** form, type a name and description.

- e) Click the green up and down buttons under the **Action** column to set the order of node priority.

Make sure that the preferred node is at the top of the list.

- f) Click **OK** when done.

5. In the **Node Affinity Setting** section, set the number of times an AP will attempt to connect to the preferred node.

The default value is 3 and the accepted range is 1 to 10. If the AP is unable to connect to the preferred node, it will attempt to connect to the node that is next in the order of node priority.

6. In the **Zone Assignment** section, set the node affinity profile that you want each zone to use. Do the following:

- a) Select the check box for the zone

- b) Click **Assign Profile**.
- c) In **Node Affinity Profile**, select the profile that you want to assign to the node.
- d) Click **Apply**.

Repeat this procedure for each zone.

- 7. Click **Apply** at the bottom of the page to save your changes.

### Node Affinity

Enable Node Affinity  
Cluster redundancy will not work if node affinity is enabled.

**Node Affinity Profile**

Refresh Create New

<input type="checkbox"/>	Name	Description	Node Order
<input type="checkbox"/>	preferrin...	Generated by system.	SCG-3-2-LEAD

Node Affinity Settings

# of Node Retry for Preferred Node (1 ~ 10):

**Zone Assignment**

Assign Profile Search terms:   Include all terms  Include any of these terms

<input type="checkbox"/>	Zone Name	Node Affinity Profile
<input type="checkbox"/>	Zone1	

Show 20 << | 1 | >> 1 total records

Figure 106: Use the Node Affinity page to set the preferred node of each zone

## Managing the Certificate Store

The certificate store is the central storage for all the security certificates that the controller uses for its web interface, AP portal, and hotspots.

By default, a Ruckus Wireless-signed SSL certificate (or security certificate) exists in the controller. However, because this default certificate is signed by Ruckus Wireless and is not recognized by most web browsers, a security warning appears whenever you connect to the web interface or users connect to the AP portal or a hotspot. To prevent these security warnings from appearing, you can import an SSL certificate that is issued by a recognized certificate authority.

This section describes the steps you need to perform to import and apply an SSL certificate to the web interface, AP portal, or hotspots. Topics include:

**NOTE:** The certificate that you will use for Hotspot 2.0 OSEN must be issued by a certificate authority (CA) authorized by the Wi-Fi Alliance (WFA). Otherwise, it will not appear on the list of certificates that you can use for Hotspot 2.0 OSEN.

If you are implementing Hotspot 2.0 on the network and you want to support anonymous authentication using OSU Server-Only Authenticated L2 Encryption Network (OSEN), you will need to import a trust root certificate, server or intermediate certificate and private key.

## Generating a Certificate Signing Request

The certificate store is the central storage for all the security certificates that the controller uses for its web interface, AP portal, and hotspots.

This section describes how to generate a certificate signing request (which you need to obtain a signed certificate) and how to import a signed certificate into the controller.

**NOTE:** If you already have an SSL certificate that you want to import into the controller, go to [Importing an SSL Certificate](#).

If you do not have an SSL certificate, you will need to create a certificate signing request (CSR) file and send it to an SSL certificate provider to purchase an SSL certificate. The controller web interface provides a form that you can use to create the CSR file. Follow these steps to generate a certificate request.

1. Go to **Configuration > System**.

2. On the sidebar, click **Certificate Store**.

The **Certificate Store** page appears.

3. In the **Certificate Signing Request (CSR)** section, click **Generate**.

The **Generate New Certificate Signing Request (CSR)** form appears.

4. In **Name**, type a name for this CSR.

5. In **Description**, type a description for this CSR.

6. In the **Certificates Signing Request (CSR)** section, fill out the following boxes:

a) **Common Name:** Type the fully qualified domain name of your Web server. This must be an exact match (for example, `www.ruckuswireless.com`).

b) **Email:** Type your email address (for example, `joe@ruckuswireless.com`).

c) **Organization:** Type the complete legal name of your organization (for example, `Ruckus Wireless, Inc.`).

Do not abbreviate your organization name.

d) **Organization Unit:** Type the name of the division, department, or section in your organization that manages network security (for example, `Network Management`).

e) **Locality/City:** Type the city where your organization is legally located (for example, `Sunnyvale`).

f) **State/Province:** Type the state or province where your organization is legally located (for example, `California`).

Do not abbreviate the state or province name.

g) **Country:** Select the country where your organization is location from the drop-down list.

7. Click **OK**.

The controller generates the certificate request. When the certificate request file is ready, your web browser automatically downloads it.

8. Go to the default download folder of your Web browser and locate the certificate request file. The file name is `myreq.zip`.
9. Use a text editor (for example, Notepad) to open the certificate request file.
10. Go to the website of your preferred SSL certificate provider, and then follow the instructions for purchasing an SSL certificate.
11. When you are prompted for the certificate signing request, copy and paste the entire content of `myreq.csr`, and then complete the purchase.

After the SSL certificate provider approves your CSR, you will receive the signed certificate via email. The following is an example of a signed certificate that you will receive from your SSL certificate provider:

```
-----BEGIN CERTIFICATE-----  
[Redacted Certificate Content]  
-----END CERTIFICATE-----
```

12. Copy the content of the signed certificate, and then paste it into a text file.
13. Save the file.

You may now import the signed certificate into the controller. Refer to [Importing an SSL Certificate](#) for more information.

**Generate new Certificates Signing Request (CSR)**

Name: \*

Description:

Certificates Signing Request (CSR)

Common Name: [?] \*

Email: [?] \*

Organization: [?] \*

Organization Unit: [?]

Locality/City: [?] \*

State/Province: [?] \*

Country: \* United States ▼

OK Cancel

**Figure 107: Generating a certificate signing request**

### Importing an SSL Certificate

If you have an SSL certificate issued by an SSL certificate provider, you can import it into the controller and use it for HTTPS communication.

To complete this procedure, you will need the following items:

- The signed server certificate
- The intermediate CA certificate (at least one)
- The private key file

**NOTE:** The file size of each signed certificate and intermediate certificate must not exceed 8192 bytes. If a certificate exceeds 8192 bytes, you will be unable to import it into the controller.

1. Copy the signed certificate file, intermediate CA certificate file, and private key file to a location (either on the local drive or a network share) that you can access from the controller web interface.
2. Go to **Configuration > System**.
3. On the sidebar, click **Certificate Store**.  
The **Certificate Store** page appears.
4. In the **Installed Certificates** section, click **Import**.  
The **Import New Certificate** form appears.
5. Import the server certificate by completing the following steps:
  - a) In **Server Certificate**, click **Browse**.  
The **Open** dialog box appears.
  - a) Locate and select the certificate file, and then click **Open**.
6. Import the intermediate CA certificate by completing the following steps:
  - a) In **Intermediate CA certificate**, click **Browse**.  
The Open dialog box appears.
  - b) Locate and select the intermediate CA certificate file, and then click **Open**.
7. If you need to upload additional intermediate CA certificates to establish a chain of trust to the signed certificate, repeat the above step.
8. **NOTE:** If you are using this SSL certificate for a Hotspot 2.0 configuration, you must also import a root CA certificate. See the *Hotspot 2.0 Portal Integration Reference Guide* for this release.

When you finish uploading all the required intermediate certificates, import the private key file either by uploading file itself or selecting the CSR you generated earlier.

- a) To upload the private key file, click **Upload**, then click **Browse**, then locate and select the private key file, and then click **Open**.
  - b) To select the CSR, click **Using CSR**, then select the CSR that you generated earlier.
9. In **Key Phrase**, enter the passphrase that has been assigned to private key file.
  10. Click **OK**.

The page refreshes and the certificate you imported appears in the **Installed Certificate** section.

You have completed importing a signed SSL certificate to the controller.



Import new Certificate

Name: \*

Description:

Server Certificate

Server Certificate: \*

Intermediate CA certificate:    [?]

Root CA certificate: [?]

Private Key: \*  Upload

Using CSR

Key Passphrase:

OK Cancel

Figure 108: The Import New Certificate form

### Assigning Certificates to Services

Follow these steps to specify the certificate that each secure service will use.

1. Go to **Configuration > System**.
2. On the sidebar, click **Certificate Store**.

The **Certificate Store** page appears.

3. In the **Service Certificates** section, select the certificate that you want to use for each service.
4. Click **Apply**.

You have completed assigning certificates to services.

## Certificate Store

This page displays all the certificates being managed by the controller.

### Installed Certificates

Refresh Import New Delete Selected Search terms:  x  Include all terms  Include any of these terms

Name ▲	Description
Default Certificate	

Show 20 << | 1 | >>

### Service Certificates

Service	Certificate
Management Web:	Default Certificate ▼
AP Portal:	No data available ▼
Hotspot (WISPr):	Default Certificate ▼
Communicator:	Default Certificate ▼

View Public Key

Refresh Apply Cancel

### Certificates Signing Request (CSR)

Refresh Generate Delete Selected Search terms:  x  Include all terms  Include any of these terms

Name ▲	Description
--------	-------------

Show 20 << | 1 | >>

Figure 109: The Service Certificates section

## Configuring Advanced Gateway Options

As part of the TTG enhancements in this release, a number of features (collectively known as advanced gateway options) are now configurable from the web interface – these features no longer depend on flat file changes.

Follow these steps to configure advanced gateway options.

1. Go to the **Configuration > General System Settings > Gateway Advanced Options** page.
2. Configure the following options:
  - **Allow Session on Accounting Fail:** This setting allows the controller TTG to terminate calls if accounting response fails. The default setting is **No**.
  - **GTP Network Service Access Point Identifier [NSAPI]:** This setting is used to select NSAPI for GTP message. The default setting is **1**.
  - **Include IMEI IE in GTP Messages:** This setting is used to enable or disable IMEI IE in GTP messages. The default setting is **No**.

NOTE: In IMEI IE, the controller will send the MAC address of the UE appended with FFFE.

- **Include SCG-RAI in GTPV2:** This setting will only be used when the S5/S8 interface is used for GTPv2.

- **Include SCG-SAI in GTPV2:** This setting will only be used when the S5/S8 interface is used for GTPv2
- **Include ECGI in GTPV2:** This setting will only be used when the S5/S8 interface is used for GTPv2:
- **Include TAI in GTPV2:** This setting will only be used when the S5/S8 interface is used for GTPv2.

NOTE: The default GTPv2 interface for the controller is S2a.

3. Click **Apply**.

Gateway Advanced Options

Allow Session on Accounting Fail:	* Yes ▼
GTP Network Service Access Point Identifier [NSAPI]:	* 1
Include IMEI IE in GTP Messages:	* No ▼
Include SCG-RAI in GTPV2 Messages:	* No ▼
Include SCG-SAI in GTPV2 Messages:	* No ▼
Include ECGI in GTPV2 Messages:	* Yes ▼
Include TAI in GTPV2 Messages:	* Yes ▼

Refresh Apply Cancel

Figure 110: Configure the gateway advanced options as needed

## Configuring Cluster Planes

To view the cluster planes that exist in the cluster, go to **Configuration > System > Cluster Planes**.

The **Cluster Planes** page appears and displays a summary of the data planes and control planes that belong to the cluster.

This section covers:

Cluster Planes

System IP Mode

The system is capable of operating in either 'IPv4-only' or 'dual-stack (IPv4 plus IPv6)' mode. Please select your mode and verify appropriate network connectivity.

IP Support Version:  IPv4 only  IPv4 and IPv6

Refresh Apply Cancel

Refresh Rebalance APs

Control Planes

View existing control planes in the cluster. To view details about a control plane or to update its configuration, click the control plane name.

Name	Managem...	Cluster IP	Control IP	Model	Serial Number	# of APs	Description
SCG-3-2-LEAD-C	172.19.13.56	10.138.71.56	10.138.70.56	SCG200	207000029	1	SCG-3-2-LEAD

Data Planes

View existing data planes and basic information about them. To view detailed information about a specific data plane, click the data plane name.

Name	DP MAC Ad...	IP Address	Managed By	Model	Serial Number	# of Ruckus ...	Firmware
SCG-3-2-LEAD-D1	50:A7:33:25...	150.138.90.34	SCG-3-2-LEAD	CN5750p...	2.0G1145-FP700011	1	3.2.0.0.792
SCG-3-2-LEAD-D0	50:A7:33:25...	150.138.90.33	SCG-3-2-LEAD	CN5750p...	2.0G1145-FP700004	0	3.2.0.0.792

Figure 111: Cluster Plane view

## Setting the System IP Mode

The controller supports IPv4 only and IPv4 and IPv6 addressing modes. The system IP mode controls the format of the IP address that you need to enter in a number of IP address-related settings (for example, cluster plane addresses, static routes, management ACLs, etc.).

Follow these steps to change the controller's system IP mode.

1. Go to **Configuration > System**.
2. On the sidebar, click **Cluster Planes**.
3. In the **System IP Mode** section, select the system IP mode that you want to controller to use. Options include:
  - **IPv4 Only**
  - **IPv4 and IPv6**
4. Click **Apply**.

You have completed setting the system IP mode.

Cluster Planes

System IP Mode

The system is capable of operating in either 'IPv4-only' or 'dual-stack (IPv4 plus IPv6)' mode. Please select your mode and verify appropriate network connectivity.

IP Support Version:  IPv4 only  IPv4 and IPv6

Refresh Apply Cancel

Figure 112: The System IP Mode section

## Rebalancing APs Across Nodes

When a multi-node cluster is upgraded, the node that reboots the last typically does not have any APs associated with it.

To ensure that the AP load is evenly distributed across the nodes in the cluster, rebalance APs across the nodes. For information on how the AP rebalancing process works, see [How AP Rebalancing Works](#) on page 221.

1. Go to **Configuration > System**.
2. On the sidebar, click **Cluster & Planes > Cluster Planes**.  
Information about the nodes that belong to the cluster, including the number of APs associated with each node, appears in the section.
3. Click **Rebalance APs**. A confirmation message appears.
4. Click **Yes**.

The controller rebalances AP connections across the nodes over the next 15 minutes.

**NOTE:** If you want to repeat this procedure, you must wait 30 minutes before the controller will allow you to rebalance APs again.

The screenshot shows the 'Cluster Planes' configuration page. At the top, there are navigation tabs: Dashboard, Monitor, Configuration, Report, Identity, Device, and Administration. The left sidebar contains various system settings categories, with 'Cluster & Planes' selected. The main content area is titled 'Cluster Planes' and includes a 'System IP Mode' section with radio buttons for 'IPv4 only' and 'IPv4 and IPv6'. Below this is a 'Rebalance APs' button. The 'Control Planes' section contains a table with columns: Name, Management IP, Cluster IP, Control IP, Model, Serial Number, # of APs, Description, Firmware, Cluster Role, Uptime, and Actions. The 'Data Planes' section contains a table with columns: Name, DP MAC Address, IP Address, Managed By, Model, Serial Number, # of Ruckus..., Firmware, Last Seen On, Status, Uptime, and Actions.

Name	Management IP	Cluster IP	Control IP	Model	Serial Number	# of APs	Description	Firmware	Cluster Role	Uptime	Actions
SCG-10-C	172.19.8.10	10.1.97.42	10.1.96.42 / ...	SCG200	3213270001...	0	SCG-41-test	3.2.1.0.71	Follower	11d 17m	
SCG-41-C	172.19.6.41	10.1.97.41	10.1.96.41 / ...	SCG200	9913070000...	1	SCG3.2.1 IPv6 Test	3.2.1.0.71	Leader	11d 10m	

Name	DP MAC Ad...	IP Address	Managed By	Model	Serial Number	# of Ruckus ...	Firmware	Last Seen On	Status	Uptime	Actions
SCG-41-D0	54-3D-37-35...	60.0.0.41 / ::	SCG-41	CN5750p...	2.0G1230-PP700310	0	3.2.1.0.48	2015/12/14 11:35:55	Managed	10d 23h 50m	
SCG-10-D1	24-C9-A1-3E...	50.0.0.30 / ::	SCG-10	CN5750p...	2.0G1304-PP700154	1	3.2.1.0.48	2015/12/14 11:38:01	Managed	10d 17h 58m	
SCG-41-D1	54-3D-37-35...	60.0.0.42 / ::	SCG-41	CN5750p...	2.0G1222-PP700040	0	3.2.1.0.48	2015/12/14 11:36:02	Eth down	0s	
SCG-10-D0	24-C9-A1-3E...	50.0.0.29 / ::	SCG-10	CN5750p...	2.0G1304-PP700017	0	3.2.1.0.48	2015/12/14 11:35:56	Managed	10d 17h 58m	

**Figure 113: Click Rebalance APs to evenly distribute the AP load across the nodes**

### How AP Rebalancing Works

AP rebalancing helps distribute the AP load across nodes that exist within a cluster.

When you click the **Rebalance APs** button, the following process is triggered:

1. The controller calculates the average AP count based on the number of available control planes and data planes.
2. The controller calculates how many APs and which specific APs must be moved to other nodes to distribute the AP load.
3. The controller regenerates the AP configuration settings based on the calculation result.
4. The web interface displays a message to inform the administrator that the controller has completed its calculations for rebalancing APs.

5. Each AP that needs to be moved to a different node retrieves the updated AP configuration from the controller, reads the control planes and data planes to which it must connect, and then connects to them..

When the AP rebalancing process is complete, which typically takes 15 minutes, one of the following events is generated:

- Event 770: Generate ApConfig for plane load rebalance succeeded.
- Event 771: Generate ApConfig for plane load rebalance failed.

### Important Notes About AP Rebalancing

If you are rebalancing the AP load across the nodes in a cluster, take note of the following caveats:

- APs may recreate the Ruckus-GRE tunnel to a different data plane.
- Devices associated with an AP that uses the Ruckus-GRE tunnel may temporarily lose network connection for a short period of time (typically, around five minutes) during the AP rebalancing process.
- When [node affinity](#) is enabled, AP rebalancing is disallowed on those nodes.
- When data plane grouping is enabled, AP rebalancing is disallowed on those data planes.
- AP rebalancing only supports APs running release 3.2 firmware. APs running on legacy firmware will not be rebalanced.

### Configuring Control Planes

Configuring control planes involves defining the physical interface, user defined interface, and static routes.

Three tabs exist in the **Control Planes** section:

Refer to the following sections on how to configure the settings on these three tabs.

- Physical Interface Tab
- User Defined Interface Tab
- Static Routes Tab

**NOTE:** If you disable the control plane interface, you will no longer be able to access the controller web interface to perform any management or administrative tasks.

#### Physical Interface Tab

Follow these steps to configure the physical interface settings of a control plane.

You must configure the control, cluster, and management interfaces to be on three different subnets. Failure to do so may result in loss of access to the web interface or failure of system functions and services.

1. Locate the interface settings that you want to update.

You can update any of the following interfaces:

- **Control** interface (IPv4 and IPv6)

- **IPv4 Cluster** interface
- **Management** interface (IPv4 and IPv6)

**NOTE:** Although it is possible to use DHCP to assign IP address settings to the management interface automatically, Ruckus Wireless strongly recommends assigning a static IP address to this interface.

2. Configure the following settings for the **IPv4-Control Interface** that you want to update.
  - a) **IP Mode:** Configure the IP address mode by clicking one of the following options:
    - **Static:** Click this if you want to assign an IP address to this interface manually.
    - **DHCP:** Click this if you want this interface to obtain an IP address automatically from a DHCP server on the network. After you click this option, most of the options below it will be grayed out.
  - b) **IP Address:** Enter the IP address that you want to the assign to this interface.
  - c) **Subnet Mask:** Enter the subnet mask for the IP address above.
  - d) **Gateway:** Enter the IP address of the gateway router.
  - e) **Control NAT IP:** Enter the NAT IP address.
3. Configure the following settings for the **IPv4-Management Interface** and the **IPv4-Cluster Interface** that you want to update.
  - a) **IP Mode:** Configure the IP address mode by clicking one of the following options:
    - **Static:** Click this if you want to assign an IP address to this interface manually.
    - **DHCP:** Click this if you want this interface to obtain an IP address automatically from a DHCP server on the network. After you click this option, most of the options below it will be grayed out.
  - b) **IP Address:** Enter the IP address that you want to the assign to this interface.
  - c) **Subnet Mask:** Enter the subnet mask for the IP address above.
  - d) **Gateway:** Enter the IP address of the gateway router.
4. Configure the following settings for the **IPv6-Control Interface** and the **IPv6-Management Interface** that you want to update.
  - a) **IP Mode:** Configure the IPv6 address mode by clicking one of the following options:
    - **Static:** Click this if you want to assign an IPv6 address to this interface manually, and then configure the following:

**IP Address:** Enter an IPv6 address (global only) with a prefix length (for example, 1234::5678:0:C12/123) is required. Link-local addresses are unsupported.

**Gateway:** Enter an IPv6 address (global or link-local) without a prefix length. For example, 1234::5678:0:C12 (global address without a prefix length) and fe80::5678:0:C12 (link-local address without a prefix length).
    - **Auto:** Click this if you want the interface to obtain its IP address from Router Advertisements (RAs) or from a DHCPv6 server on the network.

- In **Access & Core Separation**, select the **Enable** check box if you want the management interface (core side) to be the system default gateway.

The control interface (access side) will be used for access traffic only.

- In **Default Gateway**, select the gateway that you want use - CLuster, COntrOl and Management (IPv4 and IPv6).

The options that appear here are the gateways that you have defined for control, cluster, and management interfaces.

**NOTE:** When **Access & Core Separation** is enabled, the **Default Gateway** field is hidden.

- In **Primary DNS Server** and **Secondary DNS Server**, configure the DNS servers that you want the controller to use.

- Click **Apply**.

The controller restarts and applies the updated network interface settings. You have completed updating the physical interface settings.

**NOTE:** For information on how to configure the management IP address from the command line interface, refer to the corresponding *Command Line Interface Reference Guide* for your controller platform.

**Figure 114: The Physical Interface tab**

### User Defined Interface Tab

Use the **User Defined Interface** tab to configure the service settings (captive portal, subscriber portal, and Web proxy).

Note that you can only create one user defined interface, and it must be for a service and must use the control interface as its physical interface.

**NOTE:** The user defined interface (UDI) is unavailable in Virtual SmartZone (High-Scale and Essentials).

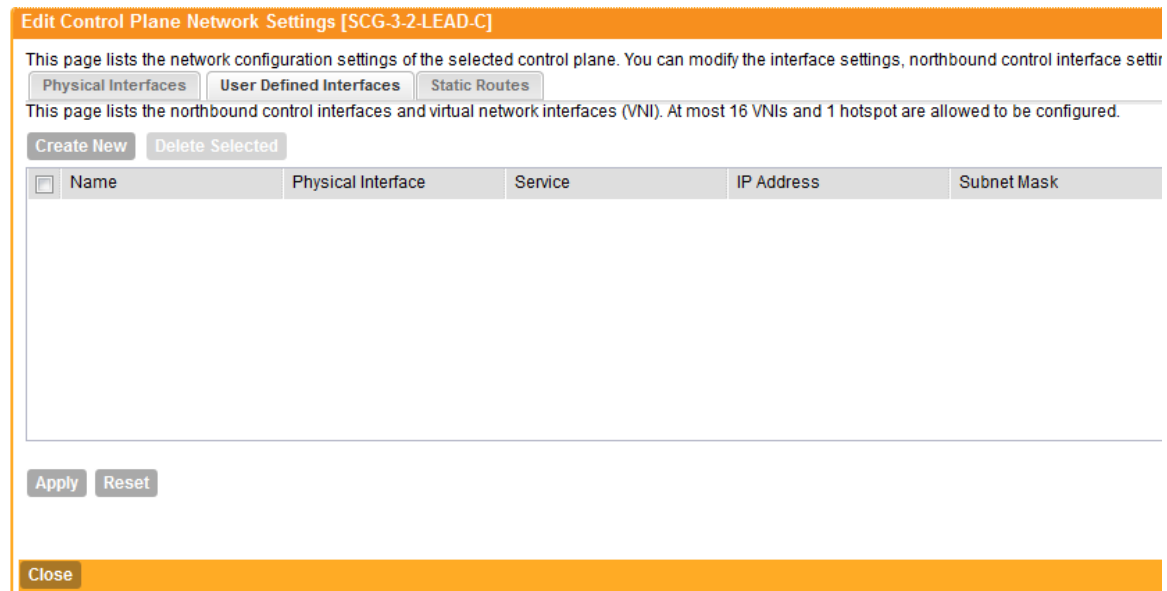


**NOTE:** The control plane and the UDI must be on different subnets. If the control plane and UDI are on the same subnet and assigned the same IP address, APs will be unable to communicate with the control plane. If the control plane and UDI are on the same subnet and assigned different IP addresses, hotspot clients will not be redirected to the logon URL for user authentication.

Follow these steps to configure the settings on the **User Defined Interface** tab.

1. Click the **User Defined Interfaces** tab.
2. Click the **Create New** button.
3. Configure the following interface settings:
  - a) **Name:** Enter a name for this interface.
  - b) **IP Address:** Enter an IP address to assign to this interface.
  - c) **Subnet Mask:** Enter a subnet mask for the IP address above.
  - d) **Gateway:** Enter the IP address of the gateway router.
  - e) **VLAN:** Enter the VLAN ID that you want to assign to this interface.
  - f) **Physical Interface:** Select either **Control Interface** or **Management Interface**.
  - g) **Service:** Select **Hotspot** or **Not Specified**.
4. Click **Save**.
5. Click **Apply**.

You have completed configuring the northbound portal interface settings.



**Figure 115: The User Defined Interface tab**

### Static Routes Tab

To configure a static route, enter the destination IP address and related information for the destination. You can also assign a metric (or priority) to help the controller determines the route to choose when there are multiple routes to the same destination.

Follow these steps to configure a static route.

1. Click the **Static Routes** tab.
2. Click the **Create New** button.
3. Configure the following interface settings:
  - a) **Network Address**: Enter the destination IP address of this route.
  - b) **Subnet Mask**: Enter a subnet mask for the IP address above.
  - c) **Gateway**: Enter the IP address of the gateway router.
  - d) **Interface**: Select the physical interface to use for this route.
  - e) **Metric**: This represents the number of routers between the network and the destination.
4. Click **Save**.
5. Click **Apply** to save your changes.

You have completed configuring a static route.

## Cluster Planes

System IP Mode

The system is capable of operating in either 'IPv4-only' or 'dual-stack (IPv4 plus IPv6)' mode. Please select your mode and verify appropriate network connect

IP Support Version:  IPv4 only  IPv4 and IPv6

Refresh Apply Cancel

Refresh Rebalance APs

Control Planes

View existing control planes in the cluster. To view details about a control plane or to update its configuration, click the control plane name.

Name	Management IP	Cluster IP	Control IP	Model	Serial Number	# of APs	Description	F
SCG-3-2-LEAD-C	172.19.13.56	10.138.71.56	10.138.70.56	SCG200	207000029	1	SCG-3-2-...	3.

Edit Control Plane Network Settings [SCG-3-2-LEAD-C]

This page lists the network configuration settings of the selected control plane. You can modify the interface settings, northbound control interface setting

Physical Interfaces User Defined Interfaces **Static Routes**

This table lists the static routes that have been configured.

Create New Delete Selected

<input type="checkbox"/>	Network Address	Subnet Mask	Gateway	Interface
--------------------------	-----------------	-------------	---------	-----------

Figure 116: The Static Route tab

## Configuring a Data Plane

By default, the controller sends traffic from its data plane from a single interface. If your organization's network requires separation of the access and core traffic, configure access and core separation on the controller.

Follow these steps to configure the interface settings of a data plane.

1. Go to **Configuration > System**.
2. On the side menu, click **Cluster Planes**.  
The **Cluster Planes** page appears.
3. Scroll down to the **Data Planes** section, and then click the name of the data plane that you want to configure.  
The **Edit Data Plane Network Settings [{node name}]** form appears.

4. In **Interface Mode**, select one of the following options:
- **Single Interface** (default): Select this option if you want the controller to send traffic from its data plane from a single interface.
  - **Access and Core Interfaces**: Select this option if you want the controller to send traffic to the access and core networks separately.

If you choose to separate the access and core networks, take note of the following:

- If the data plane is required to connect to IP addresses in the core network (for example, for DHCP relay or L2oGRE termination) and the destination IP addresses are not part of the core subnet, you must use static routes.
  - There are no predefined access and core interfaces on the SCG-200. You can use either ports on the rear panel of the controller to connect to the access network and core network.
5. In the **Primary (Access) Interface** section, configure the interface settings:
- a) **Interface Mode**: Select the **Single Interface** or **Access and Core Interface** mode.
  - b) **IP Mode**: Click one of the following options:
    - **Static**: Click this if you want to assign an IP address to this interface manually.
    - **DHCP**: Click this if you want this interface to obtain an IP address automatically from a DHCP server on the network. After you click this option, most of the options below it will be grayed out.
  - c) **IP Address**: Enter the IP address of the primary interface or, if you are selected **Access and Core Interfaces** in the previous step, the access network interface.
  - d) **Subnet Mask**: Enter the subnet mask for the IP address above.
  - e) **Gateway**: Enter the IP address of the gateway router.
  - f) **Primary DNS**: Enter the IP address of the primary DNS server.
  - g) **Secondary DNS**: Enter the IP address of the secondary DNS server.
  - h) **VLAN**: If you need to tag traffic with a VLAN ID, enter the VLAN ID number.
  - i) **NAT IP**: Enter the Network Address Translation IP address.
6. Configure the following IPv6 primary data plane interface settings:
- a) **IP Mode**: Click one of the following options:
    - **Static**: Click this if you want to assign an IP address to this interface manually.
    - **Auto**: Click this if you want this interface to obtain an IP address automatically from a DHCP server on the network. After you click this option, most of the options below it will be grayed out.
  - b) **IP Address**: Enter the IP address that you want to the assign to this interface.
  - c) **Gateway**: Enter the IP address of the gateway router.
  - d) **Primary DNS**: Enter the IP address of the primary DNS server.
  - e) **Secondary DNS**: Enter the IP address of the secondary DNS server.
7. In the **Secondary (Core) Interface** section, configure the interface settings:
- a) **IP Address**: Enter the IP address of the core network interface.

**NOTE:** The secondary/core interface IP address is must be configured manually; DHCP is unsupported.

- b) **Subnet Mask:** Enter the subnet mask for the IP address above.
- c) **VLAN:** If you need to tag traffic with a VLAN ID, enter the VLAN ID number.

**NOTE:** If VLANS are configured on both the access and core networks, the VLAN ID that you enter here must be different from the VLAN ID that you entered for the primary/access interface.

**NOTE:** You cannot configure the IP address and VLAN settings for a virtual Data Plane from the **Primary (Access)** and **Secondary (Core) Interface** sections.

Only vSZ-H supports virtual Data Plane.

**8.** Configure static route settings as follows:

- a) Click **Create New** to create a new static route.
- b) Enter the following information:
  - **Network Address:** Enter the network IP address.
  - **Subnet Mask:** Enter the subnet mask IP address.
  - **Gateway:** Enter the IP address of the gateway router.
- c) Click **OK**.  
The static route settings are configured and displayed.

You can delete a static route by selecting the check box and clicking the  icon.

**9.** Click **Apply**.

You have completed configuring the interface settings of a data plane.

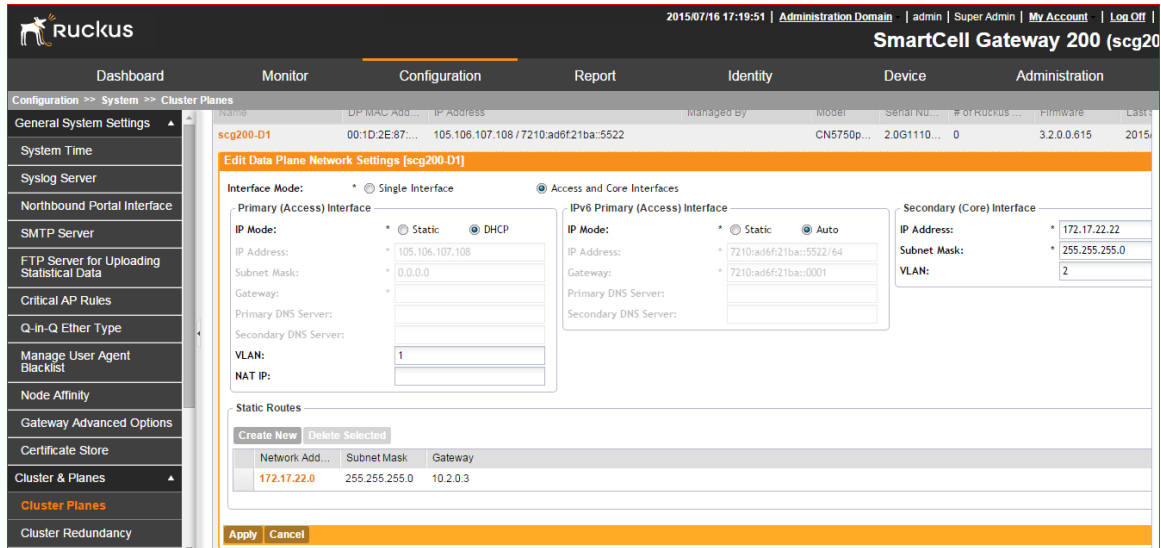


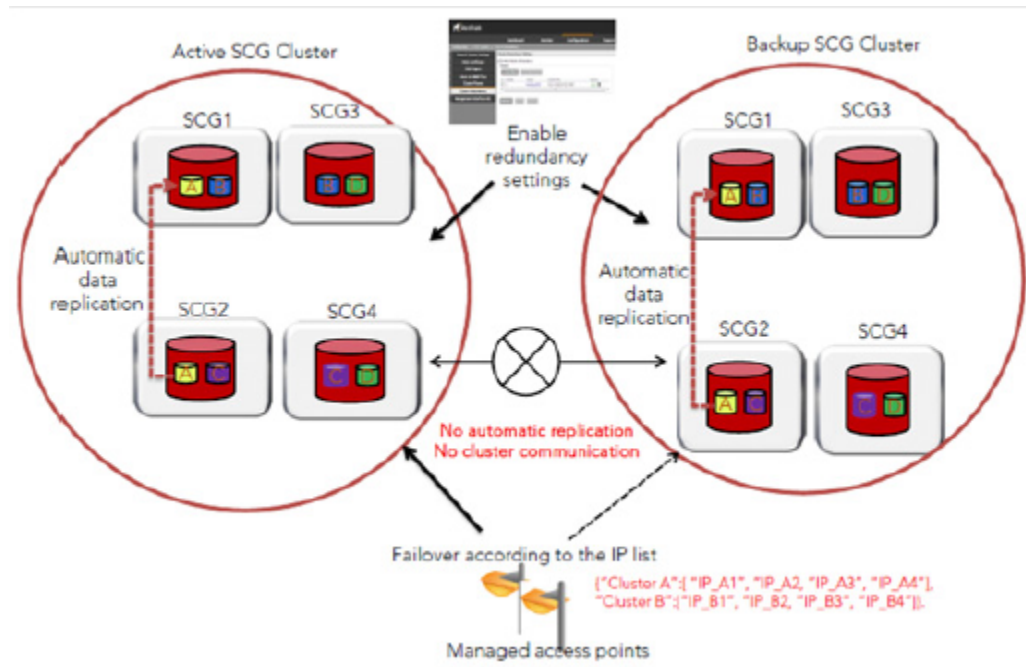
Figure 117: Configuring data planes

## Configuring Cluster Redundancy

If you have multiple clusters on the network, you can configure cluster redundancy to enable APs managed by a particular cluster to fail over automatically to another cluster if their parent cluster goes out of service or becomes unavailable.

Before you configure cluster redundancy, take note of the following:

- Cluster redundancy is disabled by default.
- Only super administrators have the capability to configure the cluster redundancy settings.
- To configure cluster redundancy, you will need to retrieve the IP addresses assigned to the control interfaces of all nodes on clusters that you want to configure.



**Figure 118: Cluster redundancy**

Follow these steps to configure redundancy for a cluster on the network.

1. Go to **Configuration > Cluster Planes**.
2. Select the **Enable Cluster Redundancy** check box.
3. Click the **Create New** button to create a record for a failover cluster.  
The **Cluster** form appears.
4. Configure the settings in the **Cluster** form.
  - a) In **Name**, type a name for the cluster (for example, type `Cluster B`).
  - b) Under **Cluster Control IP List**, click the **Create New IP** button.
  - c) In the text box that appears, type the control interface IP address of a node in this cluster.
  - d) Click **Save**.
  - e) Repeat steps b to d for every node in the cluster. If this cluster has two nodes, for example, this cluster control IP list must have two IP addresses. You can add up to four control IP addresses to the list.

## Cluster Redundancy

Enable Cluster Redundancy [?]

Cluster redundancy will not work if node affinity is enabled.

Cluster

The maximum cluster redundancy list only be 3

Create New Delete Selected

Priority	Name	Control IPs

**Cluster**

Name: \*

Cluster Control IP list

Control IP \*  Add Cancel

No. ▲	Control IP

OK Cancel

**Figure 119: Use the Cluster form to set the cluster control IP addresses**

5. Click **Apply** in the **Cluster** form to save the cluster control IP list.
6. To add another cluster control IP list (for example, for Cluster C), click **Create New**.

You can add up to four cluster control IP lists.

7. Click **Apply** on the **Cluster Redundancy Settings** page.

You have completed configuring cluster redundancy.

**NOTE:** After configuring redundancy for a cluster, Ruckus Wireless strongly recommends backing up the controller configuration.

### How Cluster Redundancy Works

The following simplified scenario describes how cluster redundancy works and how managed APs fail over from one controller cluster to another.

1. After you enable and configure cluster redundancy on the controller, managed APs obtain the updated configuration (which now includes the failover settings) from the controller. If you have two clusters, for example, managed APs will obtain a failover list similar to the following:

```
{ "Cluster A": [ "IP_A1", "IP_A2", "IP_A3", "IP_A4" ], "Cluster B": [ "IP_B1", "IP_B2", "IP_B3", "IP_B4" ] }
```

2. If Cluster A goes out of service or becomes unavailable, APs managed by Cluster A will attempt to connect to the IP addresses (one node at a time) specified for Cluster A.
3. If managed APs are unable to connect to the IP addresses specified for Cluster A, they will attempt to connect to the IP addresses (one node at a time) specified for Cluster B.

4. If managed APs are able to connect to one of the IP address specified for Cluster B, they fail over to Cluster B. Then, they apply the registration rules that have been configured for Cluster B and renew their certificates.

**NOTE:** The second cluster to which APs fail over must have sufficient license seats to accommodate the new APs that it will be managing. If the second cluster has insufficient license seats, the failover will be unsuccessful.

After the APs apply the registration rules and renew their certificates, the failover process is complete. These APs will continue to be managed by the failover cluster until you restore them to the original cluster (rehome) manually.

## Rehoming Managed APs

Rehoming is the process of returning the APs that have failed over to the second cluster back to their original cluster (once it becomes available). Rehoming must be done manually. APs that have failed over will continue to be managed by the failover cluster until you rehome them.

Rehoming APs must be done on a per-zone basis. Follow these steps to rehome managed APs to the original cluster.

1. Go to **Configuration > AP Zones**.
2. From the **AP Zone List**, click the AP zone name that you want to rehome.  
The **AP Zone Configuration Details** page appears.
3. Click the **Switchover Cluster** button.  
The **Switchover Cluster** dialog box appears.
4. From the drop-down menu, select the cluster to which you want the AP zone to switch over (for example, the original cluster to which APs in this zone belonged).
5. Click **Apply**.

You have completed rehoming the APs in the zone.

## Configuring Network Management

This section covers:

### Configuring the SNMPv2 and SNMPv3 Agents

The controller supports the Simple Network Management Protocol (SNMP v2 and v3), which allows you to query controller information, such as system status, AP list, AP zones, etc., and to set a number of system settings using a Network Management System (NMS) or SNMP MIB browser.

You can also enable SNMP traps to receive immediate notifications for possible AP and system issues.

The procedure for enabling the internal SNMP agents depends on whether your network is using SNMPv2 or SNMPv3. SNMPv3 mainly provides security enhancements over the earlier version, and therefore requires you to enter authorization passwords and encryption settings, instead of simple clear text community strings.



Both SNMPv2 and SNMPv3 can be enabled at the same time. The SNMPv3 framework provides backward compatibility for SNMPv1 and SNMPv2c management applications so that existing management applications can still be used to manage the controller with SNMPv3 enabled.

This section covers the following topics:

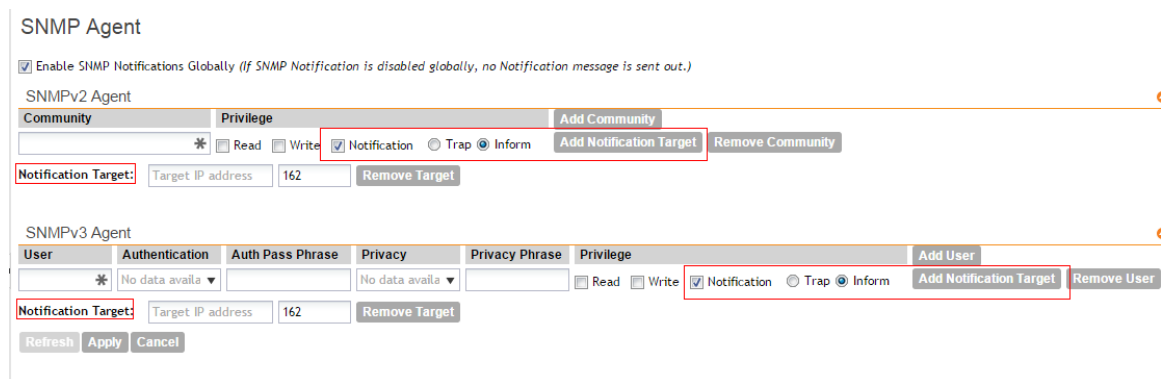
### Enabling Global SNMP Notifications

By default, the global SNMP notification setting is disabled, which means that the controller will be unable to send out notifications, even if you enabled the SNMPv2 and SNMPv3 agents to send out notifications.

Follow these steps to enable global SNMP notifications.

1. Go to the **Configuration > System > SNMP Agent**.  
The **SNMP Agent** page appears.
2. Select the **Enable SNMP Notifications Globally** check box.
3. Click **Apply**.

A message appears, confirming that you have updated the global notification settings.



**Figure 120: The SNMP Agent section**

### Configuring the SNMPv2 Agent

Follow these steps to configure the SNMPv2 agent.

1. In the **SNMPv2 Agent** section, click **Add Community**.  
Options for adding a community appear.
2. Configure the read-only community settings by following these steps:
  - a) In the text box under **Community**, type the read-only community string (for example, public).  
Applications that send SNMP Get-Requests to the controller (to retrieve information) will need to send this string along with the request before they will be allowed access.
  - b) Under **Privilege**, select the check boxes for the privileges that you want to grant to this community.  
A read-only community is typically granted the Read privilege. A read-write community is typically granted the Read and Write privileges. Available privileges include:

- **Read**
- **Write**
- **Notifications**
- **Trap:** Select this privilege if you want to send SNMP trap notifications for this community. To add a trap target, click **Add Notification Target**, and then configure the following options (required) that appear below:
- **Notification Target :** Type the IP address and server port of the SNMP notification server on the network.
- **Inform:** Select this option if you want to send SNMP notifications for this community. To add a trap target, click **Add Notification Target**, and then configure the options.

3. Click **Add Community** again.

A second set of configuration options for adding a community appears.

4. Configure the read-write community settings by following these steps:

- a) In the text box under **Community**, type the read-write community string (for example, `private`).

Applications that send SNMP Set-Requests to the controller (to set certain SNMP MIB variables) will need to send this string along with the request before they will be allowed access. The default value is `private`.

- b) Under **Privilege**, select the check boxes for the privileges that you want to grant to this community.

5. Click **Apply**.

You have completed configuring the communities for the SNMPv2 agent. To add another community, click **Add Community** again, and then repeat the procedure above.

SNMPv2 Agent

Community	Privilege		
<input type="text"/>	<input checked="" type="checkbox"/> Read <input type="checkbox"/> Write <input checked="" type="checkbox"/> Notification <input checked="" type="radio"/> Trap <input type="radio"/> Inform	<b>Add Community</b>	<b>Add Notification Target</b>
<b>Notification Target:</b>	<input type="text" value="Target IP address"/>	<input type="text" value="162"/>	<b>Remove Target</b>
<input type="text"/>	<input type="checkbox"/> Read <input checked="" type="checkbox"/> Write <input checked="" type="checkbox"/> Notification <input type="radio"/> Trap <input checked="" type="radio"/> Inform	<b>Add Notification Target</b>	<b>Rem</b>
<b>Notification Target:</b>	<input type="text" value="Target IP address"/>	<input type="text" value="162"/>	<b>Remove Target</b>

Figure 121: The SNMPv2 Agent section

### Configuring the SNMPv3 Agent

The controller supports the Simple Network Management Protocol (SNMP v2 and v3), which allows you to query controller information, such as system status, AP list, AP zones, etc., and to set a number of system settings using a Network Management System (NMS) or SNMP MIB browser.

Follow these steps to configure the SNMPv3 agent.

1. In the **SNMPv3 Agent** section, click **Add User**.  
Options for adding a user appear.
2. Under **User**, type a user name between 1 and 31 characters.
3. Under **Authentication**, select one of the following authentication methods:
  - **None**: Use no authentication.
  - **MD5**: Message-Digest algorithm 5, message hash function with 128-bit output.
  - **SHA**: Secure Hash Algorithm, message hash function with 160-bit output.
4. Under **Auth Pass Phrase**, type a pass phrase between 8 and 32 characters in length.
5. Under **Privacy**, select one of the following privacy methods:
  - **None**: Use no privacy method.
  - **DES**: Data Encryption Standard, data block cipher.
  - **AES**: Advanced Encryption Standard, data block cipher.
6. Under **Privacy Phrase** (active only if you selected either DES or AES above), enter a privacy phrase between 8 and 32 characters in length.
7. Under **Privilege**, select the check boxes for the privileges that you want to grant to this community.

A read-only community is typically granted the **Read** privilege, whereas a read-write community is granted the **Read** and **Write** privileges. Available privileges include:

- **Read**
- **Write**
- **Notification**
- **Trap**: Select this privilege if you want to send SNMP trap notifications for this community. When this check box is selected, the **Add Notification Target** button becomes active. Click **Add Notification Target**, and then configure the following settings (required):
  - **Notification Target**: Type the IP address and server port of the SNMP trap server on the network.
- **Inform**: Select this option if you want to send SNMP notifications for this community.

To add a trap target, click **Add Notification Target**, and then configure the options.

8. Repeat the steps above to create as many SNMPv3 agent users as you require.
9. Click **Apply**.

You have completed configuring the SNMPv3 agent settings.

The screenshot shows the 'SNMPv3 Agent' configuration page. It features a table with columns for 'User', 'Authentication', 'Auth Pass Phrase', 'Privacy', 'Privacy Phrase', and 'Privilege'. Below the table, there are 'Add User', 'Add Notification Target', and 'Remove User' buttons. The 'Add User' button is highlighted. Below the table, there are three 'Notification Target' sections, each with a 'Target IP address' field and a '162' port field, and a 'Remove Target' button. At the bottom, there are 'Refresh', 'Apply', and 'Cancel' buttons.

User	Authentication	Auth Pass Phrase	Privacy	Privacy Phrase	Privilege	
	No data availa		None		<input checked="" type="checkbox"/> Read <input type="checkbox"/> Write <input checked="" type="checkbox"/> Notification <input checked="" type="radio"/> Trap <input type="radio"/> Inform	Add User
	No data availa				<input type="checkbox"/> Read <input checked="" type="checkbox"/> Write <input checked="" type="checkbox"/> Notification <input checked="" type="radio"/> Trap <input type="radio"/> Inform	Add Notification Target Remove User
	No data availa				<input type="checkbox"/> Read <input checked="" type="checkbox"/> Write <input checked="" type="checkbox"/> Notification <input checked="" type="radio"/> Trap <input type="radio"/> Inform	Add Notification Target Remove User

Notification Target: Target IP address 162 Remove Target

Notification Target: Target IP address 162 Remove Target

Notification Target: Target IP address 162 Remove Target

Refresh Apply Cancel

Figure 122: SNMPv3 Agent section

## Sending SNMP Traps and Email Notifications for Events

By default, the controller saves a record of all events that occur to its database. You can configure the controller to also send SNMP traps and email notifications for specific events whenever they occur.

**NOTE:** Verify that global SNMP traps are enabled to ensure that the controller can send SNMP traps for alarms. For information on how to enable global SNMP traps, refer to [Enabling Global SNMP Notifications](#) on page 233.

**NOTE:**

You can also manually trigger SNMP traps without generating events using CLI. You can use the `#trigger-trap <event code>` command to trigger traps for respective events with their default attributes.

You can acquire the status of a specific client MAC address by using the query RUCKUS-CTRL-MIB. For more information, see the *SmartZone SNMP MIB Reference Guide*.

Follow these steps to configure the controller to send traps and email notifications for events.

1. Go to **Configuration > System**.

2. On the sidebar, click **Event Management**.

If Event Management is not visible on the sidebar, click **Network Management** to expand its submenu, which contains the **Event Management** link.

The **Event Management** page appears.

3. In the **Email Notification** section, select the **Enable** check box, and then type an email address or email addresses in the **Mail To** box.

If you want to send notifications to multiple recipients, use a comma to separate the email addresses.

4. In the **Events** section, go over the table and select the events for which you want to send traps or email notifications (or both).

a) If you know the event code, event type, or description, type the full or partial text into the search box on the upper-right hand corner of the table, and then click the magnifying glass (search) icon.

b) If you want to select all events, click the check box before the **Code** table heading.

**NOTE:** By default, the **Events** table displays up to 20 events per page. If you are enabling SNMP traps and email notifications for 10 or more events, Ruckus Wireless recommends changing the number of events shown per page. To do this, scroll down to the bottom of the page, and then change the value for Show to 250 (maximum).

5. After you have selected all of the events for which you want to send traps or email notifications, scroll up to the beginning of the **Events** table, and then click **Enable**.

A submenu appears and displays the following links:

- **Enable SNMP Notification:** Click this link to enable SNMP trap notifications for all selected events.

- **Enable Email:** Click this link to enable email notifications for all selected events.
- **Enable DB Persistence:** Click this link to enable saving of all selected events to the controller database. If an event is already currently enabled, it will stay enabled after you click this link.

A confirmation message appears.

6. Click **Yes**.

**NOTE:** You can only enable one of these three notification options at a time (for example, SNMP trap notifications only). If you want to enable another option, repeat steps 5 and 6.

You have completed enabling a notification option for the selected events.

**Event Management**

Configure the system to save events to the database or to trigger SNMP traps and email notifications. You can configure the system to manage each event differently.

**Email Notification**

The SMTP server is currently disabled. You must enable and configure the SMTP server so notification emails can be delivered successfully.

Notification Email for Events:  Enable

Mail To:

Use commas to separate multiple email addresses.

Refresh Apply Cancel

**Events**

Refresh Enable Disable Search terms:  Include all terms Include any of these terms

Code	Severity	Category	Type	Description	SNMP Trap	Email	DB Persistence
101	Informational	AP Communication	AP discovery...	This event occurs when AP sends a discovery request to the SCG successfully.	<input type="checkbox"/>	<input type="checkbox"/>	<input checked="" type="checkbox"/>
103	Informational	AP Communication	AP managed	This event occurs when AP is approved by the SCG.	<input type="checkbox"/>	<input type="checkbox"/>	<input checked="" type="checkbox"/>
105	Minor	AP Communication	AP rejected	This event occurs when AP is rejected by the SCG.	<input checked="" type="checkbox"/>	<input type="checkbox"/>	<input checked="" type="checkbox"/>
106	Informational	AP Communication	AP firmware ...	This event occurs when AP successfully updates its firmware.	<input type="checkbox"/>	<input type="checkbox"/>	<input checked="" type="checkbox"/>
107	Major	AP Communication	AP firmware ...	This event occurs when the AP fails to update its firmware.	<input checked="" type="checkbox"/>	<input type="checkbox"/>	<input checked="" type="checkbox"/>
108	Informational	AP Communication	Updating AP f...	This event occurs when AP is updating its firmware.	<input type="checkbox"/>	<input type="checkbox"/>	<input checked="" type="checkbox"/>
109	Informational	AP Communication	Updating AP ...	This event occurs when the AP is updating its configuration.	<input type="checkbox"/>	<input type="checkbox"/>	<input checked="" type="checkbox"/>
110	Informational	AP Communication	AP confourat...	This event occurs when the AP has successfully updated its confouration.	<input type="checkbox"/>	<input type="checkbox"/>	<input checked="" type="checkbox"/>

Figure 123: Selecting all events on the Event Management page

**Enabling or Disabling Notifications for a Single Event**

Follow these steps to enable or disable notifications for a single event.

1. Go to **Configuration > System**.
2. On the sidebar, click **Event Management**.
3. Under **Events**, locate the event for which you want to enable or disable notifications.
4. Click the event code.  
The **Edit Event [Event Code]** form appears.
5. Select the check box for a notification type to enable it, or clear the check box to disable it.  
Options include:
  - **SNMP Notification**
  - **Email Notification**
  - **DB Persistence**

6. Click **Apply**.

You have completed enable or disabling notifications for a single event.

**Edit Event: [101]**

<b>Event Code:</b>	101
<b>Event Severity:</b>	Informational
<b>Event Category:</b>	AP Communication
<b>Description:</b>	This event occurs when AP sends a discovery request to the SCG successfully.
<b>SNMP Notification:</b>	<input checked="" type="checkbox"/> Enable
<b>OID:</b>	1.3.6.1.4.1.25053.2.10.1.20
<b>Email Notification:</b>	<input type="checkbox"/> Enable
<b>DB Persistence:</b>	<input checked="" type="checkbox"/> Enable

Apply
Cancel

**Figure 124: Select or clear check boxes to enable or disable notifications**

### Viewing Enabled Notifications for Events

Follow these steps to view the notification types that are enabled for events.

1. Go to **Configuration > System**.
2. On the sidebar, click **Event Management**.
3. Scroll down to the bottom of the page, and then select **250** in **Show**.

The page refreshes, and then displays up to 250 events.

4. Check the **SNMP Notification**, and **DB Persistence** and columns on the right side of the table. A check mark under each column indicates that the notification option is enabled for the event.

To view the notification options that are enabled for the events on the next page, click **>>** at the bottom of the table. The page refreshes, and then displays the remaining events.

### Configuring Event Thresholds

An event threshold defines a set of conditions related to the controller hardware that need to be met before the controller triggers an event. You can accept the default threshold values or you can update the threshold values to make them more suitable to your deployment or controller environment.

Follow these steps to configure the threshold for an event.

1. Go to **Configuration > System**.
2. On the sidebar, click **Network Management > Event Threshold**.

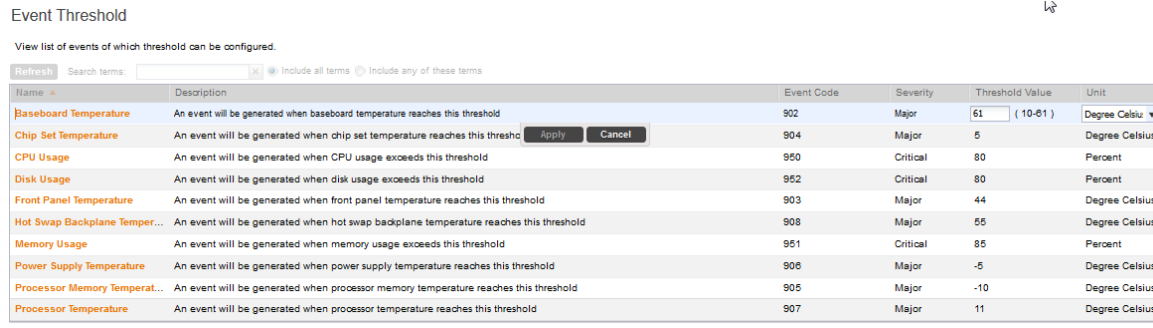
The **Event Threshold** page appears and displays the list of events with configurable thresholds (see [Table 13: List of hardware events with configurable thresholds](#) on page 239), including the event code, severity level, default value and accepted range, and unit of measurement for each event.

3. Locate the event threshold that you want to configure.
4. Click the event name under the **Name** column.

The threshold value for the event become edits. Next to the threshold value, the acceptable range is shown.

5. Edit the threshold value.
6. Click **Apply**.

Repeat the same procedure to edit the threshold of another event.



**Figure 125: Configuring the CPU Usage event threshold**

### Events with Configurable Thresholds

Controller hardware events for which you can configure the event thresholds, including their default values and acceptable ranges.

**Table 13: List of hardware events with configurable thresholds**

Event	Event Code	Severity	Threshold Value	Unit
CPU Usage	950	Critical	Default: 80 Range: 60 to 90	Percent
Disk Usage	952	Critical	Default: 80 Range: 60 to 90	Percent
Memory Usage	951	Critical	Default: 80 Range: 60 to 90	Percent
Baseboard Temperature	902	Major	Default: 61 Range: 10 to 61	Degree Celsius
Chip Set Temperature	904	Major	Default: 5 Range: -20 to 5	Degree Celsius
Front Panel Temperature	903	Major	Default: 44 Range: 5 to 44	Degree Celsius

Event	Event Code	Severity	Threshold Value	Unit
Hot Swap Backplane Temperature	907	Major	Default:55 Range: 9 to 55	Degree Celsius
Power Supply Temperature	906	Major	Default: -5 Range:	Degree Celsius
Processor Memory Temperature	905	Major	Default: -10 Range: -20 to 5	Degree Celsius
Processor Temperature	907	Major	Default: 55 Default: 9 to 55	Degree Celsius

### Controlling Access to the Management Interfaces

Management interfaces, which include the web interface and the command line interface, are the primary methods through which you configure the controller and its managed devices. Access to these interfaces is password-protected.

To prevent unauthorized devices from accessing these management interfaces, you can create ACLs. Management interface ACLs in the controller are whitelist (as opposed to blacklists), which are lists that contain only the IP addresses or IP address range that are allowed access to the management interfaces.

Follow these steps to configure the management interface ACL.

1. Go to **Configuration > System**.
2. On the sidebar, click **Management Interface ACL**.
3. In **Access Control of Management Interface**, click the **Enable** option.
4. In **Name**, type a name for this ACL.
5. In **Description**, type a brief description for this ACL.
6. In **Type**, select one of the following options, and then provide the required information:

**NOTE:** Depending on the system IP mode that you selected, you can enter either IPv4 or IPv6 addresses (or both).

- **Single IP:** Type the IP address that you want to allow access to the management interfaces. For example, you can type 192.168.1.1 (IPv4) or ::123 (IPv6).
- **IP Range:** Type the IP address range that you want to allow access to the management interfaces by filling out the **Start IP Address** and the **End IP Address** boxes. For example, you can type 192.168.1.2 - 192.168.1.20 (IPv4) or ::123 - ::456 (IPv6).
- **Subnet:** Fill out the Network Address and Subnet Mask boxes. For example, you can type 192.168.1.1/255.255.255.0 or 192.168.1.1/24.

7. Click **Create New**.

The page refreshes, and then the ACL that you created appears in the ACL list.



8. Create additional ACLs as needed.
9. Click **Apply**.

You have completed creating ACLs to control access to the management interfaces.

### Management Interface ACL

Access Control List

Only IP addresses included in this access control list are allowed to access the controller's management interface.

Create New Delete Selected

Name	Description
------	-------------

**Management Interface Access Control Rule**

Name: \*

Description:

Type: \*  Single IP  IP Range  Subnet

Single IP

IP Address: \*

OK Cancel

Show 20

Access Control of Management Interface: \*  Enable  Disable

Refresh Apply Cancel

Figure 126: The Management Interface ACL page

## Configuring Hosted AAA Services

SIM Authentication module enables you to provide IP-based services such as public WLAN access, and Unlicensed Mobile Alliance (UMA) and Femtocell access to subscribers, which is appropriate for GSM (Global System for Mobile Communications) infrastructure.

SIM authentication provides AAA services for EAP 802.1X and non-802.1X hotspots and Unlicensed Mobile Access (UMA) networks. Along with this, a user can be offered secure hotspot access via EAP 802.1X and Extensible Authentication Protocol - Subscriber Identity Module (EAP-SIM) or Extensible Authentication Protocol - Authentication and Key Agreement (EAP-AKA) user authentication.

SIM authentication module extends mobile services over IP access networks for UMA environments, providing the same mobile identity on unlicensed wireless networks as on mobile networks, and enables roaming and handover between networks.

This section covers:

## EAP-SIM Configuration

The SIM authentication module handles EAP-SIM authentication for clients using SIM cards. Follow these steps to configure the EAP-SIM module.

1. In **EAP-SIM Configuration**, verify that the **Enable** option is selected (default). This will enable clients using GSM SIM cards to authenticate with AAA services.
2. In the **EAP-SIM Configuration** section, configure the following settings for EAP-SIM access:
  - **User ID Privacy Support**: Click this option to add an **Active Secret Key**.
  - **Fast Reauthentication Support**: Click this option to enable fast reauthentication, which is useful when SIM authentication happens frequently.
  - **Reauthentication Realm**: Type the reauthentication realm. The default realm is the realm from the permanent identity of the client.
  - **Max Successive Reauthentication**: Set the number of allowed reauthentication attempts before requesting fresh triplets and performing a complete authentication. The default is 256. If you enter 0, reauthentication identities will not be generated.
3. In the **EAP-SIM Secret Key Configuration** section, configure the secret keys, which are used to encrypt the permanent identity to generate pseudonym and reauthentication identity.
  - a) Click the **Create New** option to add a key.
  - b) In **Key**, type any text string up to 32 characters.

If you do not specify a secret, pseudonyms will not be generated. If you change this value, all pseudonyms assigned to currently authenticated clients will be invalidated and they will require reauthentication.
  - c) Click **Save**.
4. In the **EAP-SIM Cache Cleanup Configuration** section, configure the cleanup time for the cache to be cleaned. At cleanup time, all the cache entries (except the ones which were used during the last history length) will be deleted.
  - a) In **Cache**, click the **Enable** option to enable cache cleanup.

This option is disabled by default.
  - b) In **Cache Cleanup Time**, set the time (hour and minute) when cache cleanup will be triggered.
  - c) In **Cache History Length**, set the maximum size of cache entries. The default is 256.
5. Click **Apply**.

You have completed configuring EAP-SIM based authentication using AAA server.

EAP-SIM Configuration: \*  Enable  Disable

---

**EAP-SIM Configuration**  
EAP-SIM configuration parameters define the basic settings for the EAP-SIM access method.

User ID Privacy Support:  Enable  Disable      Reauthentication Realm:

Fast Reauthentication Support:  Enable  Disable      Max Successive Reauthentication:

Active Secret Key:

---

**EAP-SIM Secret Key Configuration**  
EAP-SIM secret keys are used to encrypt the permanent identity to generate pseudonym and reauthentication identity.

<input type="checkbox"/>	Key Number	Key	Created On	Actions

---

**EAP-SIM Cache Cleanup Configuration**  
The cache cleanup parameters define the time when the cache is cleared. At cleanup time, all of the cache entries (except the ones that were used during the last history length) are deleted.

Cache: \*  Enable  Disable

Cache Cleanup Time: \*  Hours  Minutes

Figure 127: Configuring EAP-SIM authentication

## EAP-AKA Configuration

The AKA authentication module handles EAP-AKA authentication for clients using USIM cards. Follow these steps to the EAP-AKA module.

1. In **EAP-AKA Configuration**, verify that the **Enable** option is selected (default).  
This will enable clients using 3G USIM cards to authenticate with AAA services.
2. In **EAP-AKA Configuration** section, configure the following settings for EAP-AKA access:
  - **User ID Privacy Support:** Click this option to add an **Active Secret Key**.
  - **Fast Reauthentication Support:** Click this option to enable fast reauthentication, which is useful when AKA authentication happens frequently.
  - **Reauthentication Realm:** Type the reauthentication realm. The default realm is the realm from the permanent identity of the client.
  - **Max Successive Reauthentication:** Set the number of allowed reauthentication attempts before requesting fresh triplets and performing a complete authentication. The default is 256. If you enter 0, reauthentication identities will not be generated.
3. In the **EAP-AKA Secret Key Configuration** section, configure the secret keys, which are used to encrypt the permanent identity to generate pseudonym and reauthentication identity.
  - a) Click the **Create New** option to add a key.
  - b) In **Key**, type any text string up to 32 characters.  
  
If you do not specify a secret, pseudonyms will not be generated. If you change this value, all pseudonyms assigned to currently authenticated clients will be invalidated and they will require reauthentication.
  - c) Click **Save**.
4. In the **EAP-AKA Cache Cleanup Configuration** section, configure the cleanup time for the cache to be cleaned. At cleanup time, all the cache entries (except the ones which were used during the last history length) will be deleted.

- a) In **Cache**, click the **Enable** option to enable cache cleanup.  
This option is disabled by default.
- b) In **Cache Cleanup Time**, set the time (hour and minute) when cache cleanup will be triggered.
- c) In **Cache History Length**, set the maximum size of cache entries. The default is 256.

5. Click **Apply**.

You have completed configuring EAP-AKA based authentication using AAA server.

### EAP-AKA

EAP-AKA Configuration:  Enable  Disable

EAP-AKA Configuration

EAP-AKA configuration parameters define the basic settings for the EAP-AKA access method.

User ID Privacy Support:  Enable Reauthentication Realm:

Fast Reauthentication Support:  Enable Max Successful Reauthentication:

Active Secret Key:

EAP-AKA Secret Key Configuration

EAP-AKA secret keys are used to encrypt the permanent identity to generate pseudonym and reauthentication identity.

<input type="checkbox"/>	Key Number	Key	Created On	Actions

EAP-AKA Cache Cleanup Configuration

The cache cleanup parameters define the time when the cache is cleared. At cleanup time, all of the cache entries (except the ones that were used during the last history length) are deleted.

Cache:  Enable  Disable

Cache Cleanup Time:  Hours  Minutes

Cache History Length:

Figure 128: Configuring EAP-AKA authentication

In this chapter:

- [Overview of Management Domains](#)
- [Viewing a List of Management Domains](#)
- [Creating a New Management Domain](#)
- [Deleting a Management Domain](#)
- [Assigning an Administrator Account to a Role](#)

## Overview of Management Domains

Management domains allow you to segment managed access points into different groups and assign them to different AP zones and administrators. By default, a primary management domain named Administration Domain exists.

You can create additional subdomains under the Administration Domain and assign access points to these subdomains.

## Viewing a List of Management Domains

Management domains allow you to segment managed access points into different groups and assign them to different AP zones and administrators.

Follow these steps to view a list of existing management domains.

1. Go to **Configuration > Management Domains**.  
The **Management Domain: Administration Domain** page appears.
2. To view a summary of the administration domain, check the **Summary** section at the top of the page.

This section displays the following information about the administration domain:

- **Domain Name**
  - **Description**
  - **Created By**
  - **Created On**
  - **# of Zones** (more details in the AP Zones in Management Domain section)
  - **# of APs**
  - **# of Administrators** (more details in the Administrators section)
  - **# of Subdomains**
3. To view a list of subdomains that have been created, scroll down to the **Subdomains** section.  
The table in this section shows a list of existing subdomains, as well as the following information for each subdomain:

- Domain Name
- Description
- Created By
- Created On
- # of Zones
- # of APs
- # of Administrators
- # of Subdomains
- Actions that you can perform

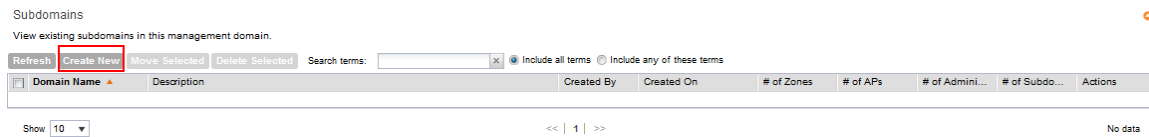


Figure 129: View list of domains

## Creating a New Management Domain

Management domains allow you to segment managed access points into different groups and assign them to different AP zones and administrators.

Follow these steps to create a new management domain.

1. In the Subdomains section, click **Create New**.

The **Create New Management Domain** form appears.

2. In **Domain Name**, type a name for the management domain that you are creating.
3. In **Description**, type a short description for the management domain.
4. Click **OK**.
5. The page refreshes, and then the management domain that you created appears under the **Subdomains** table.

Management Domains: Administration Domain

Management domains can contain multiple zones or other management domains. Administrators can be assigned different roles within each management domain.

General Information		Summary	
Domain Name	Administration Domain	# of Zones	2
Description	Administration Domain	# of APs	2
Created By	admin	# of Administrators	1
Created On	2015/10/07 14:01:50	# of Subdomains	0

AP Zones in Management Domain

View existing Ruckus AP zones in this management domain.

Refresh Move Selected Search terms:  Include all terms Include any of these terms

Zone Name	Management Dom...	Description	AP Firmware	Created By	Created On	Actions
Staging Zone	Administration Do...	Staging Zone		admin	2015/10/07 14:01:50	
zone1	Administration Do...		3.2.0.0.548	admin	2015/10/09 13:00:12	

Show 10 << | 1 | >> 2 total records

Administrators

View existing administrators that have been enabled for this management domain.

Refresh Add Account & Assign Role Remove Selected Search terms:  Include all terms Include any of these terms

Account Name	Role Name	Real Name	Job Title	Contact Pho...	Email Address	Actions
admin	Super Admin					

Show 10 << | 1 | >> 1 total records

Figure 130: The Create New Management Domain form

## Deleting a Management Domain

If you do not require a management domain, you can delete it. When you delete a management domain, the access points attached to the domain are also deleted.

Before you can delete a management domain, you must move all AP zones that belong to it to another management domain.

Follow these steps to delete an existing management domain.

1. In the Subdomains section, locate the management domain that you want to delete.
2. Under the **Actions** column, click the icon that is in the same row as the management domain name.

A confirmation message appears.

3. Click **Yes**.

You have completed deleting a management domain.

To delete multiple management domains simultaneously, select the check boxes for the management domains, and then click the **Delete Selected** button. When the confirmation message appears, click **Yes**.

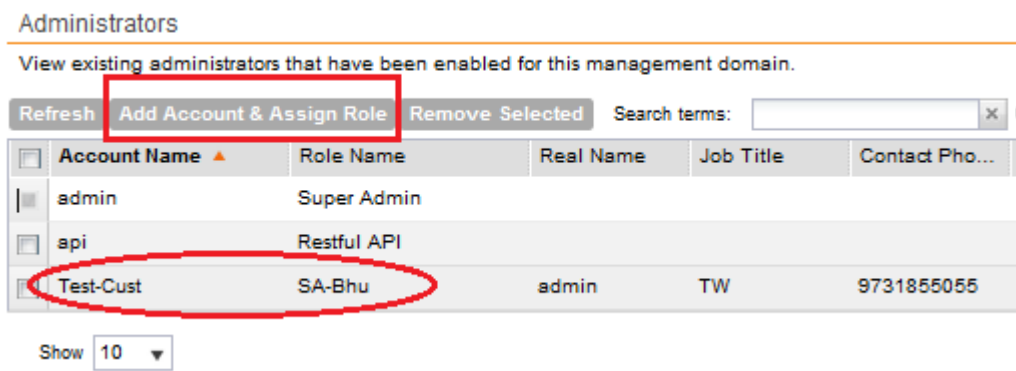
## Assigning an Administrator Account to a Role

You can create Administrator Accounts and assign it to a Role provided you associate the Role with a domain it must manage.

Follow these steps to assign an Administrator Account to a Role.

Before performing this task, ensure that you have:

- Created an Administrator Account based on the instructions in [Creating an Administrator Account](#) on page 252
  - Created a Role based on the instructions in [Creating a New Administrator Role](#) on page 252
  - Authenticate the new Administrator Account from the RADIUS server based on the instructions in [Adding a RADIUS Server for Administrators](#) on page 254
1. Go to **Configuration > Management Domains**.  
The **Management Domain: Administration Domain** page appears.
  2. In the **Administrators** section, click **Add Account & Assign Role**.
  3. In **Account Name**, select the account you created.
  4. In **Role Name**, select the role you created.
  5. Click **OK**.



**Figure 131: Assigning Administrator Accounts to Roles in a Management Domain**

6. Login to the controller's management interface with the new account name, e.g. Test-Cust.  
After you login with the new account name, you will see the new user role and account as shown in the figure.



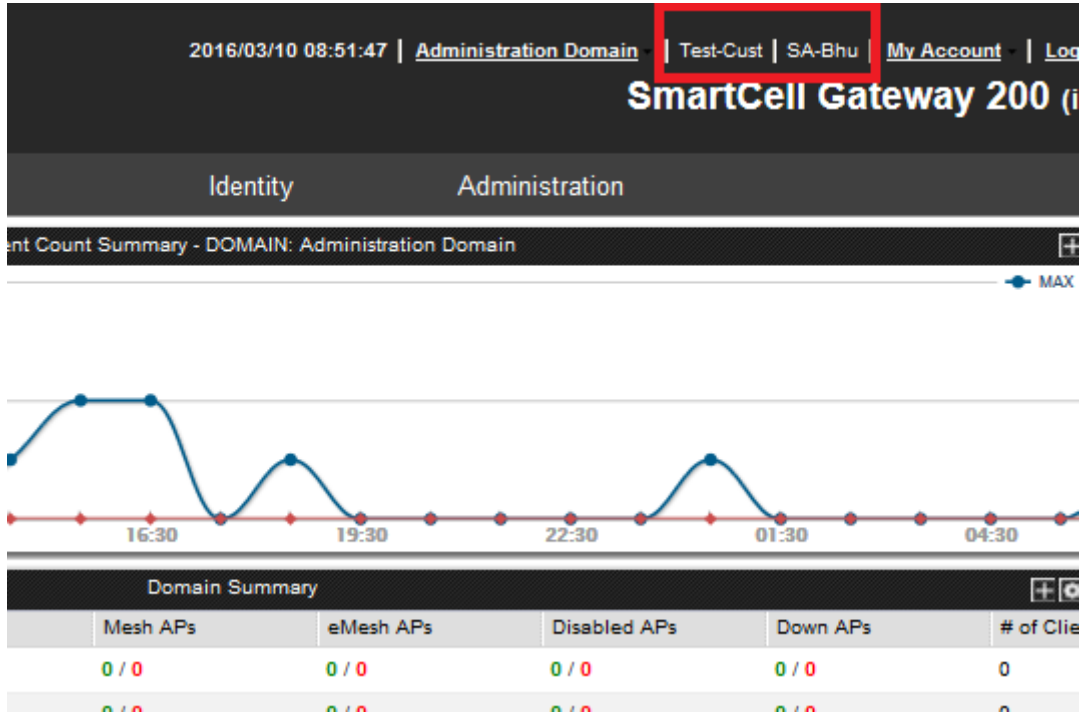


Figure 132: Controller screen after logging in with the new Administrator Account

You have successfully added an Administrator Account to a Management Domain and assigned a Role to it.

# 9

## Managing Administrator Accounts

In this chapter:

- [Overview of Administrator Accounts and Roles](#)
- [Viewing a List of Administrator Accounts, Roles, and RADIUS Servers](#)
- [Creating an Administrator Account](#)
- [Creating a New Administrator Role](#)
- [Editing an Administrator Role](#)
- [Cloning an Existing Administrator Role](#)
- [Adding a RADIUS Server for Administrators](#)
- [Using a Backup RADIUS Server](#)
- [Testing an AAA Server](#)
- [Deleting an Administrator Account, Role, or RADIUS Server](#)

### Overview of Administrator Accounts and Roles

The controller supports the creation of additional administrator accounts. This allows you to share or delegate management and monitoring functions with other members of your organization.

In addition to creating administrator accounts, you can also create administrator roles, which define the tasks that each administrator can perform. You can also add RADIUS servers that you want to use for authorizing and authenticating administrators.

### Viewing a List of Administrator Accounts, Roles, and RADIUS Servers

The controller supports the creation of administrator accounts, roles and Radius servers for authorizing and authenticating administrators.

Follow these steps to view a list of existing administrator accounts, roles and RADIUS servers as seen in the below figure.

**1. Go to **Configuration** > **Administrators**.**

The **Administrator Accounts** lists a table of existing administrator accounts along with their basic details as mentioned below.

**2. Click the account name to view the account details or to edit the account.**

- **Account Name**
- **Real Name**
- **# of Assigned Domains:** The number of domains that this administrator account manages.
- **Job Title**
- **Contact Phone**

- Email Address
- Created By
- Created On
- Actions that you can perform

3. Click the role name to view the role details or to edit the role.

The **Administrator Role** defines the tasks assigned to an administrator. The table lists the existing administrator roles with their basic details as mentioned below.

- Role Name
- Description
- # of Administrators: The number of administrators assigned to a role
- Created By
- Created On
- Actions that you can perform

4. The **RADIUS Servers for Administrators Role** lists the RADIUS servers assigned to an administrator for authorization and authentication.

- AAA Server Name
- Type
- Realms
- Primary Server
- Secondary Server
- Created By
- Created On
- Actions that you can perform

The screenshot displays the 'Administrators' configuration page, divided into three main sections:

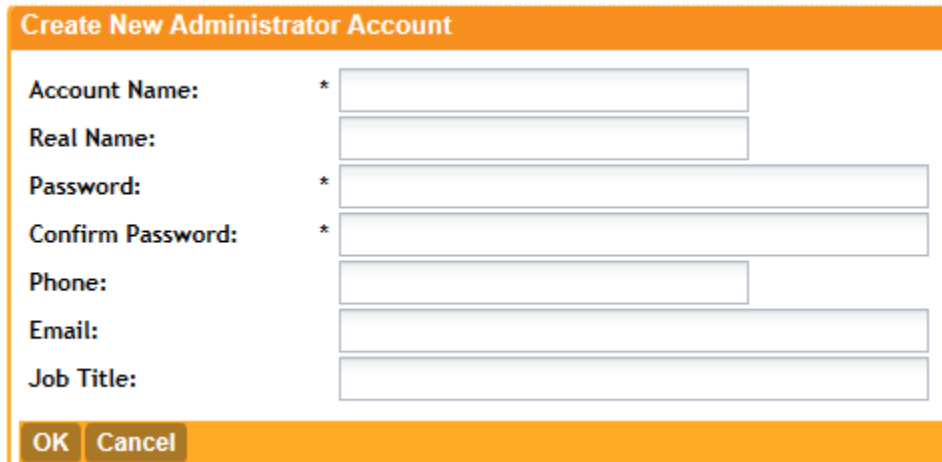
- Administrator Accounts:** A table with one record for the 'admin' account, created by 'admin' on 2015/09/07 15:04:33.
- Administrator Roles:** A table with six records for roles like 'Guest Pass Generator', 'MVNO Super Admin', 'Network Admin', 'Restful API', 'SCG Admin', and 'Super Admin', each with a corresponding number of administrators assigned.
- RADIUS Servers for Administrators:** A table with columns for AAA Server Name, Type, Realms, Primary Server, Secondary S..., Created By, and Created On.

Figure 133: Administrator View of Accounts, Roles and RADIUS Servers

## Creating an Administrator Account

You can create an administrator account to share or delegate management and monitoring functions with members within your organization.

The page refreshes, and then the administrator account that you created appears in the **Administrator Accounts** section.



The screenshot shows a web form titled "Create New Administrator Account" with an orange header. The form contains the following fields:

- Account Name: \* [text input]
- Real Name: [text input]
- Password: \* [password input]
- Confirm Password: \* [password input]
- Phone: [text input]
- Email: [text input]
- Job Title: [text input]

At the bottom of the form are two buttons: "OK" and "Cancel".

Figure 134: The Create New Administrator Account form

1. In the **Administrator Accounts** section, click **Create New**.  
The **Create New Administrator Account** form appears.
2. In **Account Name**, type the name that this administrator will use to log on to the controller.
3. In **Real Name**, type the actual name (for example, John Smith) of the administrator.
4. In **Password**, type the password that this administrator will use (in conjunction with the **Account Name**) to log on to the controller.
5. In **Confirm Password**, type the same password as above.
6. In **Phone**, type the phone number of this administrator.
7. In **Email**, type the email address of this administrator.
8. In **Job Title**, type the job title or position of this administrator in your organization.
9. Click **Create New**.

## Creating a New Administrator Role


An administrator role defines the tasks that an administrator can perform.

Follow these steps to create a new administrator role.

1. In the **Administrator Roles** section, click **Create New**.  
The **Create New Administrator Role** form appears.

2. In **Role Name**, type a name for the administrator role that you are creating.
3. In **Description**, type a short description for the administrator role.
4. In the **Assign Capabilities to Administrator Role** tree (located on the left side of the form), select the administrator capabilities that you want to assign to this role.

If you plan to grant this administrator role most of the capabilities that are available, click **Select All**, and then clear the check boxes for the capabilities that you do not want this role to have.

5. Remember to click the  icon next to each folder to view all capabilities that are included.
6. Click **Create New**.

You have completed creating an administrator role.

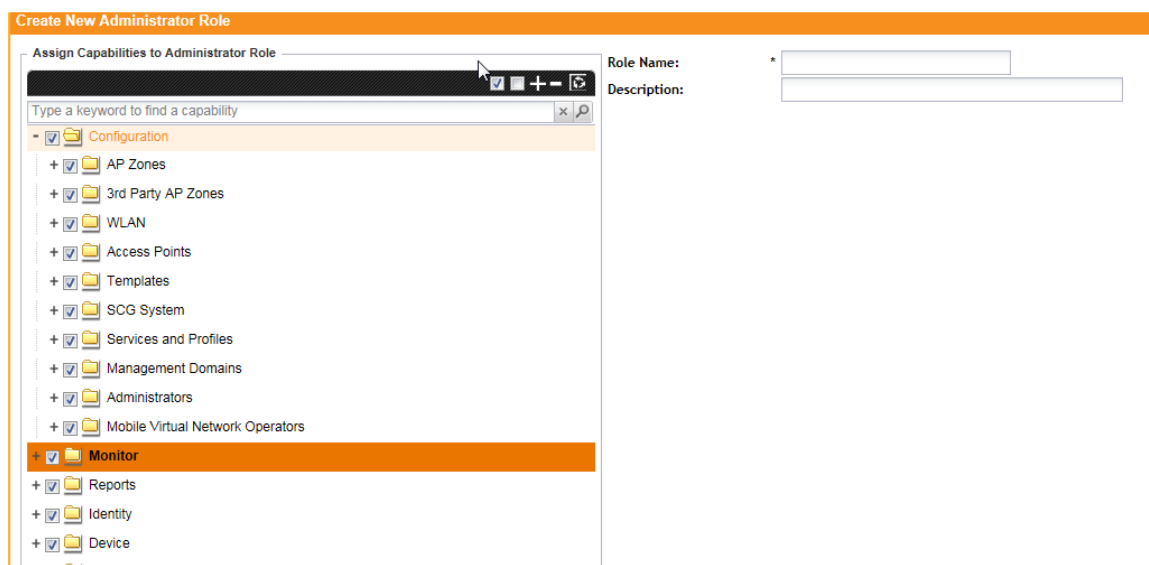


Figure 135: The Create New Administrator Role form

## Editing an Administrator Role

An administrator role defines the tasks that an administrator can perform, and it can be edited.

Follow these steps to edit an existing administrator role.

1. In the **Administrator Roles** section, locate the role that you want to edit.
2. Click the name of the administrator role that you want to edit.

The **Edit Administrator Role** form appears.

3. In the **Assign Capabilities to Administrator Role** tree (located on the left side of the form), add or remove capabilities from the role.

Remember to click the icon next to each folder to view all capabilities that are included.

4. To add a capability, select the check box next to it.

5. To remove a capability, clear the check box next to it.
6. Click **Apply**.

A message appears, confirming that the role has been updated.

7. Click **Yes** to close the message.

You have completed editing an administrator role.

**NOTE:** The system-created administrator account and role, which is present by default on the controller, cannot be edited.

## Cloning an Existing Administrator Role

If you want to create a new administrator role with capabilities that are similar to an existing role, cloning the existing administrator role may be the faster way to create that new role.

You have completed cloning an existing administrator role. Unless you want the new role to have exactly the same capabilities as the original role, you may want to edit it. For the steps on editing the role, refer to [Editing an Administrator Role](#).

1. Follow these steps to clone an existing administrator role.
2. In the **Administrator Roles** section, locate the role that you want to clone.
3. Under the **Actions** column, click the icon that is in the same row as the role that you want to clone.

A dialog appears and prompts you for the name that you want to assign to the clone role. The default name is Clone of [Original Role Name].

4. Type a new name or leave the name as is.
5. Click **Apply**.

The page refreshes, and then the role that you created appears under the **Administrator Roles** section.

## Adding a RADIUS Server for Administrators

You can add a RADIUS server to authenticate administrators.

**NOTE:** If you want to use a primary and secondary RADIUS servers for authenticating administrator, follow the steps in [Using a Backup RADIUS Server for Authenticating Administrators](#).

You have completed adding a RADIUS server for authenticating administrators.

**Create New Administrator RADIUS Server**

Name: \*

Type: \*  RADIUS  TACACS+

Realm: \*   
Multiple realms supported. Use a comma (,) to separate realms (for example, home1,home2).

Backup RADIUS:  Enable Secondary Server

IP Address: \*

Port: \*

Shared Secret: \*

Confirm Secret: \*

OK Cancel

**Figure 136: The Create New Administrator RADIUS Server form**

1. Go to **Configuration > Administrators**.
2. In the RADIUS Servers for Administrators section, click **Create New**.  
The **Create New Administrator RADIUS Server** form appears.
3. In **Name**, type a name for the RADIUS server.
4. In **Type**, select the type of RADIUS server that you are using. Options include:
  - **RADIUS**: Click this option to use a Remote Authentication Dial-In User Service (RADIUS) server on the network for authenticating controller administrators.
  - **TACACS+**: Click this option to use a Terminal Access Controller Access-Control System Plus (TACACS+) server on the network for authentication controller administrators. See [About TACACS+ Support](#) for more information.
5. In **Realm**, type the realm (or realms) to which the RADIUS server belongs.  
If the RADIUS server belongs to multiple realms, use a comma (,) to separate the realm names.
6. Make sure that the **Enable backup RADIUS support** check box is not selected.  
If you want to use a backup RADIUS server, follow the steps in [Using a Backup RADIUS Server](#) instead.
7. In **IP Address**, type the IP address of the RADIUS server.
8. In **Port**, type the UDP port that the RADIUS server is using.  
The default port is 1812.
9. In **Shared Secret**, type the shared secret.
10. Retype the same secret in **Confirm Secret**.
11. Click **Create New**.

### About TACACS+ Support

Terminal Access Controller Access-Control System Plus (TACACS+) is one of the Authentication, Authorization and Accounting protocols that can be used to authenticate controller

administrators.TACACS+ is an extensible AAA protocol that provides customization and future development features, and uses TCP to ensure reliable delivery.

In addition to selecting TACACS+ as the RADIUS type in [Adding a RADIUS Server for Administrators](#), you must also complete the following steps for TACACS+ based authentication to work.

1. Edit the TACACS+ configuration file (`tac.cfg`) on the TACACS+ server to include the service user name.

See the example below.

```
key = test@1234
accounting file = /var/log/tac_acct.log
user = username {
    member = show
    login = cleartext "password1234!"
}
group = show {
    service = super-login {
        user-name = super <<==mapped to the user account in the controller
    }
}
```

2. On the controller web interface, go to the **Configuration > Administrators** page, and then create an administrator account with `super` as the user name.
3. Go to the **Configuration > Management Domains** page, and then assign the `super` administrator account an administrator role.
4. When you add a RADIUS server for administrators (see [Adding a RADIUS Server for Administrators](#)), select **TACACS+** as the authentication type.
5. After you add the RADIUS server for administrators, test it using the account `username@super-login`.

You have completed the configuration steps required to ensure that TACACS+ authentication for administrators work on the controller.

## Using a Backup RADIUS Server

If a backup RADIUS server is available on the network, you can select the **Enable backup RADIUS server support** check box to use the backup server when the primary server is unavailable.

When you select the check box, additional fields appear that you need to fill in.

Follow these steps to enable support for a backup RADIUS server for authenticating administrators.

1. Select the check box next to **Enable backup RADIUS support**.
2. In the **Primary Server** section, fill out the **IP address**, **port number**, and **shared secret** as you did in the previous section.



3. In the **Secondary Server** section, fill out the **IP Address**, **port number** and **shared secret** for the backup server (these fields can neither be left empty nor be the same values as those of the primary server).
4. In the **Failover Policy** section, configure the following settings:
  - **Request Timeout:** Type the timeout period (in seconds) after which an expected RADIUS response message is considered to have failed.
  - **Max Number of Retries:** Type the number of failed connection attempts after which the controller will fail over to the backup RADIUS server.
  - **Reconnect Primary:** Type the number of minutes after which the controller will attempt to reconnect to the primary RADIUS server after failover to the backup server.
5. Click **Apply**.

You have completed adding primary and secondary RADIUS servers for authenticating administrators.

**Edit Administrator RADIUS Server: [RADIUS]**

Name: \* RADIUS

Type: \*  RADIUS  TACACS+

Realm: \* scgLogin123  
Multiple realms supported. Use a comma (,) to separate realms (for example, home1,home2).

Backup RADIUS:  Enable Secondary Server

**Primary Server**

IP Address: \* 134.0.0.2

Port: \* 1812

Shared Secret: \* ●●●●●●

Confirm Secret: \* ●●●●●●

**Secondary Server**

IP Address: \* 144.0.0.2

Port: \* 1812

Shared Secret: \* ●●●●●●

Confirm Secret: \* ●●●●●●

**Failover Policy at NAS**

Request Timeout: \* 3 Seconds

Max Number of Retries: \* 2 Times

Reconnect Primary: \* 5 Minute (1-60)

Apply Cancel

**Edit Administrator RADIUS Server: [TACACS+]**

Name: \* TACACS+

Type: \*  RADIUS  TACACS+

Service: scgLogin  
Multiple services supported. Use a comma (,) to separate services (for example, home1,home2).

IP Address: \* 172.19.10.201

Port: \* 49

Shared Secret: \* ●●●●●●

Confirm Secret: \* ●●●●●●

Apply Cancel

Figure 137: Enabling the backup RADIUS server

## Testing an AAA Server

To ensure that the controller administrators will be able to authenticate successfully with the RADIUS server type that you selected, Ruckus Wireless strongly recommends testing the AAA server after you set it up.

The test queries the RADIUS server for a known authorized user and return groups associated with the user that can be used for configuring roles within the controller. Follow these steps to test an AAA server.

1. Go to **Configuration > Administrators**.
2. Scroll down to the **RADIUS Servers for Administrators** section.
3. Click **Test AAA**.

The **Test AAA Servers** form appears.

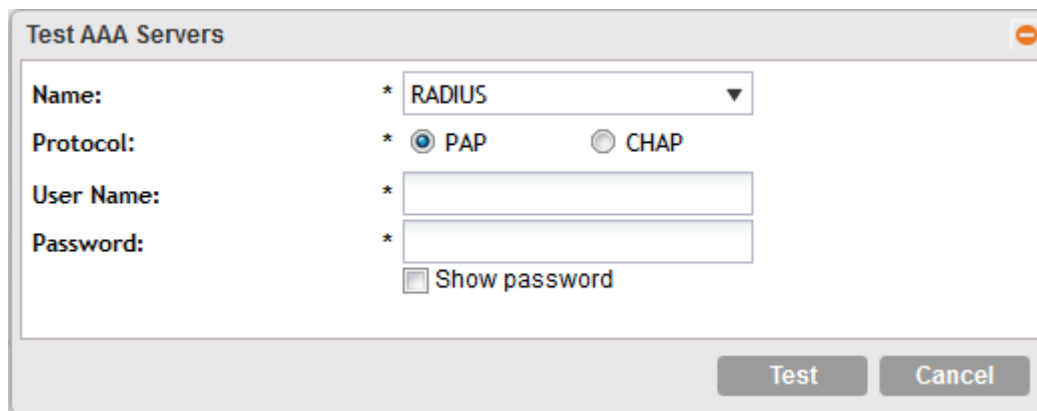
4. In **Name**, select one of the AAA servers that you previous created.
5. In **Protocol**, select the Password Authentication Protocol (PAP), or the Challenge Handshake Authentication Protocol (CHAP) to authenticate the AAA server.
6. In **User Name**, type an existing user name on the AAA server that you selected.
7. In **Password**, type the password for the user name you specified.
8. Click **Test**.

If the controller was able to connect to the authentication server and retrieve the configured groups/attributes, the information appears at the bottom of the page.

If the test was unsuccessful, there are two possible results (other than success) that will be displayed to inform you if you have entered information incorrectly:

- Admin invalid
- User name or password invalid

These results can be used to troubleshoot the reasons for failure to authenticate administrators with an AAA server through the controller.



The screenshot shows a dialog box titled "Test AAA Servers". It contains the following fields and controls:

- Name:** A dropdown menu with "RADIUS" selected.
- Protocol:** Radio buttons for "PAP" (selected) and "CHAP".
- User Name:** A text input field.
- Password:** A text input field with a "Show password" checkbox below it.
- Buttons:** "Test" and "Cancel" buttons at the bottom right.

Figure 138: The Test AAA Servers form

## Deleting an Administrator Account, Role, or RADIUS Server

Administrator accounts allow you to share or delegate management and monitoring functions within your team, and roles allow you to define tasks for each assignee within your team. You can also add RADIUS servers to authenticate and authorize administrators.

Follow these steps to delete an administrator account, role, or RADIUS server that is used for authenticating administrators.

1. Go to **Configuration > Administrators**.
2. Locate the administrator account, role, or the RADIUS server that you want to delete.
3. Under the **Actions** column, click the icon that is in the same row as the account, role, or RADIUS server name.

A confirmation message appears.

4. Click **Yes**.

The page refreshes, and then the administrator account, role, or RADIUS server that you deleted disappears from the Administrators page.

You have completed deleting an administrator account, role, or RADIUS server used for authenticating administrators.

**NOTE:** The default administrator account and role, which exist on the controller by default, cannot be deleted.

# Managing Mobile Virtual Network Operator Accounts **10**

In this chapter:

- [Overview of Mobile Virtual Network Operator Accounts](#)
- [Viewing a List of MVNOs](#)
- [Creating a New MVNO Account](#)
- [Using a Backup RADIUS Server for Authorizing and Authenticating MVNOs](#)
- [Editing an MVNO Account](#)
- [Deleting an MVNO Account](#)

## Overview of Mobile Virtual Network Operator Accounts

This section describes how to create, edit, and delete mobile virtual network operator accounts.

### Viewing a List of MVNOs

A Mobile Virtual Network Operator (MVNO) uses a host carrier network to service its mobile users. An MVNO account is created for each operator and the MVNO page lists the accounts that are created.

Follow these steps to view a list of mobile virtual network operator (MVNO) accounts.

- Go to **Configuration > Mobile Virtual Network Operators**.  
The MVNO table appears and displays a summary of mobile virtual network operator accounts that have been created.

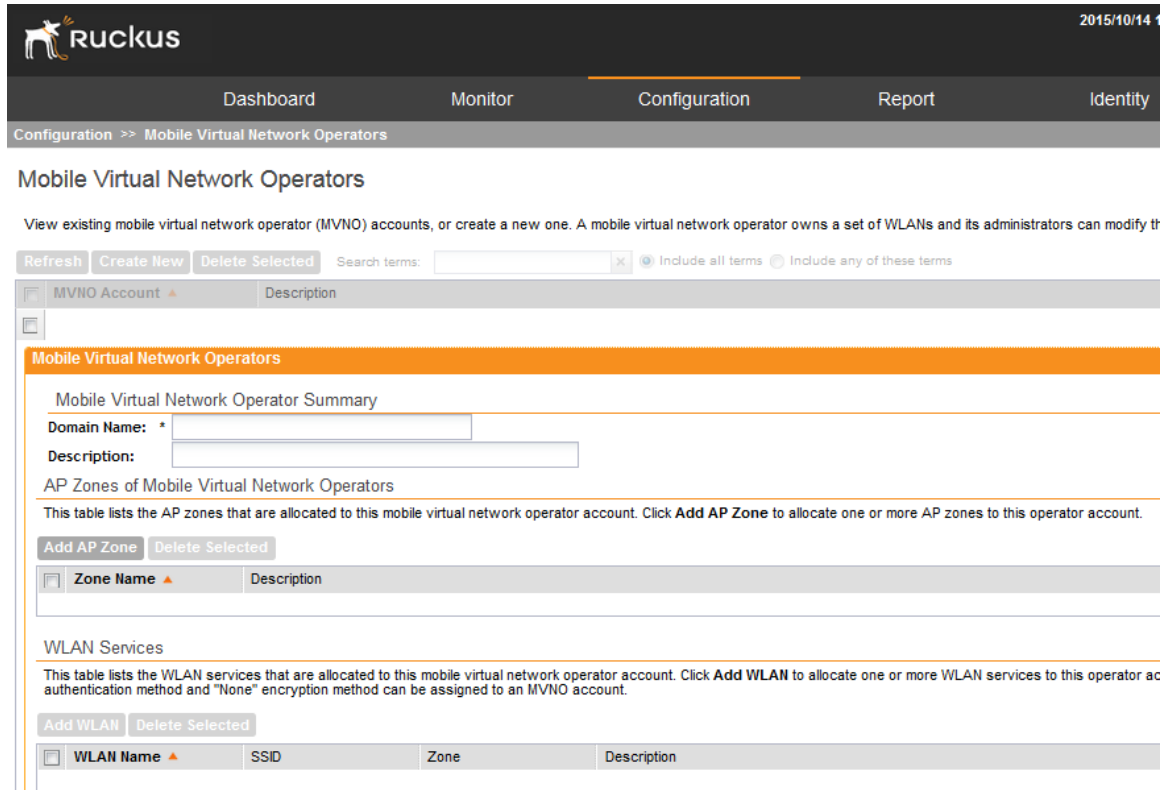


Figure 139: The Mobile Virtual Network Operators page

## Creating a New MVNO Account

Mobile Virtual Network Operator Accounts (MVNO) page allows you to create, edit, and delete mobile virtual network operator accounts.

Follow these steps to create a new virtual network operator account.

1. On the **MVNO** page, click **Create New**.

The **Mobile Virtual Network Operator** form appears.

2. In **Mobile Virtual Network Operator Summary** section:
  - a) Type a domain name to which this account will be assigned in the **Domain Name** box.
  - b) In **Description**, type a brief description about this domain name.
3. In Configure the AP zones to which the MVNO account that you are creating will have management privileges. Click **Add AP Zone** to create an AP Zone(s)
  - a) In **AP Zone**, select the AP zone to which the MVNO account will have management privileges.

**NOTE:** You can only select a single AP zone at a time. If you want to grant the MVNO account management privileges to multiple AP zones, select them one at time.

- b) Click **Apply**.


The **AP Zones of Mobile Virtual Network Operator** section refreshes. The AP zone or zones that you selected appears in the section.

4. In **Configure the WLAN** services, follow these steps to configure the WLAN services to which the MVNO account that you are creating will have management privileges.
  - a) In the **WLAN services** section, click **Add WLAN(s)**.
  - b) In **SSID**, select the WLAN to which the MVNO account will have management privileges.

**NOTE:** You can only select one WLAN service at a time. If you want to grant the MVNO account management privileges to multiple WLAN service zones, select them one at a time.

- c) Click **Apply**.  
The WLAN services section refreshes. The WLAN service or services that you selected appears in the section.
5. In **Create the Super Administrator Account**, follow these steps to create the MVNO account and define the logon details and management capabilities that will be assigned to the account.
  - a) Scroll down to the **Super Administrator** section.
  - b) In **Account Name**, type the name that this MVNO will use to log on to the controller.
  - c) In **Real Name**, type the actual name (for example, John Smith) of the MVNO.
  - d) In **Password**, type the password that this MVNO will use (in conjunction with the Account Name) to log on to the controller.
  - e) In **Confirm Password**, type the same password as above.
  - f) In **Phone**, type the phone number of this MVNO.
  - g) In **Email**, type the email address of this MVNO.
  - h) In **Job Title**, type the job title or position of this MVNO in his organization.
  - i) In the **Assign Capabilities to Administrator Role** tree (located on the right side of the form), select the administrator capabilities that you want to assign to this MVNO.

If you plan to grant this MVNO most of the capabilities that are available, click **Select All**, and then clear the check boxes for the capabilities that you do not want this MVNO to have.

- j) Remember to click the  icon next to each folder to view all capabilities that are included.
6. In **RADIUS Server for Administrator Authorization and Authentication**, follow these steps to add a RADIUS server for authenticating this MVNO.

**NOTE:** If you want to use a primary and secondary RADIUS servers for authenticating administrator, follow the steps in [Using a Backup RADIUS Server for Authorizing and Authenticating MVNOs](#) on page 265.

- a) In the **RADIUS Servers for Administrator Authorization and Authentication** section, click **Create New**.

The **RADIUS Servers for Administrator Authorization and Authentication** form appears.

- b) In **Name**, type a name for the RADIUS service.
  - c) In **Realm**, type the realm or realms to which the RADIUS server belongs.

If the RADIUS server belongs to multiple realms, use a comma (,) to separate the realm names.

- d) Make sure that the **Enable backup RADIUS support** check box is not selected.
- e) If you want to use a backup RADIUS server, follow the steps in Using a Backup RADIUS Server for Authenticating Administrators instead.
- f) In **IP Address**, type the IP address of the RADIUS server.
- g) In **Port**, type the UDP port that the server is using. The default port is 1812.
- h) In **Shared Secret**, type the shared secret.
- i) Retype the same secret in **Confirm Secret**.
- j) Click **Apply**.

After you complete steps 1 on page 262 through 6 on page 263, click **Create New** to save the MVNO account. The page refreshes, and the MVNO account that you created appears on the list of existing MVNO accounts.

**Mobile Virtual Network Operator Summary**

Domain Name:

Description:

**AP Zones of Mobile Virtual Network Operators**

This table lists the AP zones that are allocated to this mobile virtual network operator account. Click **Add AP Zone** to allocate one or more AP zones to this operator account.

Zone Name ▲	Description
-------------	-------------

**WLAN Services**

This table lists the WLAN services that are allocated to this mobile virtual network operator account. Click **Add WLAN** to allocate one or more WLAN services to this operator account. Please note that the "None" encryption method can be assigned to an MVNO account.

WLAN Name ▲	SSID	Zone	Description
-------------	------	------	-------------

**Super Administrator**

Create a super administrator account to manage the network resources that are allocated to the mobile virtual network operator account. The super administrator role defines the privileges of the super administrator.

Account Name:

Real Name:

Password:

Confirm Password:

Phone:

Email:

Job Title:

**Assign Capabilities to Administrator Role**

Type a keyword to find a capability

- Configuration
- WLAN
- Templates
- Services and Profiles
- Management Domains
- Administrators
- Monitor

Figure 140: The Create New Virtual Network Operator form



## Using a Backup RADIUS Server for Authorizing and Authenticating MVNOs

If a backup RADIUS server is available on the network, you can select the **Enable backup RADIUS server support** check box to use the backup server when the primary server is unavailable.

When you select the check box, additional fields appear that you need to fill in.

Follow these steps to enable support for a backup RADIUS server for authorizing and authenticating MVNOs.

1. Select the check box next to **Enable backup RADIUS support**.
2. In the **Primary Server** section, fill out the IP address, port number, and shared secret as you did in the previous section.
3. In the **Secondary Server** section, fill out the IP Address, port number and shared secret for the backup server (these fields can neither be left empty nor be the same values as those of the primary server).
4. Click **Apply**.

You have completed adding primary and secondary RADIUS servers for authorizing and authenticating MVNOs.

## Editing an MVNO Account

A Mobile Virtual Network Operator (MVNO) uses a host carrier network to service its mobile users. An MVNO account is created for each operator and the MVNO page allows you to edit the account.

1. Go to **Configuration > Mobile Virtual Network Operators**.

The **Mobile Virtual Network Operator** page appears, displaying all MVNO accounts that have been created.

2. Click the domain name of the MVNO account that you want to edit.
3. Edit or update the account details in the following sections as required:
  - **Mobile Virtual Network Operator Summary**
  - **AP Zones of Mobile Virtual Network Operator**
  - **WLAN services**
  - **Super Administrator** (and Assign Capabilities to Administrator Role)
  - **RADIUS Servers for Administrator Authorization and Authentication**
4. Click **Apply**.


You have completed editing the MVNO account.

## Deleting an MVNO Account

A Mobile Virtual Network Operator (MVNO) uses a host carrier network to service its mobile users. An MVNO account is created for each operator and the MVNO page allows you to delete obsolete accounts.

1. Go to **Configuration > Mobile Virtual Network Operators**.

The **Mobile Virtual Network Operator** page appears, displaying all MVNO accounts that have been created.

2. Locate the domain name of the MVNO account that you want to delete.
3. Once you locate the MVNO account, click the  icon that is under the **Actions** column. A confirmation message appears.
4. Click **Yes**.  
The list of MVNO accounts refreshes, and then the MVNO account that you deleted disappears from the list.

You have completed deleting an MVNO account.

# Creating and Managing Hotspots

In this chapter:

- [Overview of Hotspot Management](#)
- [Hotspot Terminologies](#)
- [How Hotspot Authentication Works](#)
- [Call Flow for Devices That Use a Web Proxy](#)
- [User Agent Blacklist](#)
- [Notes on Using iOS Devices to Access the Hotspot](#)
- [Notes on Using Amazon Kindle Fire to Access the Hotspot](#)
- [What You Will Need](#)
- [Hotspot Configuration Options](#)
- [Downloading Captive Portal and Subscriber Portal Logs](#)

## Overview of Hotspot Management

A hotspot is a venue or area that provides Internet access to devices with wireless networking capability, such as notebooks and smart phones. Hotspots are commonly available in public venues such as hotels, airports, coffee shops, and shopping malls.

All Ruckus Wireless access points have a built-in hotspot module that can be enabled and deployed on available WLANs. In addition to the hotspot capability of Ruckus Wireless access points, the controller provides the Captive Portal and Subscriber Portal modules, which are required by a hotspot infrastructure.

This chapter provides information on how to enable and configure the hotspot portal that the controller-managed access points provide.

**NOTE:** Ruckus Wireless hotspot portals are based on the Wireless Internet Service Provider roaming (WISPr) standards.

## Hotspot Terminologies

The hotspot terms that are used in this guide. Before continuing, Ruckus Wireless® recommends that you become familiar with these terms.

<b>Hotspot client</b>	A wireless client or device that is associating with a hotspot portal
<b>Hotspot user</b>	A human user using the hotspot portal on the hotspot client
<b>Captive Portal</b>	A controller module that intercepts a hotspot user's initial connection attempt to the Internet and redirects the connection to the Subscriber Portal (either internal or external). The Captive Portal and the Subscriber Portal make up the hotspot module of the controller.

<b>Subscriber Portal</b>	A controller module that allows a hotspot user to enter his or her hotspot user name and password to gain access to the hotspot portal (either through browser-based logon or Smart Client logon).
<b>Authenticated user</b>	A user who has passed the authentication process
<b>Unauthenticated user</b>	A user who has not passed the authentication process or has failed authentication
<b>Walled garden</b>	The purpose of the walled garden is to let unauthenticated users access online registration, payment services, or other websites (such as a hotel reservation page) without needing to log on first. All other sites are off-limits.

## How Hotspot Authentication Works

This section describes the steps that a hotspot user performs to gain access to the hotspot portal and how the controller handles the hotspot access request.

**NOTE:** Ruckus Wireless hotspot portals are based on the Wireless Internet Service Provider roaming (WISPr) standards.

1. A hotspot client associates with the hotspot WLAN service (which is typically unencrypted) that is provided by a Ruckus Wireless AP.

**NOTE:** The hotspot modules – Captive Portal and Subscriber Portal – communicate with the AP through the user defined interface (if configured) or the control Interface. For information on creating a user defined interface, refer to [Creating a User Defined Interface](#) on page 277.

2. The hotspot user attempts to browse the Web (for example, [www.ruckuswireless.com](http://www.ruckuswireless.com)) on the hotspot client.
3. The AP detects the user state (which, in this case, is unauthenticated) and performs network address translation (NAT) to the related port on the Captive Portal. The AP also adds information to the HTTP header, including the AP SSID and device MAC address and IP address.
4. The Captive Portal module first applies the blacklist user-agent (see [User Agent Blacklist](#) on page 274), and then the walled garden list to the request (URL whitelist, only for UEs configured with web proxy. The AP handles the walled garden for non-web proxy UEs). If the request passes these two filters, the Captive Portal redirects the hotspot user to the configured portal URL. In case it was configured as an internal portal, the Subscriber Portal module handles the request and displays the hotspot logon page.

**NOTE:** The controller provides a built-in Subscriber Portal module that you can use immediately.

5. The hotspot user enters the user name and password provided by the hotspot operator on the logon page that is presented by the Subscriber Portal.

6. The portal sends a JSON HTTP request to the controller's northbound interface, which identifies (based on some parameters) the configured AAA server for this request. It then sends the authentication request to the AAA server.
7. The AAA server responds with an Access Accept or Access Reject message.
8. If the user was authenticated successfully, the controller's northbound interface sends a command to the AP to change its state to `Authorized`, so any further traffic from this UE will be permitted. The northbound interface also sends a `successful` response to the portal.

If the portal is an internal portal, a `successful` message appears to the user and the user must click the Continue button on the browser page to go to the original URL that he or she intended to visit. Once logged on to the hotspot, all traffic from the UE is routed directly through the AP to the Internet, unless tunnel mode is enabled on the WLAN or the user is using a web proxy.

Alternatively, instead of redirecting the UE after a successful authentication to the original URL that he or she intended to visit, the portal can be configured to redirect the user to a different page (for example, if the hotspot is in a shopping mall, the user can be redirected to the shopping mall home page after he or she clicks the Continue button).

The user has completed the hotspot authentication process and is now able to connect to the Internet.

**NOTE:** For users to be able to access the subscriber portal, it must be resolved to the UEs directly as well as to the controller itself. This is because UEs that use proxy settings are unable to resolve the subscriber-portal URL directly (but are able to resolve the captive portal). One of the following alternatives needs to be performed: (1) The DNS server with which users are associated must resolve the subscriber portal URL. Likewise, the DNS server with which the controller is associated must resolve the subscriber portal URL. (2) The UEs and the controller must be associated with the same DNS server and the DNS server must resolve the subscriber portal URL.

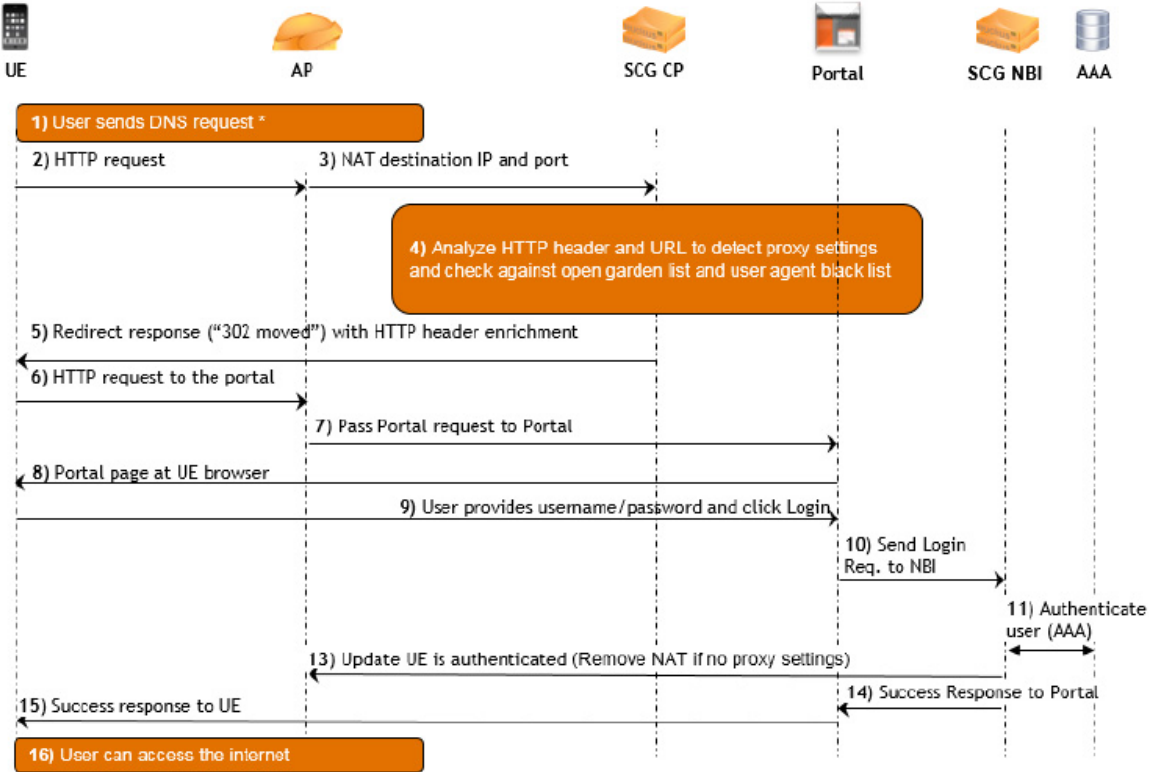


Figure 141: Basic flow of the hotspot authentication process for an HTTP-based request

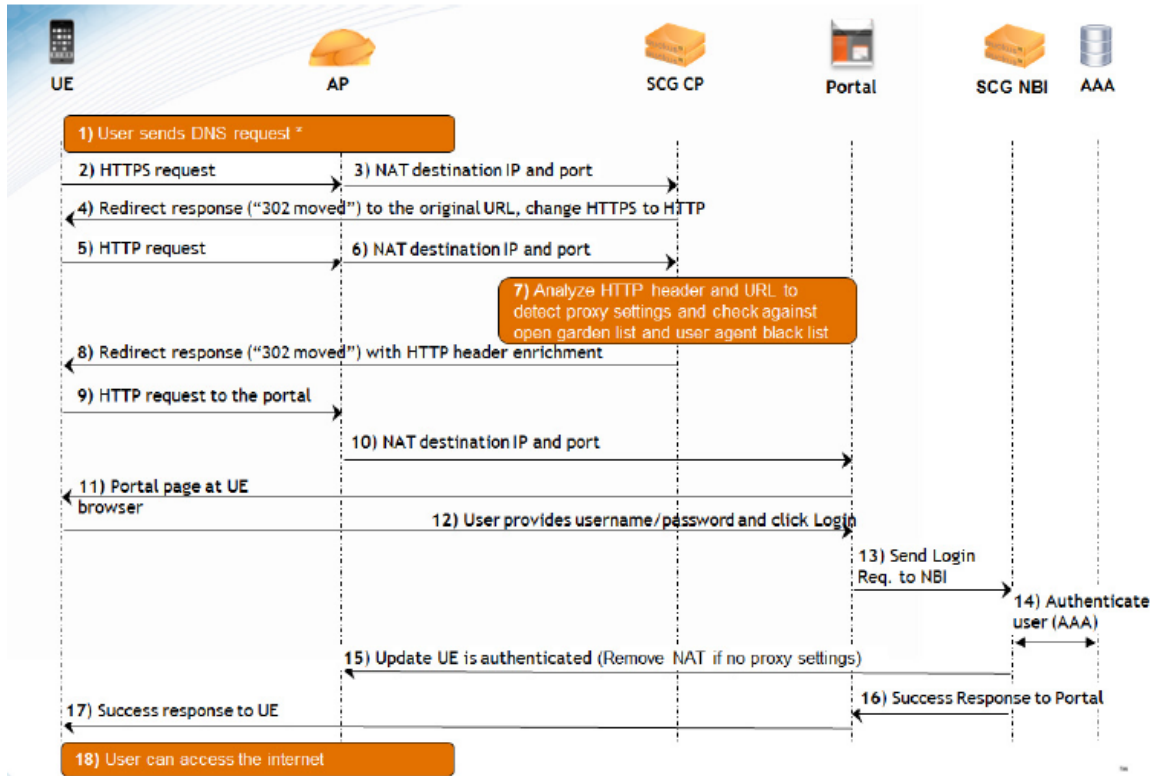


Figure 142: Basic flow of the hotspot authentication process for an HTTPS-based request (double-redirect approach)

## Call Flow for Devices That Use a Web Proxy

If a user device is configured to use a Web proxy server to gain access to the Internet, the call flow for the hotspot authentication process is different.

This is because the AP needs to perform network address translation (NAT) on the HTTP or HTTPS request from the user device and the Captive Portal functions as a proxy between the user device and Web server on which the requested URL is hosted.

Figure 143: Basic flow of the hotspot authentication process for an HTTP proxy-based request on page 272 illustrates that call flow for the hotspot authentication process if the user device is using a Web proxy server to connect to the Internet.

There are two types of proxies - Transparent and Non-Transparent.

Transparent proxy is an in-line proxy in which the user device or its browser need not be configured, as requests are *transparently* intercepted by the proxy.

Non-Transparent proxy is an out-of-line proxy where the user device or browser (depending on the device OS) must be configured with the proxy settings for the proxy to receive requests.

The call flow described in this section relates to Non-Transparent proxy deployments.

**NOTE:** Every request from the user device goes through the Captive Portal, even after the user device is authenticated.

**NOTE:** Hotspot redirection will fail if the proxy is on the same subnet as the client, or if the client proxy configuration is any port other than 8080 or 3128.

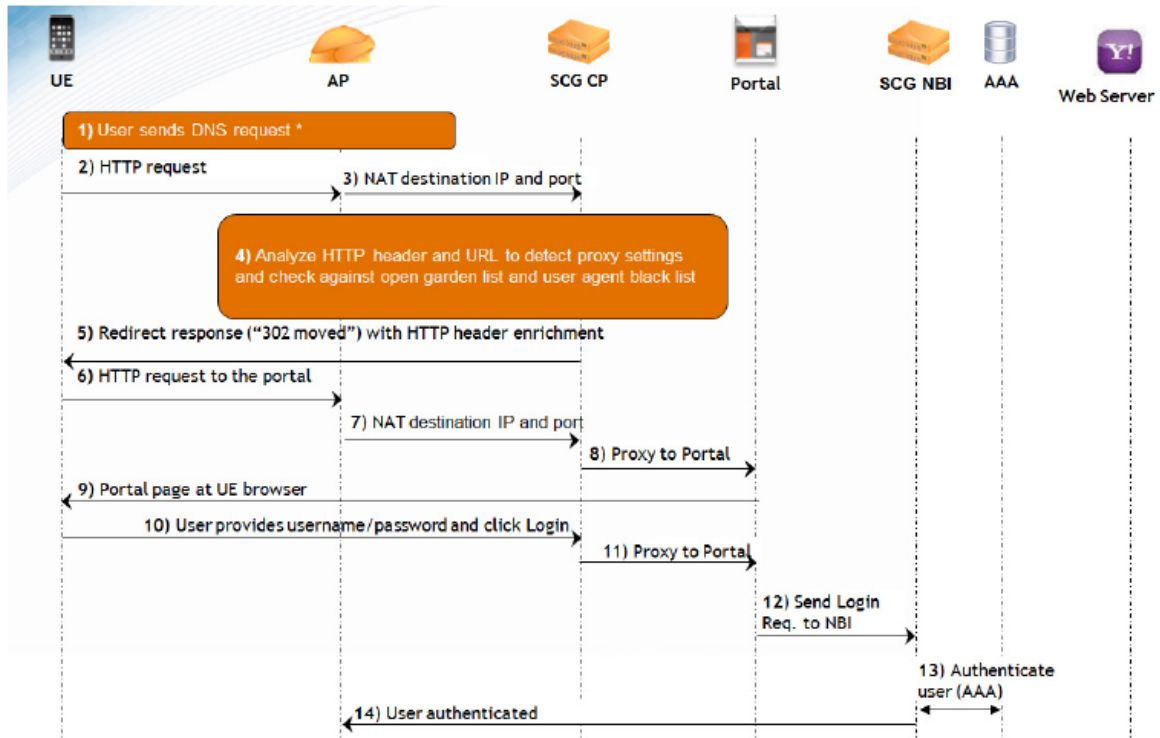


Figure 143: Basic flow of the hotspot authentication process for an HTTP proxy-based request



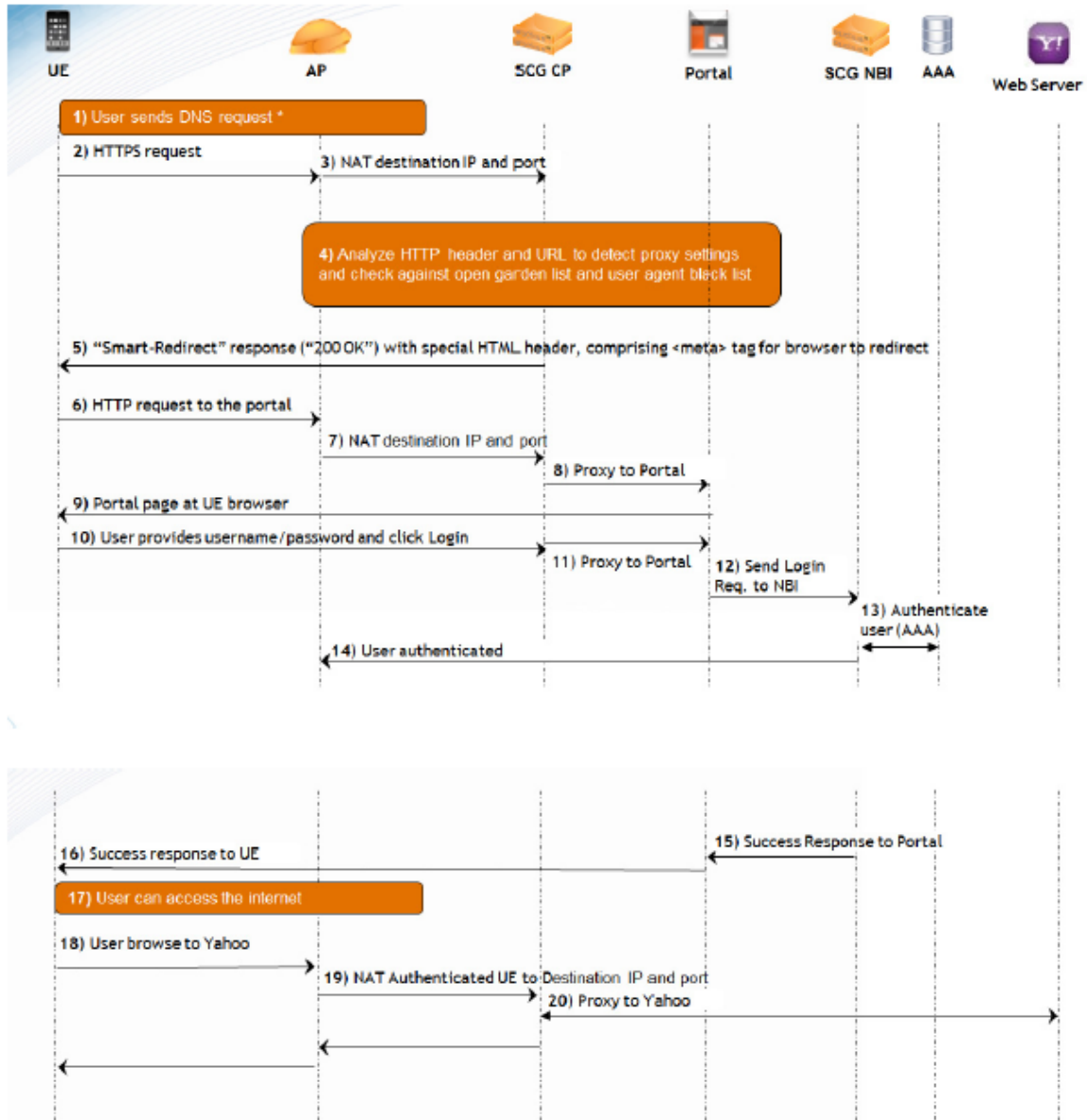


Figure 144: Basic flow of the hotspot authentication process for an HTTPS proxy-based request

### Devices Using a Static Web Proxy

If a client device is configured to use a static Web proxy, the client Web browser will use predefined proxy settings, which will prevent it from being redirected to the Captive Portal successfully.

The controller's built-in Web proxy application can establish a connection with the browser, assume the role of a proxy, and then redirect the user to the logon page for authentication and, after a successful authentication, to the requested page.

## Devices Using a Dynamic Web Proxy

If a client device is configured to use a dynamic Web proxy, it typically receives its proxy settings in a proxy auto-config (PAC) file from a server on the local network. If you have such client devices on the network, you can use the Captive Portal to respond to the request for a PAC file from these devices with a preconfigured PAC file.

This preconfigured PAC file disables the proxy settings on client devices and enables them to connect to the network without going through a proxy server. The preconfigured PAC file is located in the configuration directory of the Captive Portal.

The controller supports both proxy auto-config (PAC) and Web Proxy Autodiscovery Protocol (WPAD). Currently, the controller uses a PAC file that supports requests for both PAC and WPAD proxy configuration files.

## User Agent Blacklist

By default, the controller automatically blocks certain user agents (or software used by a user) from accessing the hotspot.

These blocked user agents include:

- ZoneAlarm
- VCSoapClient
- XTier NetIdentity
- DivX Player
- Symantec LiveUpdate
- Windows Live Messenger
- StubInstaller
- windows-update-agent
- Windows Live Essentials
- Microsoft Dr. Watson for Windows (MSDW)
- Avast Antivirus Syncer
- Microsoft Background Intelligent Transfer Service (BITS)
- Google Update
- TrendMicro client
- Skype WISPr

When the controller blocks any of these user agents, an error message appears on the user device.

You can add or remove user agents from this blacklist. For more information, see [Managing the Global User Agent Black List](#) on page 210.

**NOTE:** In release 3.0, Microsoft NCSI was included in the user agent blacklist. This prevented Windows Network Awareness, a feature that allows Windows services and applications to automatically select the network connection best suited to their tasks, from working properly. Microsoft NCSI has been removed from the user agent blacklist in release 3.1 and later.

## Notes on Using iOS Devices to Access the Hotspot

When an iOS device (for example, Apple iPhone or iPad) associates with a hotspot, it probes for an Internet connection by sending an HTTP request to the following Web page:

```
http://www.apple.com/library/test/success.html
```

**NOTE:** Devices running on newer iOS versions issue a request with a special User-Agent, which contains the "CaptiveNetworkSupport" string in the User-Agent header.

If the iOS device does not receive an appropriate response from www.apple.com, the hotspot logon page does not appear on the device. If the iOS device user closes or skips the hotspot logon page, the device is disconnected from the network and is unable to browse even the network destinations (IP addresses or Web addresses) defined in the walled garden.

Since the walled garden is not URI-capable and adding www.apple.com to the walled garden can cause significant data consumption on the controller server, Ruckus Wireless has designed the Captive Portal to respond to the HTTP request sent by the iOS device with the following page:

```
<!DOCTYPE HTML PUBLIC "-//W3C//DTD HTML 3.2//EN">
<HTML>
<HEAD>
  <TITLE>Success</TITLE>
</HEAD>
<BODY>
  Success
</BODY>
</HTML>
```

## Notes on Using Amazon Kindle Fire to Access the Hotspot

The behavior of Amazon Kindle Fire devices is similar to the behavior of devices running older iOS versions, except HTTP requests from Kindle devices use a different URL:

```
http://spectrum.s3.amazonaws.com/kindle-wifi/wifistub.html
```

Ruckus Wireless has designed the Captive Portal to respond to the HTTP request sent by the Kindle Fire device with the following page:

```
<!DOCTYPE html PUBLIC "-//W3C//DTD HTML 4.01//EN"
"http://www.w3.org/TR/html4/strict.dtd">
<html>
<head>
<title>Kindle Reachability Probe Page</title>
<META http-equiv="Content-Type" content="text/html;
charset=iso-8859-1">
<!--81ce4465-7167-4dcb-835b-dcc9e44c112a created with python 2.5
uuid.uuid4() -->
```

```
</head>
<body bgcolor="#ffffff" text="#000000">
81ce4465-7167-4dcb-835b-dcc9e44c112a
</body>
</html>
```

## What You Will Need

To enable controller-managed access points to provide hotspot portals, you will need the following:

1. RADIUS server for authenticating hotspot users
2. RADIUS accounting server (optional) for monitoring usage of hotspot users.

## Hotspot Configuration Options

You can create a hotspot portal when you configure one of the following:

- A WLAN service of an AP zone
- A zone template
- A WLAN template

The steps described in this section must be completed when you configure a WLAN service of an AP zone or when you create a zone template or WLAN template.

This section provides additional information on the hotspot configuration options that are available from within the forms for creating a zone template or WLAN template.

### Why Create a User Defined Interface

APs use the control interface to communicate receive configuration updates from the controller. If you want to have a logical separation of the UE traffic and the AP control traffic, you can create a user defined interface (UDI).

If a UDI is configured (using the control interface as its physical interface and providing a hotspot portal as shown below), APs use it to perform Destination Network Address Translation (DNAT) of requests from unauthorized UEs to the controller's captive portal (otherwise, APs use the control interface)

<input type="checkbox"/>	Name	Physical Interface	Service
<input type="checkbox"/>	UDI	Control Interface	Hotspot

**Figure 145: A UDI configured to use the control interface as its physical interface and to provide a hotspot portal**

The controller's captive portal redirects the UE to the configured portal logon page URL. When the UE triggers this portal URL request, the AP lets the request through (without performing DNAT to the controller's captive portal), as it is configured as an ACL on AP, directly to the external portal server.

## Creating a User Defined Interface

The hotspot modules – Captive Portal and Subscriber Portal – require a user defined interface to communicate with the hotspot AP. The controller uses this user defined interface (which you will need to create) to receive hotspot logon data from hotspot users.

This section describes how to create a user defined interface that you can use for the hotspot portal and how to enable the northbound portal interface.

Follow these steps to create a user defined interface.

1. Go to **Configuration > System > Cluster Planes**.
2. In the **Control Plane** section, click the control plane on which you want to create the user defined interface for the hotspot portal.

The **Edit Control Plane Network Settings** form appears.

3. Click the **User Defined Interface** tab.
4. Click **Create New**.  
Empty boxes on the **User Defined Interface** tab appear.
5. Configure the following interface settings:
  - **Name**: Assign a name to this user defined interface.
  - **IP Address**
  - **Subnet Mask**
  - **Gateway**
  - **VLAN**: Assign a VLAN ID to the user defined interface.
  - **Physical Interface**: Select Control Interface.
  - **Service**: Select Hotspot.

6. Click **Apply**.

A confirmation message appears.

7. Click **Yes**.

The controller restarts automatically and applies the changes you made to the user defined interface. When the controller completes applying the changes, the following message appears:  
`Control plane configuration updated successfully.`

8. Click **Close** at the bottom of the form to close it.
9. Go to **Configuration > System > General System Settings**.

**NOTE:** If you are using the internal Subscriber Portal, skip Step 10 and Step 11. The controller automatically generates a 32-character random password for the northbound portal interface. If you are using an external Subscriber Portal, set the northbound portal interface password on the General System Settings page, and then enter the password in Step 10.

10. In the **Northbound Portal Interface** section, type the password for the northbound interface in the box provided.
11. Click **Apply**.

You have completed creating a user defined interface for the hotspot.

Cluster Planes

System IP Mode  
The system is capable of operating in either 'IPv4-only' or 'dual-stack (IPv4 plus IPv6)' mode. Please select your mode and verify appropriate network connectivity.

IP Support Version:  IPv4 only  IPv4 and IPv6

Refresh Apply Cancel

Refresh Rebalance APs

Control Planes

View existing control planes in the cluster. To view details about a control plane or to update its configuration, click the control plane name.

Name	Management IP	Cluster IP	Control IP	Model	Serial Number	# of APs	Description	Firmware	Cluster Role	Uptime
SCG34-IP-36-151-C	172.17.36.15...	7.7.7.1	1.1.1.24 / 200...	SCG200	22222222	0	SCG34-IP-36-151-test	3.4.0.0.26	Leader	1d 7h 30m

Edit Control Plane Network Settings [SCG34-IP-36-151-C]

This page lists the network configuration settings of the selected control plane. You can modify the interface settings, northbound control interface settings, or manually configure the static routes.

Physical Interfaces **User Defined Interfaces** Static Routes

This page lists the northbound control interfaces and virtual network interfaces (VNI). At most 16 VNIs and 1 hotspot are allowed to be configured.

Create New Delete Selected

<input type="checkbox"/>	Name	Physical Interface	Service	IP Address	Subnet Mask	Gateway	VLAN	Actions
<input type="checkbox"/>	UDI	Control Interface	Hotspot	1.1.1.1	255.255.255.240	101.255.14.2	1	

Figure 146: Creating a user defined interface

### Adding a RADIUS Server to the Controller

A hotspot requires a RADIUS server to authenticate users that are attempting to access the hotspot portal.

Use the form shown below to add a RADIUS server.

Create New RADIUS Service

General Options

Name: \*

Description:

Type:  RADIUS  RADIUS Accounting

Backup RADIUS:  Enable backup RADIUS support

Health Check Policy

Primary Server

IP Address: \*

Port: \* 1812

Shared Secret: \*

Confirm Secret: \*

Create New Cancel

Figure 147: The Create New RADIUS Service form

### Adding a RADIUS Accounting Server

If you want to monitor the usage of hotspot users (for example, for billing purposes), you can also add a RADIUS accounting to the controller.

The form for adding a RADIUS accounting server is the same as for adding a RADIUS server – you only need to click RADIUS Accounting instead of RADIUS.

## Creating a Hotspot WLAN

You can create a hotspot portal when you configure a WLAN service of an AP zone.

Follow the steps for [creating a WLAN](#). When you reach the **WLAN Usage Type** section, click **Hotspot (WISPr)**, and then complete the rest of the steps for creating a WLAN.

### Configuring Smart Client Support

Ruckus Wireless hotspots support the WISPr Smart Client feature, which allows client devices to log on to a hotspot seamlessly without requiring the user to go through the logon page.

The controller provides the following options for supporting Smart Clients:

- **None:** Click this option to prevent Smart Client applications from logging on to WLANs that include this hotspot configuration.
- **Enable:** Click this option to allow Smart Client applications to log on to WLANs that include this hotspot configuration.
- **Only Smart Client Allowed:** Click this option to allow only Smart Client applications to log on to WLANs that include this hotspot configuration. All other applications or browsers that attempt to access the hotspot will be shown a custom message, which you can enter in the box provided.

**NOTE:** Clicking **Only Smart Client Allowed** requires the use of the internal Subscriber Portal. The **Logon URL** and **Start Page** options are unavailable when the **Only Smart Client Allowed** option is selected

Figure 148: Smart Client support options

### Configuring the Hotspot Logon URL

Logon URL refers to the location of the Subscriber Portal module that serves the logon form for authenticating hotspot users.

There are two options available for the logon URL: Internal and External.

- **Internal:** Click this option if you want to use the Subscriber Portal module that is built into the controller.

- **External:** Click this option if you want to use the Subscriber Portal module that is installed on an external server. In the text box below, type the URL to the Subscriber Portal on the external server. In the example below, the Subscriber Portal module is installed on a server with the IP address 172.21.11.248, hence the logon URL is:  
`http://172.21.11.248:9997/SubscriberPortal/login`

**Figure 149: In Logon URL, click either Internal or External**

## Creating a WLAN

Now that you have created a hotspot portal, you are ready to create a hotspot WLAN.

1. In the **WLAN Usage** section, click **Hotspot (WISPr)**.
2. In **Hotspot Portal**, select the hotspot portal that you created in [Creating a Hotspot WLAN](#) on page 279.
3. Configure other settings are described in [Working with WLANs and WLAN Groups](#).
4. Save the template.

**NOTE:** Hotspot creation requires that you select a hotspot portal to use. Make sure that you already created a hotspot portal before you create a hotspot WLAN.



**Create New WLAN Configuration**

General Options

WLAN Usage

Access Network:  Tunnel WLAN traffic through Ruckus GRE

Authentication Type: \*  Standard usage (For most regular wireless networks)  
 Hotspot (WISPr)  
 Guest Access + Hotspot 2.0 Onboarding  
 Web Authentication  
 Hotspot 2.0 Access  
 Hotspot 2.0 Secure Onboarding (OSEN)  
 WeChat

Authentication Options

Encryption Options

Hotspot Portal

Hotspot (WISPr) Portal: \*

Bypass CNA:  Enable

Authentication Service: \*  Use the controller as proxy

Accounting Service:  Use the controller as proxy

Options

RADIUS Options

Advanced Options

Figure 150: Select the hotspot portal that you created earlier

You have completed configuring the hotspot settings in the zone template or WLAN template.

## Downloading Captive Portal and Subscriber Portal Logs

Follow these steps to download the Captive Portal and Subscriber Portal logs from the controller.

1. Go to **Administration > Diagnostics**.  
The **Diagnostics** page appears.
2. On the sidebar, click **Application Logs & Status**.  
The **Application Logs & Status** page appears.

- In **Select Control Plane**, select the control plane to which the Captive Portal module is connected.
- In the table below, locate the application named **CaptivePortal**.

You can view the following information about **CaptivePortal**, as well as the other applications in the controller:


- **Health Status**
- **Log Level**
- **# of Logs**

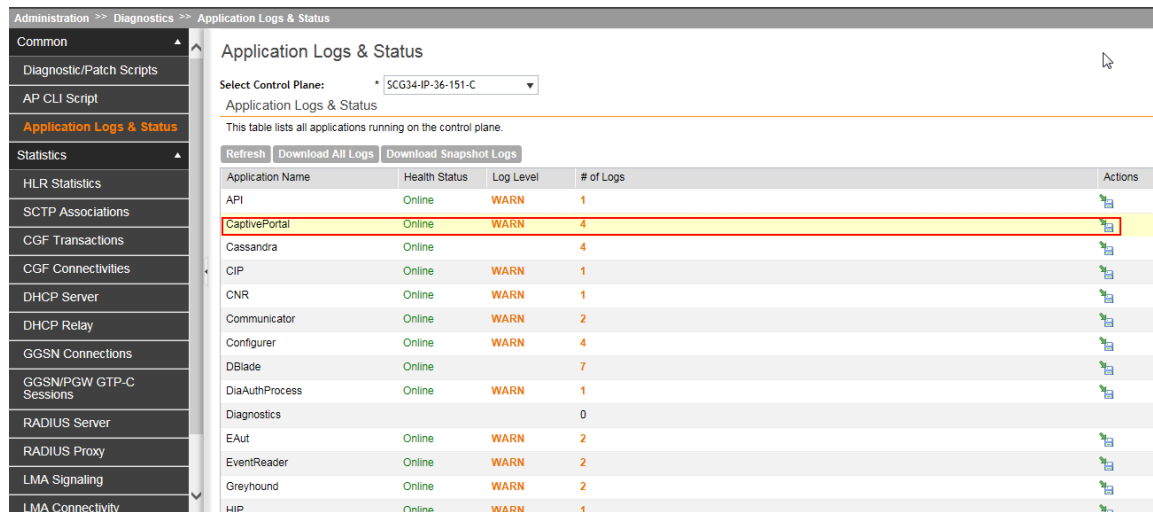
- Under the **Actions** column, click the  icon that is in the same row as **CaptivePortal**.

Your web browser downloads the logs in GZIP Compressed Tar Archive (with **.TGZ** extension) to its default download location.

- Go to your web browser's default download location and verify that the TGZ file was downloaded successfully.
- Use your preferred compression/decompression program to extract the log files from the TGZ file.

You have completed downloading the Captive Portal logs from the controller.

If you are using the built-in Subscriber Portal, scroll down the table to locate the SubscriberPortal application, and then click the  icon that is in the same row as SubscriberPortal to download its logs.



Administration >> Diagnostics >> Application Logs & Status

Application Logs & Status

Select Control Plane: SCG34-IP-36-151-C

Application Logs & Status

This table lists all applications running on the control plane.

Refresh Download All Logs Download Snapshot Logs

Application Name	Health Status	Log Level	# of Logs	Actions
API	Online	WARN	1	
<b>CaptivePortal</b>	Online	WARN	4	
Cassandra	Online		4	
CiP	Online	WARN	1	
CNR	Online	WARN	1	
Communicator	Online	WARN	2	
Configurer	Online	WARN	4	
DBlade	Online		7	
DiaAuthProcess	Online	WARN	1	
Diagnostics			0	
EAut	Online	WARN	2	
EventReader	Online	WARN	2	
Greyhound	Online	WARN	2	
HIP	Online	WARN	1	

Figure 151: Click the save to disk icon to download the Captive Portal logs

# Monitoring AP Zones, Access Points, and Wireless Clients 12

In this chapter:

- [Monitoring AP Zones](#)
- [Monitoring Managed Access Points](#)
- [Monitoring Wireless Clients](#)

In this chapter:

## Monitoring AP Zones

This section provides information on how to monitor and view information about AP zones. Topics covered include:

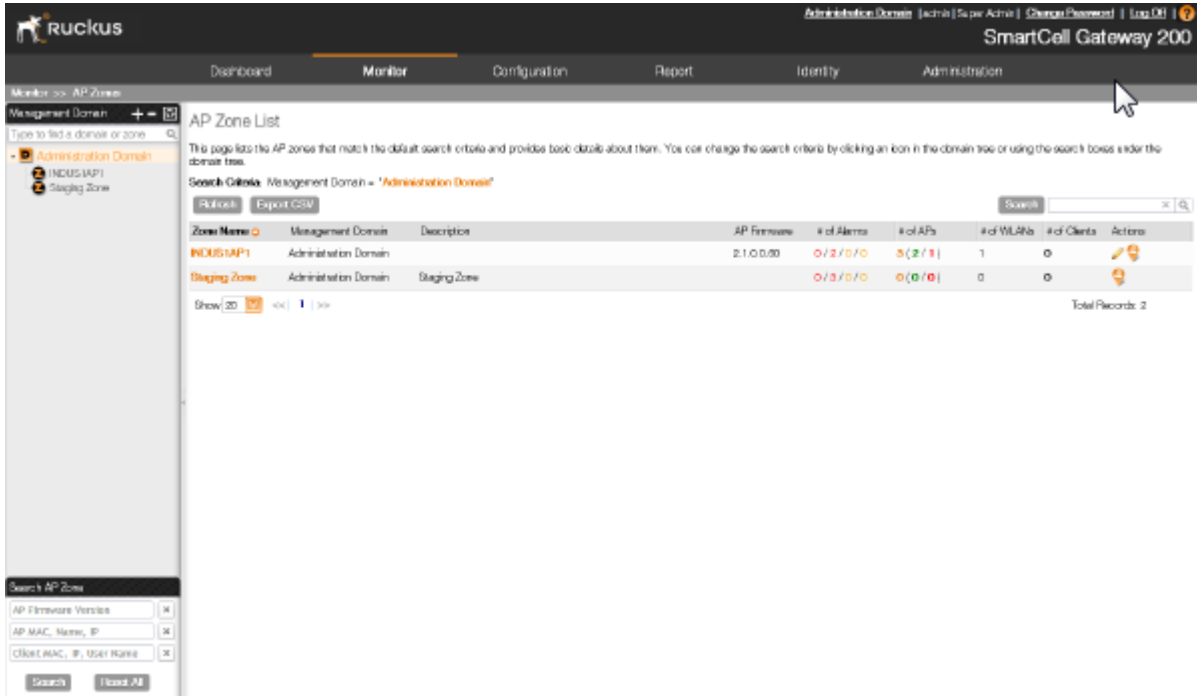
### Viewing a Summary of AP Zones

Summary helps you to view and monitor information about AP zones.

Follow these steps to view a summary of existing AP zones.


1. Go to **Monitor > AP Zones**.

The **AP Zones in Management Domain** page appears and displays a table of all existing AP zones.



**Figure 152: Select Administration Domain in the domain tree to view all existing AP zones**




When you go to the **Monitor > AP Zones** page, the **Administration Domain** is selected by default in the domain tree, which results in all existing AP zones being displayed in the table.

2. If you want to view only AP zones that belong to a particular subdomain (denoted by the  icon in the domain tree), click the **subdomain** icon. The table refreshes and displays only AP Zones that belong to that subdomain.

[Table 14: AP zone details](#) on page 284 lists the AP zone details that are shown in the table.

**Table 14: AP zone details**

Column Name	Description
<b>Zone Name</b>	Name of the AP zone. Clicking the AP zone name (link) loads a page that displays detailed information about the zone. See <a href="#">Viewing the Configuration of an AP Zone</a> on page 286.
<b>Management Domain</b>	Administration Domain or subdomain name to which the AP zone belongs. Clicking this link displays detailed information about the Administration domain or subdomain.
<b>Description</b>	Brief description of the AP zone
<b>AP Firmware</b>	Ruckus Wireless firmware version that is installed on the APs that belong to the zone

Column Name	Description
<b># of Alarms</b>	<p>Number of alarms that have occurred in the AP zone. The numbers that are separated by a forward slash indicate the number of alarms per alarm type (from left to right order):</p> <p>Critical alarms (red)</p> <p>Major alarms (red)</p> <p>Minor alarms (orange)</p> <p>Warnings (orange)</p>
<b># of APs</b>	<p>Number of APs that belong to this zone. The numbers that are separated by a forward slash indicate the total number of APs in the zone (orange), the number of APs that are currently online (green), and the number of APs that are currently offline (red).</p> <p>Clicking the number of APs (link, except when zero) loads a page that displays detailed information about the APs. See <a href="#">Viewing a Summary of Access Points</a> on page 287.</p>
<b># of WLANs</b>	Number of WLAN services that exist in this zone
<b># of Clients</b>	<p>Number of wireless clients that are currently associated with APs in this zone. Clicking the number of clients (link, except when zero) loads a page that displays detailed information about the wireless clients. See <a href="#">Viewing a Summary of Wireless Clients</a> on page 294.</p>
<b>Actions</b>	<p>Icons for actions that you can perform, including:</p> <p> – Click to view detailed configuration of this AP zone.</p> <p> – Click to view all access points that belong to this AP zone on Google Maps. See <a href="#">Viewing All APs That Belong to an AP Zone on Google Maps</a> on page 287.</p> <p> – Click to view the mesh topology of this AP zone.</p>

## Exporting the AP Zone List to CSV

Follow these steps to export the AP zone list to a CSV file.

**1. Go to Monitor > AP Zones.**

The **AP Zone List** page appears.

**2. Click the Export CSV button in the content area.**

The following message appears: `Downloading AP Zone Data. Please wait...`

- When the message disappears, check the default download folder for your web browser and look for a file named `zone.csv`.
- Use a spreadsheet application (for example, Microsoft Excel®) to view the contents of the CSV file.

You have completed exporting the AP zone list to CSV.

#### AP Zone List

This page lists the AP zones that match the default search criteria and provides basic information about them. You can use below **Load Criteria** or search box to search specific zones.

Refresh **Export CSV** Search terms:   Include all terms  Include any of these terms

▼ Load Criteria: Domain = "Administration Domain"


Zone Name ▲	Management Domain	Description	AP Firmware	# of Alarms	# of APs	# of WL
Staging Zone	Administration Domain	Staging Zone		0 / 1 / 0 / 0	1 ( 0 / 1 / 0 / 0 / 0	0
zone1	Administration Domain		3.2.0.0.548	0 / 1 / 0 / 0	1 ( 1 / 0 / 0 / 0 / 2	

Show  << | 1 | >>

Figure 153: Click the Export CSV button

### Viewing the Configuration of an AP Zone

Follow these steps to view the configuration of an AP zone.

- On the **AP Zone List** page, locate the AP zone whose details you want to view.
- Under the **Actions** column, click the  icon that is in the same row as the AP zone name.

The page refreshes and displays the AP zone configuration details (shown in [Figure 154: Page showing the AP zone configuration details](#) on page 286).


The screenshot shows the Ruckus SmartCell Gateway 200 configuration interface. The main content area is titled "AP Zone: scg182\_test1 >> Zone Configuration". It contains several sections:

- General Information:** Zone Name (scg182\_test1), Description, Created By (admin), Updated On (2013/07/08 23:49:43), AP Firmware (2.1.0.0.50), Mesh (Disabled), Country Code (United States), and Switchover Cluster (Disable).
- Radio & Tunnel Information:** Background Scanning (2-4G-40MHz, 20 Seconds / 20 Seconds), Channelization (2.4G/20), Channel (2.4G/5G), TX Power Adjustment (2.4G/5G) (Auto / Auto/Indoor / Auto/Outdoor), Tunnel Type (GRE+UDP), Tunnel Encryption (Unencrypted), and Tunnel MTU Option (Auto).
- AP Model Specific Configuration:**
  - General Options:** Station LEDs (Disable status LEDs), LLDP (Enable Link Layer Discovery Protocol), LLDP Advertisement Interval (1-300 seconds) (30), LLDP Hold Time (30-1800 seconds) (120), and LLDP Management IP TLV (Enable).
  - Port Settings:** Three LAN ports (LAN1, LAN2, LAN3) are listed, each with an Enable Type (Trunk Port), VLAN Untag ID (1), and Members (1-4894, 802.1X) (Disabled).

Figure 154: Page showing the AP zone configuration details

## Viewing All APs That Belong to an AP Zone on Google Maps

Follow these steps to view all APs that belong to a particular AP zone on Google Maps.

1. On the **AP Zone List** page, locate the AP zone that you want to view.
2. Under the **Actions** column, click the  icon that is in the same row as the AP zone name. The page refreshes and displays the locations of all APs that belong to the zone on Google Maps™.
3. To view a summary of details about an AP on the map, click the icon for the AP. A text bubble appears and displays the AP details.

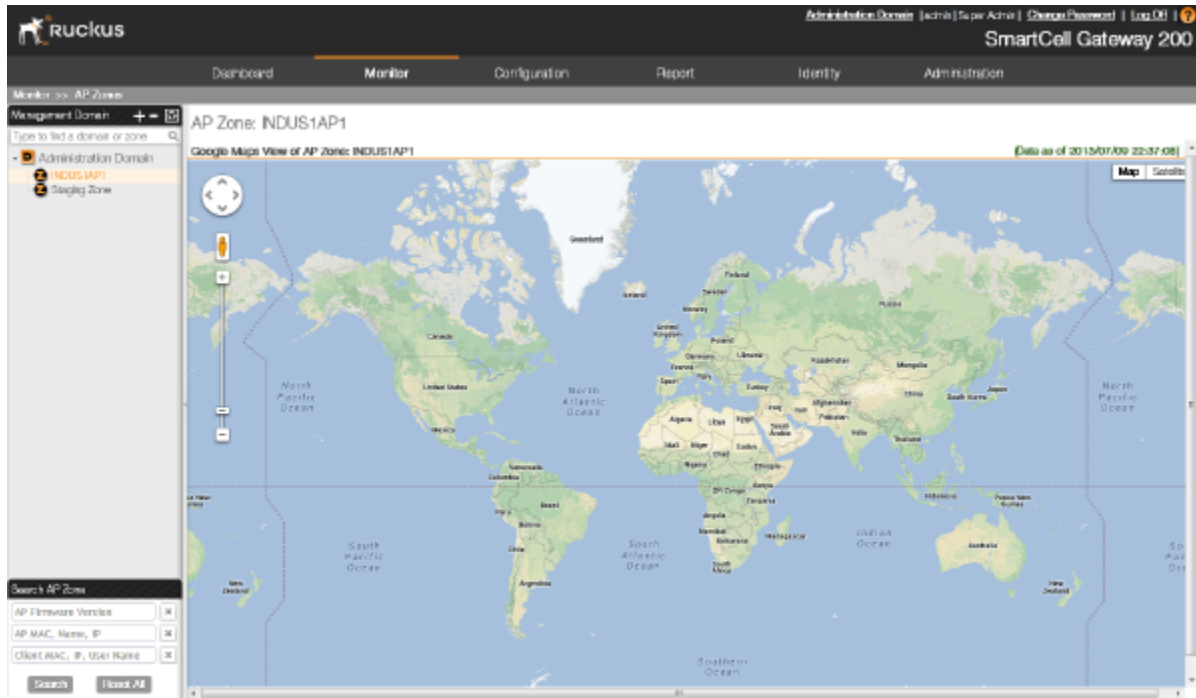


Figure 155: Page showing APs that belong to the AP zone on Google Maps

## Monitoring Managed Access Points

This section provides information on how to monitor and view information about the access points (both Ruckus Wireless access points and 3rd party access points) that you are managing using the controller.

Topics covered include:

### Viewing a Summary of Access Points

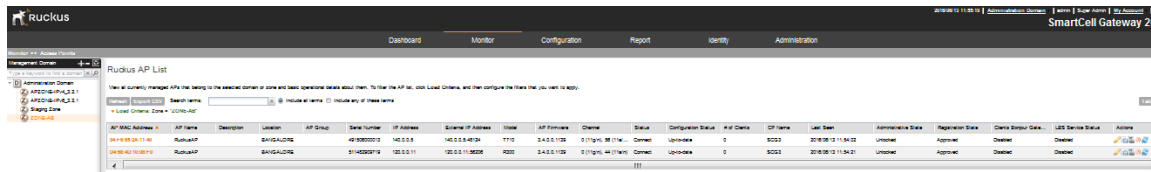
Monitor and view information about the access points (both Ruckus Wireless access points and 3rd party access points) that you are managing using the controller.

Follow these steps to view a summary of existing access points.

1. Go to **Monitor > Access Points**.

The **AP List** page appears and displays a table that lists all existing access points in the selected AP zone.

- If you are using the controller to manage 3rd party access points, the 3rd party AP zones that you created to managed those access points will also appear in the domain tree. Click the 3rd party AP zone name to view all 3rd party access points that belong to that zone.



**Figure 156:** Click an AP zone in the tree to view all access points that belong to it

**NOTE:** Include the key word in the search box and click **Enter** to start search.





[Table 15: Access point details \(Continued\)](#) on page 288 lists the access point details are shown in the table on the AP List page. If the selected zone is a 3rd party AP zone, only the following columns are available.

- **AP MAC Address**
- **Zone**
- **IP Address**
- **# of Clients**
- **Last Seen**

**Table 15: Access point details (Continued)**

Column Name	Description
<b>AP MAC Address</b>	MAC address of the access point. Clicking this link loads a page that displays detailed information about the access point. See <a href="#">Viewing the Configuration of an Access Point</a> on page 290.
<b>AP Name</b>	Name assigned to the access point
<b>Zone</b>	Name of the AP zone to which the access point belongs. Clicking the AP zone name (link) loads a page that displays detailed information about the zone. See <a href="#">Viewing the Configuration of an AP Zone</a> on page 286.
<b>AP Group</b>	Name of the AP group to which the AP belongs
<b>IP Address</b>	Internal IP address assigned to the access point
<b>External IP Address</b>	If the device is behind a NAT server, this is the IP address and port number that the controller will use to communicate with the device.
<b>Model</b>	Model number of the Ruckus Wireless access point
<b>AP Firmware</b>	Firmware version that is installed on the access point



Column Name	Description
<b>Mesh Role</b>	Indicates whether mesh networking is enabled on the access point and the mesh role that is assigned to it. Possible values include:  Disabled: Mesh networking is disabled.  Mesh AP  Root AP  eMesh AP
<b>Mesh Mode</b>	If mesh networking is enabled, this indicates the mesh role (Root AP, Mesh AP, or Disable) of the AP
<b>Channel</b>	Indicates the radio channels used by the AP to provide WLAN services
<b>Status</b>	Indicates whether the access point is currently connected (online) or disconnected (offline)
<b># of Clients</b>	Indicates the number of wireless clients that are currently associated with the access point. Clicking the number of clients (link, except when zero) loads a page that displays detailed information about the wireless clients. See <a href="#">Viewing a Summary of Wireless Clients</a> on page 294.
<b>Last Seen</b>	Indicates the date and time when the access point last reported to the controller
<b>Provision Stage</b>	
<b>Administrative State</b>	Shows either <i>Locked</i> or <i>Unlocked</i> .
<b>Registration State</b>	Shows either <i>Discovery</i> , <i>Approved</i> , or <i>Rejected</i> .
<b>Actions</b>	Icons for actions that you can perform, including:   – Click to view detailed configuration of this access point.   – Click to download the support log from this access point. See <a href="#">Downloading the Support Log from an Access Point</a> on page 291.   – Click to run network connectivity tests (PING and traceroute) on this access point.   – Click to restart the access point.

Column Name	Description
	 <p>- Click to request the AP to upload the crash dump.</p>

## Exporting the Access Point List to CSV

Follow these steps to export the access point list to a CSV file.

1. Go to **Monitor > Access Points**.
2. Click the **Export CSV** button in the content area.

The following message appears: Downloading AP Data. Please wait...

3. When the message disappears, check the default download folder of your web browser and look for a file named `aps.csv`.
4. Use a spreadsheet application (for example, Microsoft Excel®) to view the contents of the CSV file.

You have completed exporting the access point list to CSV.

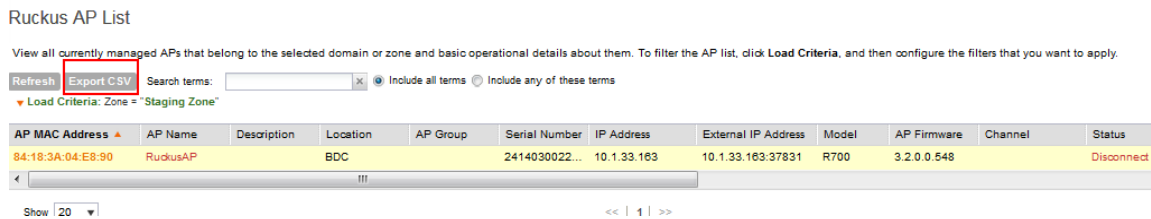


Figure 157: Click Export CSV to download the AP list

## Viewing the Configuration of an Access Point

Follow these steps to view the configuration of an access point.

1. Go to **Monitor > Access Points**.
2. On the **AP List** page, locate the access point whose details you want to view.
3. Click the AP MAC address to view the AP status information, which includes:
  - **General AP information**
  - **Status summary**
  - **Radio information**
  - **WLANs**
  - **LAN port status**
  - **Outstanding alarms** For information on how to clear or acknowledge alarms, see [Clearing Alarms](#) on page 307.
  - **Events**
4. To edit the AP configuration details, click **View AP Configuration**.

The page refreshes and displays the AP zone configuration details (shown in Figure 154).


The screenshot shows the 'Edit AP: [84:18:3A:04:E8:90]' configuration page. It has two tabs: 'AP Configuration' (selected) and 'Swap Configuration'. The 'General Options' section includes fields for AP Name (RuckusAP), Description, Location (with an 'Override zone configuration' checkbox and 'BDC' value), Location Additional Information (with an 'Override zone configuration' checkbox), GPS Coordinates (Latitude: 12.96014, Longitude: 77.6436), Country Code (United States), User Location Information (ULI) (Area Code: 255, Cell Identifier), and AP Admin Logon (with 'Override zone configuration' checkbox, Logon ID, and Password fields). The 'Radio Options' section is divided into two columns. The left column is for 'Radio Options b/g/n (2.4 GHz)' and includes Channel Range (2.4G) with an 'Override zone configuration' checkbox and checkboxes 1-11, Channel Range (5G) with an 'Override zone configuration' checkbox, and settings for Channelization (Auto), Channel (Auto), TX Power Adjustment (Full/Auto), WLAN Group (default), and WLAN Service (checked 'Enable the WLAN service on this radio'). The right column is for 'Radio Options a/n (5 GHz)' and includes Channelization (Auto), Channel (149), TX Power Adjustment (Full/Auto), WLAN Group (default), and WLAN Service (checked 'Enable the WLAN service on this radio').

Figure 158: The AP Configuration tab shows the access point's configuration details

## Downloading the Support Log from an Access Point

If you are experiencing issues with an access point, Ruckus Wireless® Support may request you to download the support log from the access point.

The support log contains important technical information that may help Ruckus Wireless® Support troubleshoot the issue with the access point. Follow these steps to download the support log from an access point.

1. Go to **Monitor > Access Points**.
2. On the **AP List** page, locate the access point from which you want to download the support log.
3. Under the **Actions** column, click the  icon that is in the same row as the MAC address of the access point.

The following message appears: Downloading support log file. Please wait...

4. When the message disappears, check the default download folder for your web browser and look for a file named `SupportLog_{random-string}.txt`.
5. Use a text editor (for example, Notepad) to view the contents of the text file.
6. Send the support log file to Ruckus Wireless® Support, along with your support request.

You have completed downloading the support log from an access point.

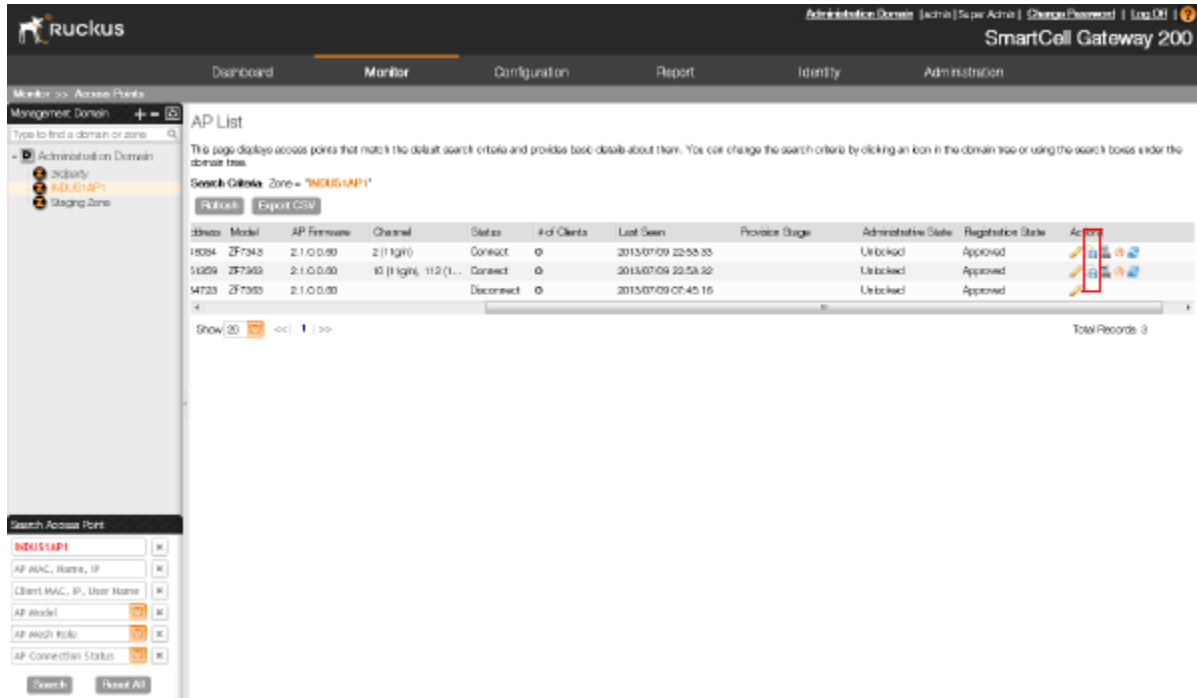



Figure 159: Click the icon for downloading the support log

## Restarting an Access Point Remotely

Follow these steps to restart an access point remotely from the web interface.

1. Go to **Monitor > Access Points**.
2. On the **AP List** page, locate the access point that you want to restart.
3. Click the  icon that is in the same row as the MAC address of the access point.

The following confirmation message appears: Are you sure you want to restart this AP?

4. Click **OK**.

The controller sends a restart command to the access point, and then the access point restarts itself.

You have completed restarting an access point remotely.

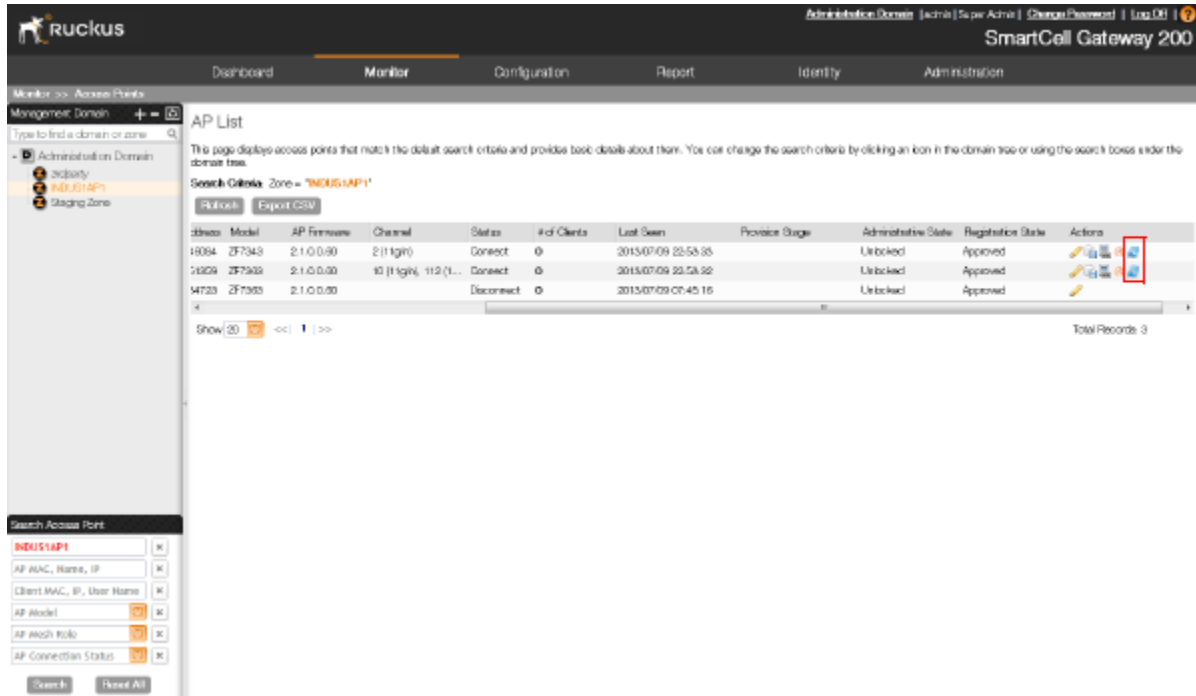



Figure 160: The restart buttons for restarting access points remotely

### Running Ping and Traceroute on an Access Point

The controller web interface provides two commonly used tools – ping and traceroute – that allow you to diagnose connectivity issues on managed access points.

Follow these steps to run the ping and traceroute on an access point.

1. Go to **Monitor > Access Points**.
2. On the **AP List** page, locate the access point on which you want to run the ping or traceroute tool.
3. Click the  icon that is in the same row as the MAC address of the access point.

The **Network Connectivity** window appears.

4. In **IP Address**, type an IP address to check whether the access point can connect to it.  
For example, type 199.238.178.36 if you want to check if the access point can connect to the Ruckus Wireless website.
5. Click either Ping or Trace Route (depending on which test you want to run).

The blank box below is populated with the test results.

You have completed running a ping or traceroute test.

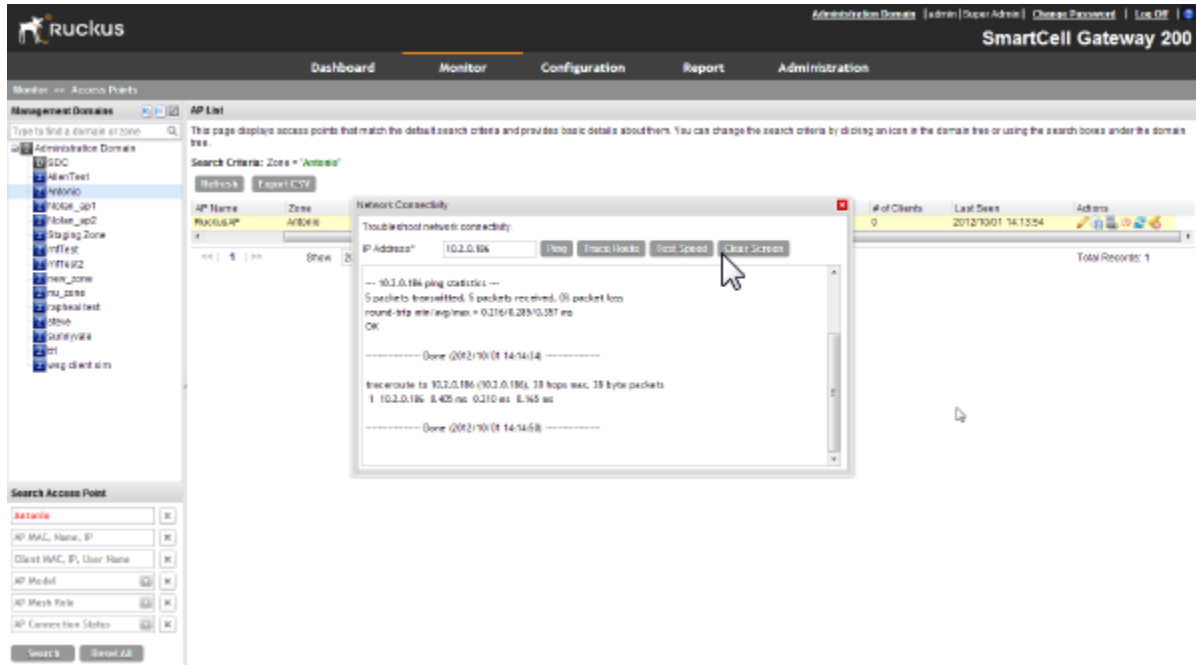


Figure 161: The Network Connectivity window showing both ping and traceroute results

## Monitoring Wireless Clients

This section provides information on how to monitor and view information about wireless clients that associate with the managed access points.

Topics covered include:

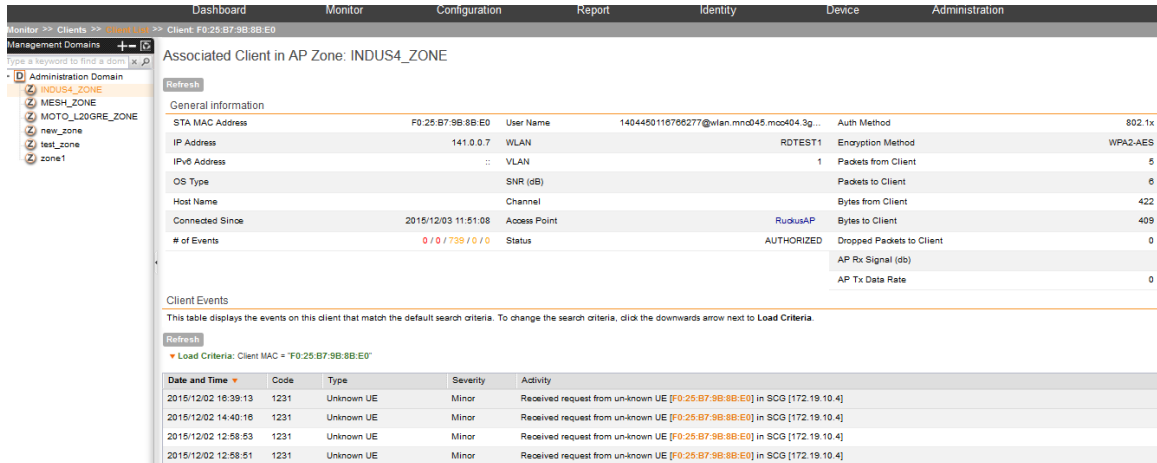
### Viewing a Summary of Wireless Clients

Monitor and view information about wireless clients that associate with the managed access points.


Follow these steps to view a summary of wireless clients that are currently associated with the managed access points.

Go to **Monitor > Clients**.

The **Associated Clients List** page appears and displays a table that lists all access points that are currently associated with the managed access points.




**Figure 162: Select an AP zone in the domain tree to view all wireless clients associated with the APs that belong to the zone**

If you want to view only wireless clients that belong to a particular AP zone (denoted by the  icon in the domain tree), click the AP zone icon. The table refreshes and displays only the wireless clients that belong to that AP zone.

[Table 16: Wireless client details](#) on page 295 lists the wireless client details that are shown in the table.

**Table 16: Wireless client details**

Column Name	Description
<b>STA MAC Address</b>	MAC address of the wireless station. Clicking this link loads a page that displays detailed information about the wireless client. See <a href="#">Viewing Information About a Wireless Client</a> on page 297.
<b>IP Address</b>	IP address assigned to the wireless client
<b>IPv6 Address</b>	IPv6 address assigned to the wireless client
<b>OS Type</b>	Operating system that the wireless client is using
<b>Host Name</b>	Host name of the wireless client
<b>Connected Since</b>	Displays the time from which the AP is connected to the wireless client
<b># of Events</b>	Displays the number of client events
<b>AP Name</b>	Name assigned to the access point. Clicking this link loads a page that displays detailed information about the access point. See <a href="#">Viewing the Configuration of an Access Point</a> on page 290.
<b>WLAN (SSID)</b>	Name of the WLAN service or SSID with which the wireless client is associated.
<b>VLAN</b>	VLAN ID assigned to the wireless client

Column Name	Description
<b>SNR (dB)</b>	Displays the signal to noise ratio in decibels
<b>Channel</b>	Radio channel used by the wireless client to access the WLAN service on the access point
<b>Status</b>	Indicates whether the wireless client is authorized or unauthorized to access the WLAN service
<b>User Name</b>	Name of the user logged on to the wireless client
<b>Auth Method</b>	Authentication method used by the access point
<b>Encryption Method</b>	Encryption method used by the access point
<b>Packets from Client</b>	Displays the number of packets that the AP receives from the wireless client
<b>Packets to Client</b>	Displays the number of data packets the AP sends to the wireless client
<b>Bytes from Client</b>	Displays the amount of data (in bytes) the AP receives from the wireless client
<b>Bytes to Client</b>	Displays the amount of data (in bytes) the AP send to the wireless client
<b>Dropped Packets to Client</b>	Displays the number of data packets dropped during data transmission and reception
<b>AP Rx Signal (dB)</b>	Displays the AP's reception signal strength in decibels
<b>AP Tx Data Rate</b>	Displays the rate at which data is transmitted by the AP to the wireless client
<b>Actions</b>	Icons for actions that you can perform, including:   – Click to disconnect the wireless client from the access point.

**NOTE:** The client is automatically unauthenticated by the WLAN if the client is connected for 48 hours in the *Standard+Open/ Standard+MAC Auth* authentication method, and for 12 hours in the *Standard+802.1x EAP* authentication method.

## Exporting the Wireless Client List to CSV

Follow these steps to export the access point list to a CSV file.

1. Go to **Monitor > Clients**.
2. Click the **Export CSV** button in the content area.  
The following message appears: *Downloading Client Data. Please wait...*
3. When the message disappears, check the default download folder for your web browser and look for a file named `clients.csv`.
4. Use a spreadsheet application (for example, Microsoft Excel®) to view the contents of the CSV file.



You have completed exporting the client list to CSV.

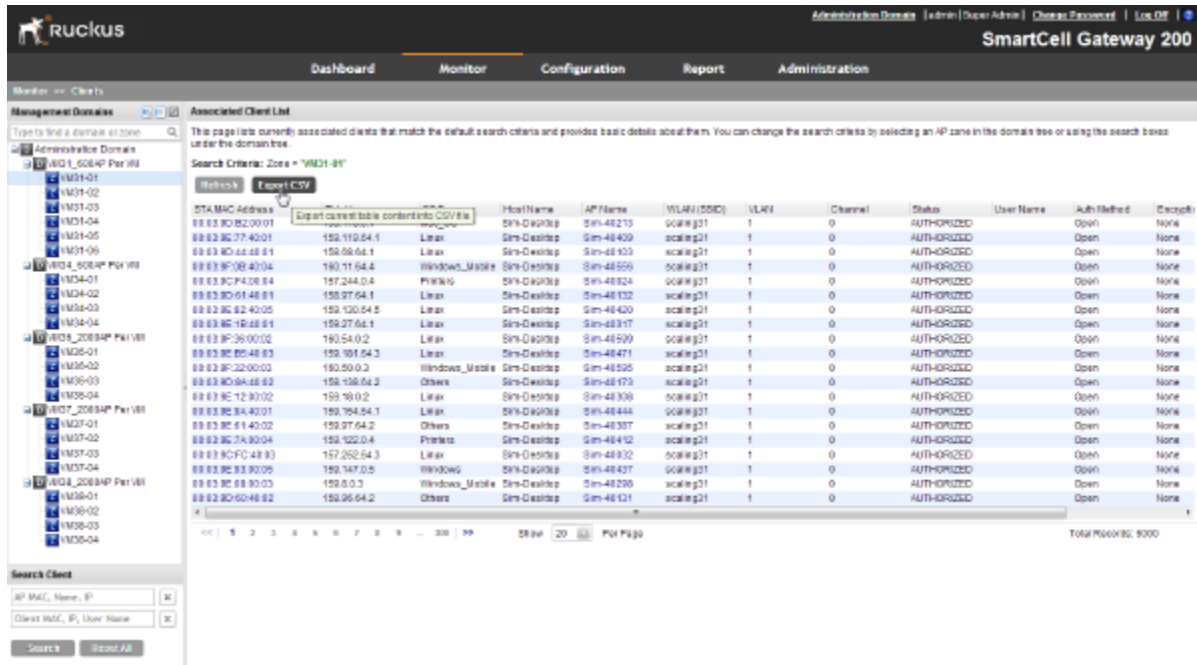


Figure 163: A message appears as your browser downloads the CSV file from the controller

## Viewing Information About a Wireless Client

Follow these steps to view information about a wireless client.

1. On the **Clients List** page, locate the wireless client whose details you want to view.
2. Under the **STA MAC Address** column, click the MAC address of the wireless client.

The page refreshes and displays general information about the wireless client, including its MAC address, IP address, authentication method, encryption method, connection details, operating system, and traffic statistics, among others. Recent connectivity events that occurred on the wireless client are displayed in the Events section at the bottom of the page.

The screenshot shows the 'Monitor >> Clients >> Client List' page for client F0:25:B7:9B:8B:E0. The left sidebar shows a tree view of Management Domains under 'Administration Domain', with 'INDUS4\_ZONE' selected. The main content area is titled 'Associated Client in AP Zone: INDUS4\_ZONE' and contains a 'General information' table and a 'Client Events' table.

**General information**

STA MAC Address	F0:25:B7:9B:8B:E0	User Name	
IP Address	141.0.0.7	VLAN	WLAN
IPv6 Address	::	VLAN	
OS Type		SNR (dB)	
Host Name		Channel	
Connected Since	2015/12/03 11:51:08	Access Point	
# of Events	0 / 0 / 739 / 0 / 0	Status	

**Client Events**

This table displays the events on this client that match the default search criteria. To change the search criteria, click the Load Criteria button.

Load Criteria: Client MAC = "F0:25:B7:9B:8B:E0"

Date and Time	Code	Type	Severity	Activity
2015/12/02 16:39:13	1231	Unknown UE	Minor	Received request
2015/12/02 14:40:16	1231	Unknown UE	Minor	Received request
2015/12/02 12:58:53	1231	Unknown UE	Minor	Received request
2015/12/02 12:58:51	1231	Unknown UE	Minor	Received request

Figure 164: Page showing the wireless client information

### Measuring Wireless Network Throughput with SpeedFlex


SpeedFlex is a wireless performance tool included in the controller that you can use to measure the downlink throughput between the controller and an AP.

When performing a site survey, you can use SpeedFlex to help find the optimum location for APs on the network with respect to user locations.

**NOTE:** SpeedFlex is unable to measure the throughput between two devices if those two devices are not on the same VLAN or the same subnet.

Follow these steps to measure the throughput of an AP from the controller web interface.

1. Find out the MAC address of the AP that you want to use for this test procedure.
2. Log on to the controller web interface.
3. If you want to test AP throughput, click **Monitor > Access Points**.

- On the list of APs, look for the MAC address of the AP that you want to test, and then click  (SpeedFlex icon) that is in the same row.

The **SpeedFlex Wireless Performance Test** interface loads, showing a speedometer and the IP address of the AP that you want to test.

- In **Protocol**, select **UDP**.

If you are testing AP throughput, you have the option to test both **Downlink** and **Uplink** throughput. Both options are selected by default. If you only want to test one of them, clear the check box for the option that you do not want to test.

- Click the **Start** button.

A progress bar appears below the speedometer as SpeedFlex generates traffic to measure the downlink or uplink throughput. One throughput test typically runs for 10-30 seconds. If you are testing AP throughput and you selected both the **Downlink** and **Uplink** options, both tests should take about one minute to complete.

When the tests are complete, the results appear below the **Start** button. Information that is shown includes the downlink/uplink throughput and the packet loss percentage during the tests.

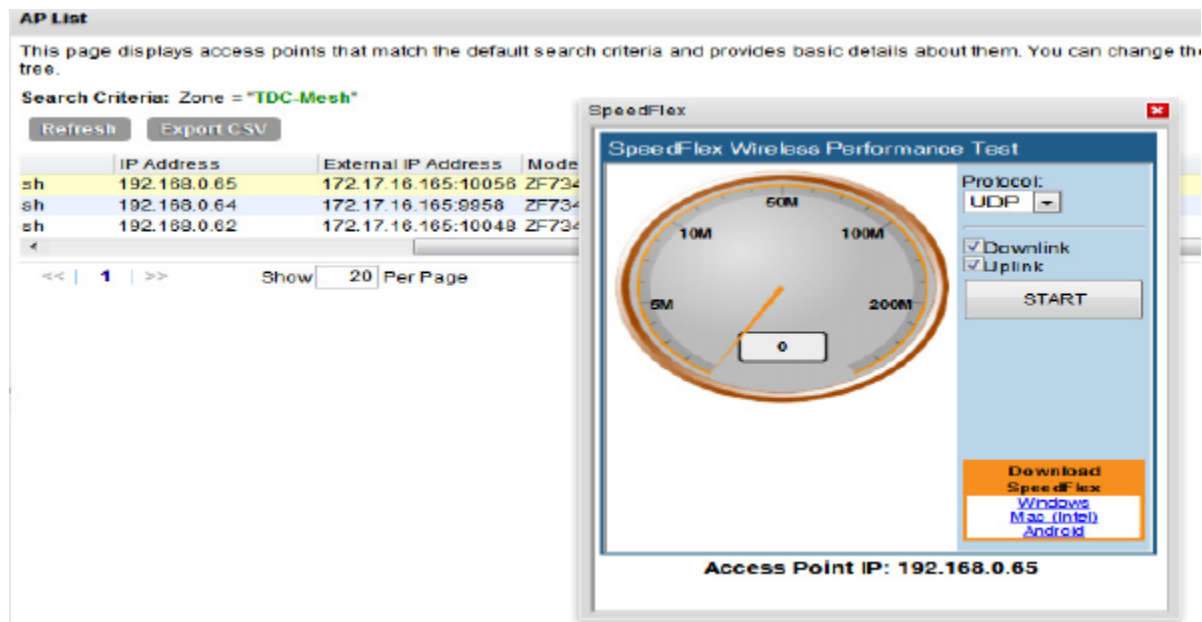


Figure 165: The SpeedFlex page

# Monitoring the System, Alarms, Events, and Administrator Activity

# 13

In this chapter:

- [Monitoring the Controller System](#)
- [Monitoring Rogue Access Points](#)
- [Viewing Alarms](#)
- [Viewing Events](#)
- [Viewing Administrator Activity](#)

In this chapter:

## Monitoring the Controller System

This section provides information on how to view information about the status of the controller system, including its cluster planes and cluster events. It also describes how to use the chassis view and to start the cluster monitor.

Topics covered include:

### Viewing the System Cluster Overview

The system cluster overview provides summary information about the cluster name, control planes and data planes on the controller appliance, any outstanding cluster alarms, and the latest cluster events.

- To view the system cluster overview, go to **Monitor > System**. The **System Cluster Overview** page appears, as shown in [Figure 166: The System Cluster Overview page](#) on page 301.

You can view the cluster name using the `show cluster name` command. You can also change the cluster name using the `cluster name <new cluster name>` command. However, you can change the cluster name in stand alone, two node, three node and four node clusters on SCG-200 and vSZ-H.

System Cluster Overview: Vscg370

Refresh Start Cluster Real-time Monitor

**Control Planes**  
View existing control planes and basic information about them. To view detailed information about a specific control plane, click the control plane name.

Name	MAC Address	Model	Serial Number	# of APs	Description
Vscg370-C	00:0C:29:52:BE:8D	vSZ-H	982MT5N4H4...	1	Vscg370

**Data Planes**  
This table displays existing data planes and provides basic information about them. Click the data plane name to view detailed plane information.

Name	DP MAC Address	Data IP	Data External IP	Data External Port	Data VLAN	Management IP	Management External IP	Management External Port
---								

**Outstanding Cluster Alarms**  
This table lists the outstanding alarms on this cluster that match the default search criteria. To change the search criteria, click the downwards arrow next to Load Criteria.

Refresh Export CSV Clear Alarm Acknowledge Alarm

▼ Load Criteria: Source = "System Cluster" && Status = "Outstanding"

<input type="checkbox"/>	Date and Time	Code	Alarm Type	Severity	Status	Acknowledged On	Activity
<input type="checkbox"/>	2015/10/07 13:06:44	809	Node bond interface down	Major	Outstanding	N/A	Network interface [Cluster] on node [Vscg370] is down.
<input type="checkbox"/>	2015/10/07 13:06:41	810	Node physical interface down	Critical	Outstanding	N/A	Physical network interface [eth0] on node [Vscg370] is down.

Show 10 << | 1 | >>

**Cluster Events**  
This table displays the events on this cluster that match the default search criteria. To change the search criteria, click the downwards arrow next to Load Criteria.

Refresh

▼ Load Criteria: Source = "System Cluster" && Category = "Cluster"

Date and Time	Code	Type	Severity	Activity
2015/10/07 14:11:10	835	Node back in service	Informational	Node [Vscg370] in cluster [Vscg370] is in service.
2015/10/07 14:10:40	801	Cluster created successfully	Informational	Cluster [Vscg370] created with node [Vscg370].

Figure 166: The System Cluster Overview page

### Displaying the Chassis View of Cluster Nodes

The chassis view provides a graphical representation of the control panel (on the front panel of the controller) and the rear panel of each controller node, including their LEDs.

Use the LEDs to check the status of the ports and power supplies on the controller. Fan status is also displayed on the chassis view.

- To view the chassis of the cluster node, click **Cluster Chassis View** on the **System Cluster Overview** page.

**NOTE:** The information on the chassis view updates automatically every 30 seconds. This polling frequency is not configurable.

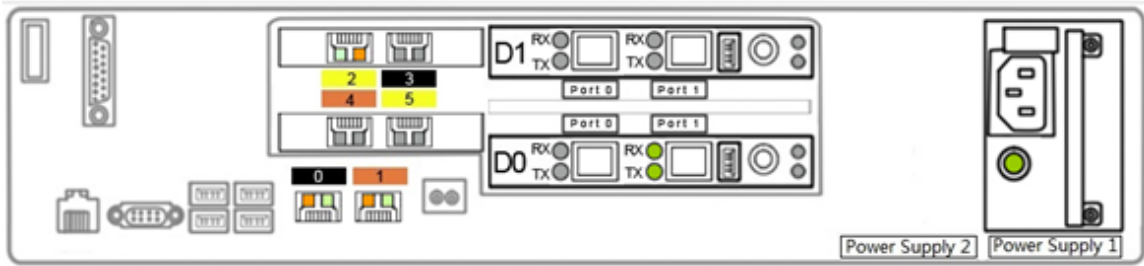


Figure 167: The chassis view page displaying the chassis of all nodes in the cluster

## Starting the Cluster Real-time Monitor

The **Cluster Real-time Monitor** displays graphs and charts of the controller system resources. Use this monitor to understand how system resources on the cluster nodes are being used.

1. To start the cluster real-time monitor, click **Start Cluster Real-time Monitor** on the **System Cluster Overview** page.

A new browser page or tab appears (depending on your browser settings), and then the **Cluster Real-time Monitor** page appears.



Figure 168: The Cluster Real-time Monitor page

The resource graphs and charts that are shown on the **Cluster Real-time Monitor** page include:

- CPU Usage
- Memory Usage
- Disk Usage
- Control Tx (Port0, Port 3)
- Cluster Tx (Port1, Port 4)
- Management Tx (Port2, Port 5)
- Control Rx (Port0, Port 3)
- Cluster Rx (Port1, Port 4)

- **Management Rx (Port2, Port5)**

2. To stop the **Cluster Real-time Monitor**, click the **Stop Monitoring** button on the upper-left part of the page.

## Monitoring Rogue Access Points

Rogue (or unauthorized) APs pose problems for a wireless network in terms of airtime contention, as well as security.

Usually, a rogue AP appears in the following way: an employee obtains another manufacturer's AP and connects it to the LAN, to gain wireless access to other LAN resources. This would potentially allow even more unauthorized users to access your corporate LAN - posing a security risk. Rogue APs also interfere with nearby Ruckus Wireless APs, thus degrading overall wireless network coverage and performance.

The controller's rogue AP detection options include identifying the presence of a rogue AP, categorizing it as either a known neighbor AP or as a malicious rogue.

If you enabled rogue AP detection when you [created an AP zone](#), click **Monitor > Rogue Access Points**. The Rogue Access Points page displays all rogue APs that the controller has detected on the network, including the following information:

- **Rogue MAC:** MAC address of the rogue AP.
- **Type:** Type of rogue AP detected. Possible values include:
  - **Rogue:** A normal rogue AP. This rogue AP has not yet been categorized as malicious or non-malicious.
  - **Malicious AP (SSID-spoof):** A malicious rogue AP that uses the same SSID as a controller-managed AP (also known as an Evil-twin AP).
  - **Malicious AP (MAC-spoof):** A malicious rogue AP that has the same BSSID (MAC) as one of the virtual APs managed by the controller.
  - **Malicious AP (Same-Network):** A malicious rogue AP that is connected to the same wired network.
- **Channel:** Radio channel used by the rogue AP.
- **Radio:** WLAN standards with which the rogue AP complies.
- **SSID:** WLAN name that the rogue AP is broadcasting.
- **Encryption:** Indicates whether the wireless signal is encrypted or not.
- **Last Detected:** Date and time when the rogue AP was last detected by the controller.

## Rogue Access Points

View a list of unknown access points that could pose a security threat if connected to the local network.

Refresh Search terms:  X  Include all terms  Include any of these terms

	Rogue MAC	Type	Channel	Radio	SSID
	0C:47:3D:D3:F9:58	Rogue	2	802.11 g/h	Penguins
	0C:47:3D:D3:F9:5B	Rogue	2	802.11 g/h	
	68:15:90:45:E2:2A	Malicious AP (Same-Network)	6	802.11 g/h	temporary
	90:F6:52:F0:CB:0A	Rogue	10	802.11 g/h	linksys34
	E4:D5:3D:64:C4:4D	Rogue	8	802.11 g/h	HP-Print-4D-LaserJet M1217
	E8:40:F2:4B:20:CA	Rogue	11	802.11 g/h	Casey
	EA:40:F2:4B:20:CB	Rogue	11	802.11 g/h	

Show 20 << | 1 | >>

Figure 169: View a list of rogue APs on the Monitor > Rogue Access Points page

## Viewing Alarms

Alarms are a type of event that typically warrants your attention. Alarms are generated by managed access points and the controller system (control plane and data plane).

Follow these steps to view recent alarms that have been generated.

- 

Go to **Monitor > Alarms**.

The **Alarms** page displays the 20 most recent alarms.

**NOTE:** By default, the Alarms page displays up to 20 event entries per page. You can change the number of alarms to display per page by selecting a number in Show. Options range from 10 to 250 entries per page. Alternatively, you can click the >> (next) link to display the next 20 alarms on another page.

2015/10/14 08:44:40 | Administration Domain | admin | Super Admin | My As  
SmartCell Gateway 200

Dashboard Monitor Configuration Report Identity Device Administration

Monitor >> Alarms

Alarms

View a list of all alarms saved on the controller. To filter the alarm list, click Load Criteria, and then configure the filters that you want to apply.

Refresh Export CSV Clear Alarm Acknowledge Alarm

▲ Load Criteria: Category = 'AP Authentication' && AP MAC = 'RuckusAP@6C-AA-B3:12:49:80' && Status = 'Outstanding'

+  
 X Category is AP Authentication  
 X Source is Access Point Search AP by AP MAC is RuckusAP@6C-AA-B3:12:49:80  
 X Status is Outstanding

Load Data Reset All

Date and Time	Code	Alarm Type	Severity	Status	Acknowledged On	Activity	Actions
2015/10/08 11:44:45	2102	Radius server unreachable	Major	Outstanding	N/A	AP [RuckusAP@6C-AA-B3:12:49:80] is unable to reach radius server [10.1.13.44]	

Show 250 << | 1 | >>

Figure 170: The Alarm page, displaying alarms in the DataPlane category



Table 17: Alarm details (Continued) on page 305 lists the alarm details that are displayed on the **Alarms** page.

**Table 17: Alarm details (Continued)**



Column Name	Description
Date and Time	Date and time when the alarm was triggered
Code	Alarm code (see the Alarm and Reference Guide for your controller platform for more information)
Alarm Type	Type of alarm event that occurred (for example, AP reset to factory settings)
Severity	Severity level assigned to the alarm. Possible values include (from most severe to least severe):  Critical  Major  Minor  Warning
Status	Indicates whether the alarm has already been cleared or still outstanding
Acknowledged On	Date and time when you or another administrator acknowledge the alarm
Activity	Displays additional details about the alarm, including (if available) the specific access point, control plane, or data plane that triggered the alarm
Actions	Icons for actions that you can perform, including:  – Click this to take ownership of issue. Acknowledging an alarm lets other administrators know that someone is already looking into the issue.  – Click this to clear the alarm. You may clear an alarm to let other administrators know that you have already resolved the issue. When you click this icon, a text box appears where you can enter comments or notes about the resolved issue. Click <b>Clear</b> when done.


### Using the Search Criteria Section

By default, the controller displays alarms triggered on all access points (using **All APs** as the search criteria) when you load the **Alarms** page.

If you want to filter the alarms that are displayed on the page (for example, you want to display only critical alarms), use the **Search Criteria** section.

Follow these steps to filter alarms.

1. Click the gray down button next to **Search Criteria** to expand the section.
2. In the **Source** filter, select source from which to search alarms.  
Options include **Access Point** and **System**.
3. Click the  icon to add another filter. Available filters include (in the order that they appear when you click the  icon):
  - Severity
  - Triggered Time
  - Status
  - Acknowledge Time
  - Type

**NOTE:** You do not need to use all these filters. To remove a filter from the search criteria, click the  icon next to the filter that you want to delete.
4. Define the filters that you want to use.  
For example, if you want to view all critical alarms on all access points, select **Access Point** in **Source**, and then select **Critical** in **Severity**.
5. Click **Search**.  
The page refreshes and displays the alarms that match the search criteria that you defined.

## Exporting the Alarm List to CSV

Follow these steps to export the alarm list to a CSV file.

1. Go to **Monitor > Alarms**.
2. Click the **Export CSV** button in the content area.  
The following message appears: `Downloading Alarms Data. Please wait...`
3. When the message disappears, check the default download folder of your web browser and look for a file named `alarms.csv`.
4. Use a spreadsheet application (for example, Microsoft Excel®) to view the contents of the CSV file.

You have completed exporting the alarm list to CSV.

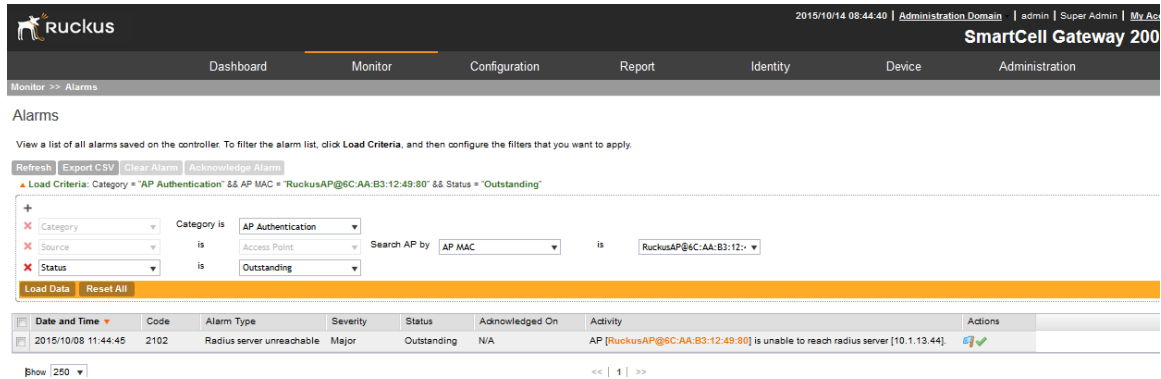



Figure 171: A message appears as your browser downloads the CSV file from the controller

## Clearing Alarms

Clearing an alarm removes the alarm from the list but keeps it on the controller's database.


Do one of the following to clear a single alarm or multiple alarms.

- To clear a single alarm, select the check box that is in the same row as the alarm, and then click **Clear Alarm**. Alternatively, click the  icon.
- To clear multiple alarms, select the check boxes for the alarm that you want to clear, and then click **Clear Alarm**.
- To clear all alarms that are currently displayed on the page, click the check box before the **Date and Time** column, and then click **Clear Alarm**.

## Acknowledging Alarms

Acknowledging an alarm lets other administrators know that you have examined the alarm. After you acknowledge an alarm, it will remain on the list of alarms and will show the date and time that you acknowledged it.

Do one of the following to acknowledge a single alarm or multiple alarms.

- To acknowledge a single alarm, select the check box that is in the same row as the alarm, and then click **Acknowledge Alarm**. Alternatively, click the  icon.
- To acknowledge multiple alarms, select the check boxes for the alarm that you want to clear, and then click **Acknowledge Alarm**.
- To acknowledge all alarms that are currently displayed on the page, click the check box before the **Date and Time** column, and then click **Acknowledge Alarm**.

## Viewing Events

An event is an occurrence or the detection of certain conditions in and around the network.

An AP being rebooted, an AP changing its IP address, and a user updating an AP's configuration are all examples of events.

**NOTE:** Events that require your attention are called alarms. For information on alarms, refer to [Viewing Alarms](#) on page 304.

Follow these steps to view recent events that have been detected by the controller.

Go to **Monitor > Events**.

The **Events** page appears and displays the 20 most recent events that have occurred.

**NOTE:** By default, the **Events** page displays up to 20 event entries per page. You can change the number of events to display per page by selecting a number in Show. Options range from 10 to 250 entries per page. Alternatively, you can click the >> (next) link to display the next 20 events on another page.

The screenshot shows the Ruckus web interface. At the top, there's a navigation bar with 'Dashboard', 'Monitor', 'Configuration', 'Report', and 'Identity'. Below that, the 'Monitor >> Events' breadcrumb is visible. The main heading is 'Events'. Below the heading, there's a sub-header: 'View a list of all events saved on the controller. To filter the event list, click **Load Criteria**, and then configure the filters that you want to apply.' There are 'Refresh' and 'Export CSV' buttons. A 'Load Criteria' section shows filters: 'Category = "AP Authentication" && AP MAC = "RuckusAP@6C:AA:B3:12:49:80"'. Below this, there are dropdown menus for 'Category' (set to 'AP Authentication'), 'Source' (set to 'Access Point'), and 'Search AP by' (set to 'AP MAC'). The 'RuckusAP@6C:AA:B3:12:4' MAC address is entered in the search field. There are 'Load Data' and 'Reset All' buttons. Below the filters is a table of events:

Date and Time	Code	Type	Severity	Activity
2015/10/08 11:44:45	2102	Radius server unreachable	Major	AP [RuckusAP@6C:AA:B3:12:49:80] is unable to reach radius server [10.1.13.44]

**Figure 172:** The Events page lists the most recent events that have occurred

[Table 18: Event details](#) on page 308 lists the event details that are displayed on the **Events** page.

**Table 18: Event details**

Column Name	Description
<b>Date and Time</b>	Date and time when the event occurred
<b>Code</b>	Event code (see the <i>Alarm and Event Reference Guide</i> for your controller platform more information)
<b>Event Type</b>	Type of event that occurred (for example, AP configuration updated)
<b>Severity</b>	Severity level assigned to the event. Possible values include (from most severe to least severe):  Critical  Major



Column Name	Description
	Minor Warning
<b>Activity</b>	Displays additional details about the event, including (if available) the specific access point, control plane, or data plane that triggered the event


### Using the Search Criteria Section

By default, the controller displays all events that occurred on the first access point that is listed in the domain tree.

If you want to filter the events that are displayed on the page (for example, you want to display events on a client or the controller system), use the **Search Criteria** section.

Follow these steps to filter events.

1. Click the gray down button next to **Search Criteria** to expand the section.
2. In the **Source** filter, select source from which to search alarms.  
Options include **Access Point**, **Client**, and **SCG System**.
3. Click the  icon to add another filter. Available filters include (in the order that they appear when you click the  icon):
  - **Date and Time**
  - **Severity**
  - **Type**

**NOTE:** You do not need to use all these filters. To remove a filter from the search criteria, click  the icon next to the filter that you want to delete. The search criteria are case-sensitive.

4. Define the filters that you want to use.  
For example, if you want to view all critical events on all access points, select **Access Point** in **Source**, leave **Search Plane by** blank, and then select **Critical** in **Severity**.
5. Click **Search**.

The page refreshes and displays the events that match the search criteria that you defined.

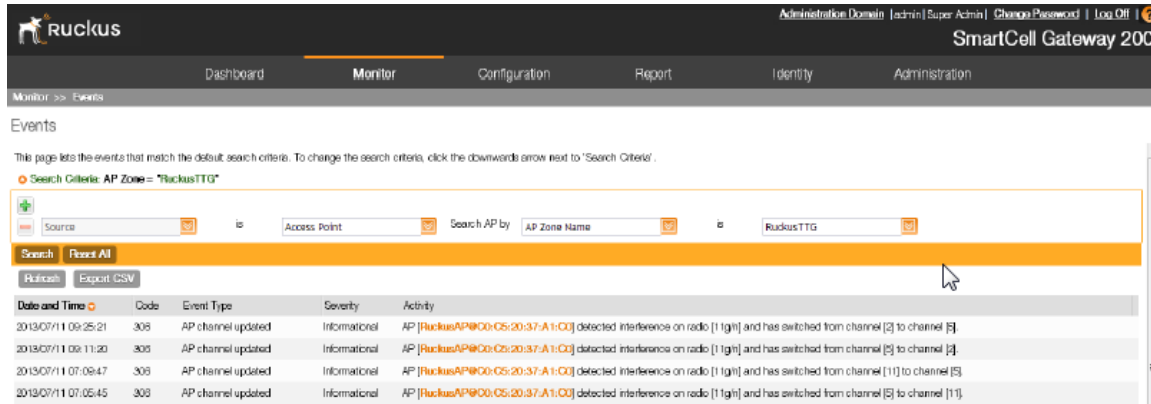


Figure 173: Define the filters that you want to use to search for events

### Exporting the Event List to CSV

Follow these steps to export the event list to a CSV file.

1. Go to **Monitor > Events**.
2. Click the **Export CSV** button in the content area.

The following message appears: Downloading Events Data. Please wait...

3. When the message disappears, check the default download folder of your web browser and look for a file named `events.csv`.
4. Use a spreadsheet application (for example, Microsoft Excel®) to view the contents of the CSV file.

You have completed exporting the event list to CSV.

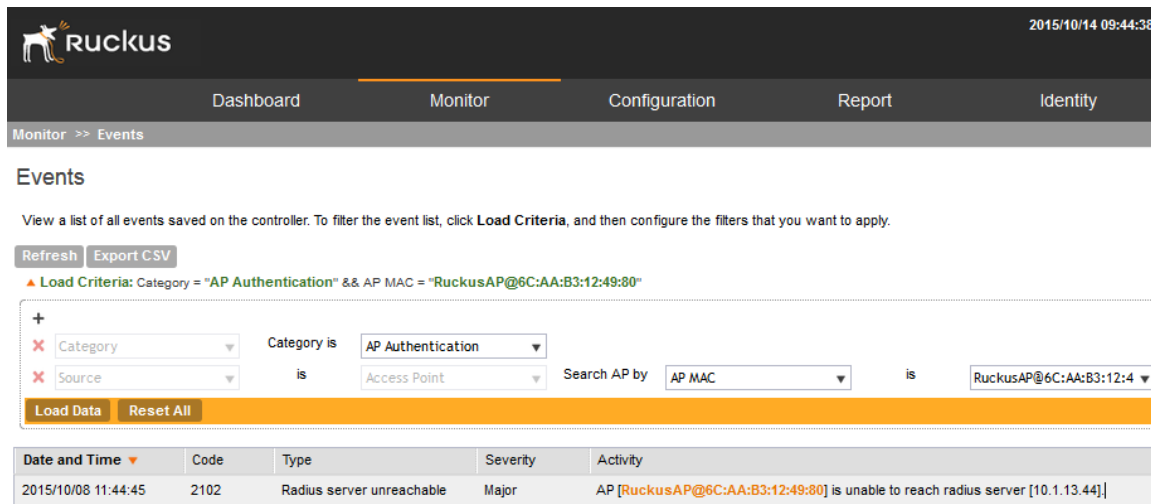


Figure 174: Exporting the event list to CSV

## Viewing Administrator Activity

The controller keeps a record of all actions and configuration changes that administrators perform on the server. This feature enables you and other administrators in the organization to determine what changes were made to the controller and by whom.

Follow these steps to view a record of actions that were performed by administrators.

Go to **Monitor > Administrator Activity**.

The **Administrator Activity List** page displays the 20 most recent administrator actions.

**NOTE:** By default, the **Administrator Activity List** page displays up to 20 administrator actions per page. You can change the number of administrator actions to display per page by selecting a number in Show. Options range from 10 to 250 entries per page. Alternatively, you can click the >> (next) link to display the next 20 administrator actions on another page.

Date and Time	Administrator	Source IP	Action	Resource	Description
2015/10/13 15:53:48	admin	172.19.13.125	Delete	AP Zone	Zone [sevit-zone-m3YJuvVO] deleted.
2015/10/13 15:53:48	admin	172.19.13.125	Log on	Administrator	Administrator [admin] logged on from [172.19.13.125].
2015/10/13 15:53:47	admin	172.19.13.125	Log on	Administrator	Administrator [admin] logged on from [172.19.13.125].
2015/10/13 15:52:46	admin	172.19.13.125	Update	Access Point	AP [RuckusAP@6C-AA-B3-12-49-80] configuration updated.
2015/10/13 15:52:46	admin	172.19.13.125	Log on	Administrator	Administrator [admin] logged on from [172.19.13.125].
2015/10/13 15:52:46	admin	172.19.13.125	Log on	Administrator	Administrator [admin] logged on from [172.19.13.125].
2015/10/13 15:52:44	admin	172.19.13.125	Log on	Administrator	Administrator [admin] logged on from [172.19.13.125].
2015/10/13 15:52:44	admin	172.19.13.125	Log on	Administrator	Administrator [admin] logged on from [172.19.13.125].
2015/10/13 15:52:23	admin	172.19.13.125	Log on	Administrator	Administrator [admin] logged on from [172.19.13.125].
2015/10/13 15:52:23	admin	172.19.13.125	Log on	Administrator	Administrator [admin] logged on from [172.19.13.125].
2015/10/13 15:51:23	admin	172.19.13.125	Update	Access Point	AP [RuckusAP@6C-AA-B3-12-49-80] configuration updated.
2015/10/13 15:51:22	admin	172.19.13.125	Update	WLAN	WLAN [sevit-wlan-qd7n4DMC] of zone [sevit-zone-m3YJuvVO] updated.
2015/10/13 15:51:22	admin	172.19.13.125	Update	WLAN	WLAN [sevit-wlan-qd7n4DMC] of zone [sevit-zone-m3YJuvVO] updated.
2015/10/13 15:51:22	admin	172.19.13.125	Create	WLAN	WLAN [sevit-wlan-qd7n4DMC] of zone [sevit-zone-m3YJuvVO] created.
2015/10/13 15:51:22	admin	172.19.13.125	Log on	Administrator	Administrator [admin] logged on from [172.19.13.125].
2015/10/13 15:51:22	admin	172.19.13.125	Log on	Administrator	Administrator [admin] logged on from [172.19.13.125].
2015/10/13 15:50:20	admin	172.19.13.125	Update	Access Point	AP [RuckusAP@6C-AA-B3-12-49-80] configuration updated.
2015/10/13 15:50:19	admin	172.19.13.125	Log on	Administrator	Administrator [admin] logged on from [172.19.13.125].
2015/10/13 15:50:19	admin	172.19.13.125	Log on	Administrator	Administrator [admin] logged on from [172.19.13.125].
2015/10/13 15:49:05	admin	172.19.13.125	Log on	Administrator	Administrator [admin] logged on from [172.19.13.125].

Figure 175: The Administrator Activity List displays the most recent administrator actions

Table 19: Administrator activity details on page 312 lists the administrator activity details that are displayed on the **Administrator Activity List** page.



**Table 19: Administrator activity details**


Column Name	Description
<b>Date and Time</b>	Date and time when the alarm was triggered
<b>Administrator</b>	Name of the administrator who performed the action
<b>Browser IP</b>	IP address of the browser that the administrator used to log on to the controller
<b>Action</b>	Action performed by the administrator
<b>Resource</b>	Target of the action performed by the administrator. For example, if the action is <code>Create</code> and the object is <code>hotspot portal</code> , this means that the administrator created a new hotspot portal.
<b>Description</b>	Displays additional details about the action. For example, if the administrator created a new hotspot portal, this column may show the following:  <code>Hotspot [company_hotspot] created</code>

### Using the Search Criteria Section

By default, the controller displays the 30 most recent administrator actions when you load the **Administrator Activity List** page.

If you want to filter the actions that are displayed on the page (for example, you want to display only actions that were performed by a particular admin), use the **Search Criteria** section.

1. Click the gray down button next to **Search Criteria** to expand the section.
2. Click the  icon to add a filter. Available filters include (in the order that they appear when you click the  icon:
  - **Date/Time**
  - **Administrator**
  - **Browser IP**
  - **Object**

**NOTE:** You do not need to use all these filters. To remove a filter from the search criteria, click  the icon next to the filter that you want to delete. The search criteria are case-sensitive.

3. Define the filters that you want to use.  
For example, if you want to view all actions performed by a particular administrator for the past month, define the date and time, and then select the name of the administrator in **Administrator**.
4. Click **Search**.



The page refreshes and displays the administrator actions that match the search criteria that you defined.

Administrator Activity List

Refresh Export CSV

▲ Load Criteria:

+  
Load Data Reset All

Date and Time	Administrator	Source IP	Action	Resource	Description
2015/10/13 15:53:48	admin	172.19.13.125	Delete	AP Zone	Zone [devit-zone-m3YJurVO] deleted.
2015/10/13 15:53:48	admin	172.19.13.125	Log on	Administrator	Administrator [admin] logged on from [172.19.13.125].
2015/10/13 15:53:47	admin	172.19.13.125	Log on	Administrator	Administrator [admin] logged on from [172.19.13.125].
2015/10/13 15:52:46	admin	172.19.13.125	Update	Access Point	AP [RuckusAP@6C-AA-B3:12:49:80] configuration updated.
2015/10/13 15:52:46	admin	172.19.13.125	Log on	Administrator	Administrator [admin] logged on from [172.19.13.125].
2015/10/13 15:52:46	admin	172.19.13.125	Log on	Administrator	Administrator [admin] logged on from [172.19.13.125].
2015/10/13 15:52:44	admin	172.19.13.125	Log on	Administrator	Administrator [admin] logged on from [172.19.13.125].
2015/10/13 15:52:44	admin	172.19.13.125	Log on	Administrator	Administrator [admin] logged on from [172.19.13.125].
2015/10/13 15:52:23	admin	172.19.13.125	Log on	Administrator	Administrator [admin] logged on from [172.19.13.125].
2015/10/13 15:52:23	admin	172.19.13.125	Log on	Administrator	Administrator [admin] logged on from [172.19.13.125].
2015/10/13 15:51:23	admin	172.19.13.125	Update	Access Point	AP [RuckusAP@6C-AA-B3:12:49:80] configuration updated.
2015/10/13 15:51:22	admin	172.19.13.125	Update	WLAN	WLAN [devit-wlan-qd7n4DMC] of zone [devit-zone-m3YJurVO] updated.
2015/10/13 15:51:22	admin	172.19.13.125	Update	WLAN	WLAN [devit-wlan-qd7n4DMC] of zone [devit-zone-m3YJurVO] updated.
2015/10/13 15:51:22	admin	172.19.13.125	Create	WLAN	WLAN [devit-wlan-qd7n4DMC] of zone [devit-zone-m3YJurVO] created.
2015/10/13 15:51:22	admin	172.19.13.125	Log on	Administrator	Administrator [admin] logged on from [172.19.13.125].
2015/10/13 15:51:22	admin	172.19.13.125	Log on	Administrator	Administrator [admin] logged on from [172.19.13.125].
2015/10/13 15:50:20	admin	172.19.13.125	Update	Access Point	AP [RuckusAP@6C-AA-B3:12:49:80] configuration updated.
2015/10/13 15:50:19	admin	172.19.13.125	Log on	Administrator	Administrator [admin] logged on from [172.19.13.125].
2015/10/13 15:50:19	admin	172.19.13.125	Log on	Administrator	Administrator [admin] logged on from [172.19.13.125].
2015/10/13 15:49:05	admin	172.19.13.125	Log on	Administrator	Administrator [admin] logged on from [172.19.13.125].

Figure 176: Define the filters that you want to use to search for administrator actions

### Exporting the Administrator Activity List to CSV

Follow these steps to export the administrator activity list to a CSV file.

1. Go to **Monitor > Administrator Activity**.
2. Click the **Export CSV** button in the content area.

The following message appears: `Downloading Administrator Data. Please wait...`

3. When the message disappears, check the default download folder for your web browser and look for a file named `auditLog.csv`.
4. Use a spreadsheet application (for example, Microsoft Excel®) to view the contents of the CSV file.

You have completed exporting the administrator activity list to CSV.

**Ruckus** 2015/10/14 08:36:49

Dashboard Monitor Configuration Report Identity

Monitor >> Administrator Activity

### Administrator Activity List

View a list of all administrator activities saved on the controller. To filter the activity list, click **Load Criteria**, and then configure the filters that you want to apply.

Refresh **Export CSV**

▲ Load Criteria:

+  
Load Data Reset All

Date and Time ▼	Administrator	Source IP	Action	Resource	Description
2015/10/13 15:53:48	admin	172.19.13.125	Delete	AP Zone	Zone [devit-zone-m3YJuxVO] deleted.
2015/10/13 15:53:48	admin	172.19.13.125	Log on	Administrator	Administrator [admin] logged on from [172.19.13.125].
2015/10/13 15:53:47	admin	172.19.13.125	Log on	Administrator	Administrator [admin] logged on from [172.19.13.125].
2015/10/13 15:52:46	admin	172.19.13.125	Update	Access Point	AP [RuckusAP@6C:AA:B3:12:49:80] configuration updated.
2015/10/13 15:52:46	admin	172.19.13.125	Log on	Administrator	Administrator [admin] logged on from [172.19.13.125].
2015/10/13 15:52:46	admin	172.19.13.125	Log on	Administrator	Administrator [admin] logged on from [172.19.13.125].
2015/10/13 15:52:44	admin	172.19.13.125	Log on	Administrator	Administrator [admin] logged on from [172.19.13.125].
2015/10/13 15:52:44	admin	172.19.13.125	Log on	Administrator	Administrator [admin] logged on from [172.19.13.125].
2015/10/13 15:52:23	admin	172.19.13.125	Log on	Administrator	Administrator [admin] logged on from [172.19.13.125].
2015/10/13 15:52:23	admin	172.19.13.125	Log on	Administrator	Administrator [admin] logged on from [172.19.13.125].
2015/10/13 15:51:23	admin	172.19.13.125	Update	Access Point	AP [RuckusAP@6C:AA:B3:12:49:80] configuration updated.
2015/10/13 15:51:22	admin	172.19.13.125	Update	WLAN	WLAN [devit-wlan-qd7n4DMC] of zone [devit-zone-m3YJuxVO] up

Figure 177: Click the Export CSV button to download a CSV file that contains details of administrator activity

# Working with Reports

In this chapter:

- [Types of Reports](#)
- [Creating a New Report](#)
- [Viewing a List of Existing Reports](#)
- [Deleting a Report](#)

## Types of Reports

The controller provides the following types of reports:

**NOTE:** If you download a CSV report created by SCG, the file naming convention is as follows:

<report title>-YYYY-MM-DD\_HH-MM-SS-MS\_ZZ

where

MS stands for three-digit milliseconds.

ZZ is a random number to avoid the file name conflict when a user subscribes to several reports but based on the same filter. ZZ ranges between 00-99.

For example: New\_Client-2015-11-17\_08-00-16-031\_59.csv

### Active TTG Sessions Report

The **Active TTG Sessions** report shows a historical view of the number of active TTG sessions established in the controller.

The active TTG session report can be shown in different time intervals for a specified duration. The report can be generated based on specific control planes or GGSN IP addresses.

### Client Number Report

This **Client Number Report** shows a historical view of the maximum and minimum number of clients connect to the system.

Client number can be shown in different time intervals for a specified duration. The report can be generated based on specific management domain, AP zone, AP, SSID, or radio type.

### Client Number vs Airtime Report

This **Client Number vs Airtime Report** shows a historical view of the average number of clients connected to the system and the corresponding airtime (TX, RX, Busy).

Client number and airtime can be shown in different time intervals for a specified duration. The report can be generated based on a specific management domain, AP zone, AP, SSID, or radio type.

## Continuously Disconnected APs Report

The **Continuously Disconnected APs Report** shows the list of access points disconnected with specified time range.

The report can be generated based on specific management domain and AP zone.

## Failed Client Associations Report

The **Failed Client Associations Report** shows a historical view of the number of failed client associations.

Failed client associations can be shown in different time intervals for a specified duration. The report can be generated based on specific management domain, AP zone, AP, SSID, or radio type.

## New Client Associations Report

The **New Client Associations Report** shows a historical view of the number of new client associations.

New client Associations can be shown in different time intervals for a specified duration. The report can be generated based on specific management domain, AP zone, AP, SSID, or radio type.

## System Resource Utilization Report

The **System Resource Utilization Report** shows a historical view of the CPU and memory usage of the system.

The CPU and memory usage can be shown in different time intervals for a specific duration. The report can be generated based on specific blade.

## TX/RX Bytes Report

This **TX/RX Bytes Report** shows a historical view of the transmitted (TX) and received (RX) bytes of the system.

The transmitted and received bytes can be shown in different time intervals for a specified duration. The report can be generated based on a specific management domain, AP zone, AP, SSID or radio type.

## Creating a New Report

1. On the **Saved Reports List** page, click **Create New**.

The **Create New Report** form appears.

2. Perform the following steps to create a new report:

[Step 1: Define the General Report Details](#) on page 317

[Step 2: Define the Resource Filter Criteria](#) on page 317

[Step 3: Define the Time Filter](#) on page 318

[Step 4: Define the Report Generation Schedule](#) on page 319

[Step 5: Enable Email Notifications \(Optional\)](#) on page 319

[Step 7: Save the Report](#) on page 320

## Step 1: Define the General Report Details

Defining report details is the first step to creating a new report. You would also need to define the resource filter, time filter, generation schedule and enable email notifications.

Follow these steps to define the general details of the report that you are creating in the **General Information** section.

1. In **Title**, type a name for the report that you are creating.
2. In **Description**, type a brief description for the report.
3. In **Report Type**, select the type of report that you want to create.

For detailed description of the various report types, refer to [Types of Reports](#) on page 315.

4. In **Output Format**, select one or both of the following check boxes:
  - **CSV**: A comma-separated version of the report. You will need a spreadsheet application (for example, Microsoft Excel®) to view the report in CSV format.
  - **PDF**: A portable document format version of the report. You will need a PDF reader (for example, Adobe Acrobat®) to view the report in PDF.

Continue to [Step 2: Define the Resource Filter Criteria](#) on page 317.

## Step 2: Define the Resource Filter Criteria


Defining resource filter is the second step to creating a new report. You would also need to define the time filter, generation schedule, enable email notifications.

Follow these steps to define the resources upon which the report that you are creating will be generated. These resources can be defined in the **Resource Filter Criteria** section..


Select the resources upon which to generate the report. Resources include:


Option	Description
--------	-------------

<b>Device</b>	Select one of the following device resources:
---------------	-----------------------------------------------

**Management Domain:** If you base the report upon this device resource, you must select at least one management domain from the drop-down list. If you want to include multiple management domains in the report, select the management domains from the drop-down list one at a time. To delete a management domain that you selected previously, click the  icon next to the management domain name.

**AP Zone:** If you base the report upon this device resource, you must select at least one AP zone from the drop-down list. If you want to include multiple AP zones in the report, select the AP zones from the drop-down list one at a time.

To delete an AP zone that you selected previously, click the  icon next to the management domain name.

Option	Description
	<b>Access Point:</b> If you base the report upon this device resource, you must select the name of the specific access point from the drop-down list. You can only select one access point to include in the report.
<b>SSID</b>	Select the SSID or SSIDs that you want to include in the report. If you want to include multiple SSIDs in the report, select the SSIDs from the drop-down list one at a time. To delete an SSID that you selected previously, click the  icon next to the SSID.  If you do not select an SSID, all existing SSIDs that belong to the device resource you selected in Device will be included in the report.
<b>Radio</b>	Select the radio (2.4G or 5G) that you want to include in the report. If you do not select a radio, both 2.4G and 5G radios belong to the device resource you selected in Device will be included in the report.  <b>NOTE:</b> You must select at least one resource. You can also select and define all three available resources.

Continue to [Step 3: Define the Time Filter](#) on page 318.

### Step 3: Define the Time Filter

Follow these steps to define the time filter to use in generating the report.

The time filter can be defined in the **Time Filter** section.

1. In **Time Interval**, select the interval at which to generate the report. Available time interval options include:
  - **15 Minutes**
  - **Hourly**
  - **Daily**
  - **Monthly**
2. In **Time Filter**, select the time or date period for which to generate the report. Depending on the time interval that you set above, available periods include:
  - **Hours**
  - **Days**
  - **Months**

**NOTE:** The controller uses this time interval-time filter combination to determine the period from which to generate the report and how often to generate it.

Continue to [Step 4: Define the Report Generation Schedule](#) on page 319.

## Step 4: Define the Report Generation Schedule

Follow these steps to define the report generation schedule. This schedule can be defined in the **Schedules** section.

1. In the **Schedules** section, click **Add New**.
2. In **Interval**, select one of the following time intervals:
  - **Monthly**: If you select this interval, select the day of the month in **Every** when the controller will generate the report.
  - **Weekly**: If you select this interval, select the day of the week in **Every** when the controller will generate the report.
  - **Daily**
  - **Hourly**
3. In **@Hour** (except **Hourly** when interval is selected above), select the hour of the day when the controller will generate the report.  
The controller uses the 24-hour clock format.
4. In **Minute**, select the minute of the hour when the controller will generate the report.  
This minute setting will be used in conjunction with the hour setting that you selected above (except when **Hourly** interval is selected).
5. If you want to add more schedules, click the **Add New** button again, and then repeat steps 2-4.  
You can create as many schedules as required. Schedules may overlap if needed.

Continue to [Step 5: Enable Email Notifications \(Optional\)](#) on page 319.

## Step 5: Enable Email Notifications (Optional)

Follow these steps to enable the controller to send email notifications when a report has been generated.

**NOTE:** Make sure you configure the SMTP settings (see [Configuring the System Settings](#) on page 203). If the SMTP settings are not configured, the controller will be unable to send out email notifications even if you enable this feature in this section.

1. In the **Email Notification** section, click the **Enable** button.
2. In the text box below, type the email address to which to send the notification.
3. To add another email address, click **Add New**, and then type the second email address in the text box that appears.

**NOTE:** You can add as many email addresses as needed by clicking the **Add New** button, and then typing an additional email address. Note, though, that you must only type a single email address in each text box.

Continue to [Step 6: Export the Report to an FTP Server \(Optional\)](#) on page 320.

## Step 6: Export the Report to an FTP Server (Optional)

Follow these steps to automatically export a copy of the report to an FTP server whenever it is generated.

1. In **Export Report Results**, click **Enable**.
2. In **FTP Server**, select the FTP server to which you want to automatically export the reports. The FTP server options that appear here are those that you created in [Configuring FTP Services](#) on page 165.

Continue to [Step 7: Save the Report](#) on page 320

## Step 7: Save the Report

After you complete steps 1 through 5, review the settings that you have configured to make sure they are correct.

To save the report, click **OK** at the bottom of the page.

The page refreshes, and the report that you created appears in the **Saved Report List** page.

You have completed creating a report.

## Viewing a List of Existing Reports


View a list of configured reports.

Follow these steps to view a list of reports that have been configured.

1. Go to **Report > Saved Reports**.

The **Saved Report List** page appears, displaying a summary of all reports that have been configured. Summary details include:

- Title
- Description
- Report Template
- Time Filter
- Resource Filter
- Schedule
- Status
- Actions that you can perform

2. To view a report, click the  icon that is in the same row as the report name.

The **Report Result** page appears, displaying versions of the report that have been generated based on the time interval defined in the report schedule. To download and view a comma-separated value (CSV) version of the report, click the **CSV** link that is in the same row as the version that you want to view.



## Deleting a Report

Follow these steps to delete an existing report.

1. Go to **Report** > **Saved Reports**.

The **Saved Report List** page appears, displaying a summary of all reports that have been configured.

2. From the list of reports, locate the report that you want to delete.

3. Once you locate the report, click the  icon that is under the **Actions** column.

A confirmation message appears.

4. Click **OK**.

The list of reports refreshes, and then the report that you deleted disappears from the list.

You have completed deleting a report.

# Working with Local, Guest, and Remote Users

# 15

In this chapter:

- [Working with Local, Guest, and Remote Users](#)
- [Working with User Roles](#)
- [Managing Subscription Packages](#)

In this chapter:

## Working with Local, Guest, and Remote Users

The controller supports the following types of user accounts:

### Working with Local Users

A local user in the controller refers to a registered user who may be given access to the controller hotspot.

A user account contains a user's personal information, logon information, and the subscription package that he or she has been assigned.

This section describes the following tasks:

#### Creating a Local User Account

Follow these steps to create a user account.

**NOTE:** When you create a user account, you will be required to assign a subscription package to the user. Before creating a user account, Ruckus Wireless® recommends creating at least one subscription package. See [Creating a Subscription Package](#) for more information.

1. Go to **Configuration > Identity > Users**.
2. Click **Create New**.
3. In the **Contact Details** section, fill out the following boxes:
  - **First Name**
  - **Last Name**
  - **Email**
  - **Phone**
  - **Country**
  - **City**
  - **Street**
  - **Zip Code**
  - **State:** Select **Enabled** to enable this user profile or select **Disabled**.
  - **Remark**

4. In the **Login Details** section, fill out the following boxes to create the logon credentials of this user:
  - **User Name:** Type a name for this user. The user name is not case-sensitive and will always be displayed in lowercase characters.
  - **Password:** Type a password for this user. The password must be at least eight characters in length.
  - **Confirm Password:** Retype the password above.
5. In the **Subscription Details** section, select a subscription package that you want to assign to this user (see [Managing Subscription Packages](#) on page 337).
6. Click **OK**.

You have completed creating a user account.

**Create New User**

Contact Details	Login Details
First Name: * John	User Name: *
Last Name: * Doe	Password: *
Email: john.doe@ruckuswireless.com	Confirm Password: *
Phone: 1234567	<b>Subscription Details</b>
Address:	Subscription Package: * Local User Package
City:	Expiration: Never Expires
State:	Description:
Zip Code:	
Country: UNITED STATES	
Remark:	

OK Cancel

**Figure 178: Creating a user account**

### Editing a Local User Account

Follow these steps to edit an existing local user account.

1. Go to **Configuration > Identity > Users**.
2. Locate the user account that you want to edit, and then click the user name.

The **Edit User: {{User Name}}** form appears.
3. Edit the user account by updating the fields in the **Contact Details** and **Login Details** sections.
4. Click **OK**.

Contact Details		Logon Details	
First Name:	* XYZ	User Name:	* xyz
Last Name:	* User	Password:	* .....
Email:		Confirm Password:	* .....
Phone:		<b>Subscription Details</b>	
Address:		Subscription Package:	Local User Package
City:		Expiration:	Never Expires
State:		Status:	Available
Zip Code:		<b>Subscription Renewal</b>	
Country:	UNITED STATES		
Is Disabled:	* No		
Remark:			

Apply Cancel

Figure 179: Editing a user account

## Working with Guest Users

Similar to local user accounts, guest user accounts in the controller allow users to gain access to the controller hotspots.

However, unlike local user accounts, guest users are not required to provide personal information to access the controller hotspots and can, therefore, remain anonymous.

(See [Working with Local Users](#) on page 322.)

### Generating Guest Passes

Guest users require guest passes, which are credentials that allow temporary access to the controller hotspots and are generated for specific WLANs only – guest pass users will only be able to gain access to the WLANs for which the guest pass was generated.

Generating guest passes involves the following steps:

[Step 1: Create a Guest Access Portal](#) on page 324

[Step 2: Create a Guest Access WLAN](#) on page 326

[Step 3: Generate a Guest Pass](#) on page 326

**NOTE:** If you want to send the guest pass to guest users via Short Message Service (SMS), make sure you add the SMS server to the controller before starting the next procedure. For information on adding an SMS server to the controller, see [Configuring an SMS Server](#) on page 170.

### Step 1: Create a Guest Access Portal

Each guest WLAN must be associated with a guest access portal, which defines the behavior of the guest WLAN interface.

Follow these steps to create a guest access portal.

1. Create an AP zone that you want to use to provide hotspot access to guest users. For more information, see [Creating an AP Zone](#) on page 32.

2. After you have created an AP zone, go to **Configuration > AP Zones**.
3. On the **AP Zone List** page, click the name of the AP zone that you have created to go to its configuration page.

The configuration page for that AP zone appears.

4. On the sidebar, click **Guest Access**.

The **Guest Access** page appears.

5. Click **Create New**.

The **Create New Guest Access Portal** form appears.

6. In **General Options**, configure the following:

- **Portal Name**
- **Portal Description**
- **Language**

7. In **Start Page** under **Redirection**, set where users will be redirected after they log in successfully:

- **Redirect to the URL that user intends to visit:** You could redirect users to the page that they want to visit.
- **Redirect to the following URL:** You could set a different page where users will be redirected (for example, your company website).

8. In **Guest Access**, configure the following:

- a) **Guest Pass SMS Gateway:** If you want to send the guest pass to users using SMS and you configured an SMS server earlier, select the SMS server. Otherwise, select **Disabled**.
- b) **Terms and Conditions:** To require users to read and accept your terms and conditions prior to use, **Show Terms And Conditions** check box.

The box below, which contains the default **Terms of Use** text, becomes editable. Edit the text or leave it unchanged to use the default text.

- c) **Web Portal Logo:** By default, the guest hotspot logon page displays the Ruckus Wireless® logo.

To use your own logo, click the **Upload** button, select your logo (recommended size is 138 x 40 pixels, maximum file size is 20KB), and then click **Upload**.

- d) **Web Portal Title:** Type your own guest hotspot welcome text or accept the default welcome text (Welcome to the Guest Access login page).

9. In **User Session**, configure the following:

- a) **Session Timeout:** Specify a time limit after which users will be disconnected and required to log on again.
- b) **Grace Period:** Set the time period during which clients will not need to re-authenticate after getting disconnected from the hotspot.

Enter a number (in minutes) between 1 and 14399.

10. Click **OK**.

**Create New Guest Access Portal**

**General Options**

Portal Name: \*

Portal Description:

Language: \* English

**Redirection**

**Guest Access**

Guest Pass SMS Gateway: \* Disabled

Terms and Conditions:  Show Terms and Conditions

Terms of Use

By accepting this agreement and accessing the wireless network, you acknowledge that you are of legal age, you have read and understood, and agree to be bound by this agreement.  
(\* ) The wireless network service is provided by the property owners and is completely at their discretion. Your access to the network may be blocked, suspended, or terminated at any time for any reason.  
(\* ) You agree not to use the wireless network for any purpose that is unlawful or otherwise prohibited and you are fully responsible for your use.  
(\* ) The wireless network is provided "as is" without warranties of any kind, either expressed or implied.

**Web Portal Logo:** Upload your logo to display it on the web portal pages. The recommended image size is 138 x 40 pixels and the maximum file size is 20KB. Select an image file to **Upload**

**Web Portal Title:** Welcome to the Guest Access login page.

**User Session**

Session Timeout: \* 1440 Minutes (2-14400)

Grace Period: \* 60 Minutes (1-14399)

**OK Cancel**

**Figure 180: The Create New Guest Access Portal form**

You have completed creating a guest access portal. You may now continue to [Step 2: Create a Guest Access WLAN](#) on page 326.

**Step 2: Create a Guest Access WLAN**

In this step, you will create a WLAN for the AP zone that you created in [Step 1: Create a Guest Access Portal](#) on page 324.

1. Create a new WLAN by following the instructions in [Creating a WLAN](#) on page 68.
2. Make sure though that you configure **Authentication Type** and **Hotspot (WISPr) Service** exactly as described below.
  - In **Authentication Type**, click **Guest Access**.
  - In **Guest Access**, select the guest access portal that you created earlier in [Step 1: Create a Guest Access Portal](#) on page 324.
3. Click **Create New**.

You have completed creating a guest access WLAN. Continue to [Step 3: Generate a Guest Pass](#) on page 326.

**Step 3: Generate a Guest Pass**

Follow these steps to generate a guest pass.

1. Click **Identity > Users**.  
The **Users** page appears.
2. Click **Guest Pass > Guest Pass Service**.

The **Guest Pass** page appears.

3. Click **Generate Guest Pass**, and then click **Next**.

4. Configure the following options:

- a) **Guest Name:** Type a name that you want to assign to the guest user.
- b) **Guest WLAN:** Select the guest WLAN that you created in [Step 2: Create a Guest Access WLAN](#).
- c) **Number of Passes:** Type the number of guest passes that you want to generate.
- d) **Pass Valid For:** Set the validity period for the guest pass by filling in the two boxes.

For example, if you want the guest pass to be valid for seven days, type 7 in the first box, and then select **Days** in the second box.

5. Configure the advanced options:

- a) **Pass Generation:** Select the **Auto Generate** check box if you want the controller to generate the guest pass key automatically. If you want to generate the guest pass manually, clear the **Auto Generate** check box.

**NOTE:** If you are generating more than one guest pass, the **Auto Generate** check box is selected automatically and is not configurable.

- b) **Pass Effective Since:** Set the guest pass validity period by selecting one of the following options:

- **Effective from the creation time:** This type of guest pass is valid from the time it is first created to the specified expiration time, even if it is not being used by any end user.
- **Effective from first use:** This type of guest pass is valid from the time the user uses it to authenticate with controller until the specified expiration time. An additional parameter (A Guest Pass will expire in X days) can be configured to specify when an unused guest pass will expire regardless of use. The default is 7 days.
- **Expire guest pass if not used within [ ] days:** If you want this guest pass to expire if it is unused after you generated it, type the number of days in the box (maximum value is 365 days).

- c) **Max Devices Allowed:** Set the number of users that can share this guest pass.

- **Limited to [ ]:** If you want a limited number of users to share this guest pass, click this option, and then type the number in the box.
- **Unlimited:** If you want an unlimited number of users to share this guest pass, click this option.
- **Session Duration:** If you clicked **Unlimited**, this option appears. If you want require users to log on again after their sessions expire, select the **Require guest re-login after [ ]** check box, and then select a time increment. If this feature is disabled, connected users will not be required to re-log in until the guest pass expires.

- d) In **Remarks** (optional), type your notes about this guest pass, if any.

6. Click **Generate**.

The page refreshes, and then the guest pass you generated appears in a table, along with other guest passes that exist on the controller.

7. Click **OK** to close the pop-up message.

**Figure 181: Generating a guest pass**

You have completed generating a guest pass. You are now ready to send the guest pass to guest users. See [Step 4: Send Guest Passes to Guest Users](#) on page 328 for information.

#### Step 4: Send Guest Passes to Guest Users

On the page that appears after you generate a guest pass are options for delivering the guest pass to guest users.

(See [Figure 182: Options for delivering guest passes to guest users](#) on page 328).

These delivery options include:

Here are the generated guest passes

Refresh Print Selected Export CSV Email SMS Delete Selected

▲ Load Criteria:

+  
Load Data Reset All

<input checked="" type="checkbox"/>	Guest Name	Key	Remarks	Generated	Expiration Date	WLAN	Actions
<input checked="" type="checkbox"/>	ABC	BwSjfkem		2015/10/15 11:35:53	2015/10/16 11:35:53	[GuestWLAN] of [SCG34-shy...	

**Figure 182: Options for delivering guest passes to guest users**



### **Printing the Guest Pass**

After you generate the guest pass, you can print the guest pass information, which contains the guest user information and instructions on how to connect to the hotspot, and give it to the guest user.

**NOTE:** If your browser is blocking pop-ups, make you temporarily disable the pop-up blocker so you can view and print the guest pass.

Follow these steps to print a guest pass.

1. Select the guest passes that you want to print by selecting the check boxes before them.
2. In **Guest Instruction HTML Template**, select a printout template to use.

The default printout template (`default.html`) is selected by default. If you created custom printout templates (see [Creating a Guest Pass Printout Template](#) on page 335), they will appear in the drop-down menu.

3. Click **Print Selected**.

A new browser page appears, which displays the guest pass and available printing options.

4. Configure your printer settings, and then print the guest passes.

You have completed printing the guest passes.

### **Connecting as a Guest to the Corporate Wireless Network**

Greetings, **ABC**

You have been granted access to the company wireless network, which you can use to access both the World Wide Web and Internet, and to check your personal email.

Your guest pass key is: **BwSjfkem**

This guest pass is valid until **2015/10/16 11:35**

Connect your wireless-ready PC to the following network(s): **GuestWLAN**, as detailed in the instructions printed below.

Before you start, please review the following requirements.

#### **Requirements**

- A wireless-network-ready computer
- The corporate "guest" network name
- The guest pass (a text "key")

**Figure 183: What a guest pass printout looks like**

### **Exporting the Guest Pass to CSV**

Follow these steps to export the last generated guest passes to a comma-separated value (CSV) file.

1. Select the guest passes that you want to export to CSV by selecting the check boxes before them.
2. Click **Export CSV**.

Your web browser downloads the CSV file to its default download location.

3. Go to your web browser's default download location and look for a file named `guestpass[number].csv`.
4. Using Microsoft Excel® or a similar application, open the CSV file.

The CSV file displays the details of the guest passes, including:

- Guest Name
- Remarks
- Key
- Expiration Date

You have completed exporting the last generated guest passes to CSV.

	A	B	C	D	E
1	#Guest Name (M	Remarks	Key (Empty implies random key)		
2	Batch-Guest-1	Batch generation	AAAAAAAA		
3	Batch-Guest-2	Batch generation	bbbbbbb		
4	Batch-Guest-3	Batch generation	CCCCCCC		
5					
6					

**Figure 184: A sample CSV of generated guest passes when opened in Excel®**

### ***Sending the Guest Pass via Email***

You can email the guest passes you generate to guest users.

**NOTE:** To send guest passes via email, you must have added an external email server to the controller. For more information, see [Configuring the SMTP Server Settings](#) on page 207.

1. Select the guest passes that you want to send via email by selecting the check boxes before them.
2. Click **Email**.

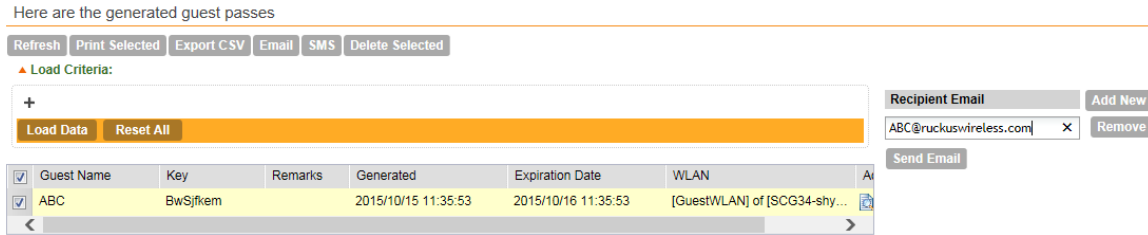
The **Recipient Email** form appears on the right side of the page (see [Figure 185: Use the Recipient Email form to specify who will receive the guest passes via email](#) on page 331).

3. Click **Add New**.
4. In the box that appears below, type the email address to which you want to send the guest passes.
5. To add another recipient, click **Add New** again, and then type another email address.
6. When you have finished adding all the email recipients, click **Send Email**.

A dialog box appears and informs you that the emails have been sent to the message queue successfully

7. Click **OK** to close the dialog box.

You have completed sending guest passes via email.



**Figure 185:** Use the Recipient Email form to specify who will receive the guest passes via email

### ***Sending the Guest Pass via SMS***

Follow these steps to send the guest pass via SMS.

**NOTE:** To send guest passes via email, you must have added an external SMS gateway to the controller. For more information, see [Configuring an SMS Server](#) on page 170.

1. Select the guest passes that you want to send via SMS by selecting the check boxes before them.
2. Click **SMS**.

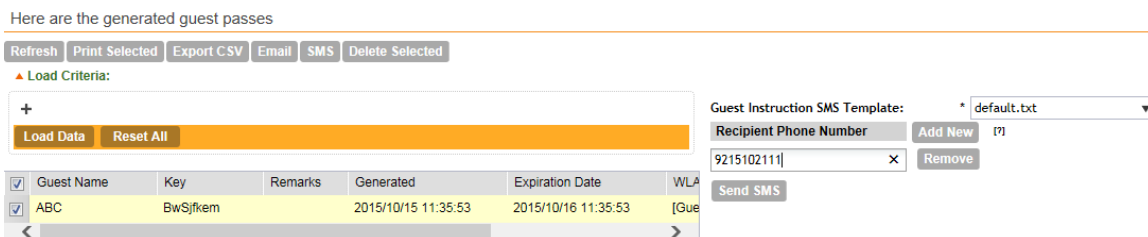
SMS options appears on the right side of the page (see [Figure 186: Options for sending guest passes via SMS](#) on page 331).

3. In **Guest Instruction SMS Template**, select the SMS template that you want to use.
4. Click **Add New**.
5. In the box that appears below, type the phone number to which you want to send the guest passes via SMS.
6. To add another SMS recipient, click **Add New** again, and then type another phone number.
7. When you have finished adding all the SMS recipients, click **Send SMS**.

A dialog box appears and informs you that the SMS messages have been sent to the message queue successfully

8. Click **OK** to close the dialog box.

You have completed sending guest passes via SMS.



**Figure 186:** Options for sending guest passes via SMS

### Generating Guest Passes from an Imported CSV

You can also manually define the guest passes that you want to generate in a comma-separated value (CSV) file (a sample of which is available for download from the **Guest Pass** page).

Follow these steps to generate guest passes from an imported CSV file.

1. Click **Configuration > Identity > Users**.
2. Click **Guest Pass > Guest Pass Service**.

The **Guest Pass** page appears.

3. Click **Import Guest Pass**, and then click **Next**.
4. Look for the following text under **Browse**:

To download a sample guest pass, click here.

5. Click the **here** link to download the sample CSV file.
6. Using Microsoft Excel<sup>®</sup> or a similar application, open the CSV file.
7. In the CSV file, fill out the following columns:

- **#Guest Name (Must)**: Assign a user name to the guest pass user.
- **Remarks (Optional)**: Add some notes or comments about this guest pass.
- **Key**: Enter a guest pass key or leave it blank so the controller can generate the key automatically.

	A	B	C	D	E
1	#Guest Name (M	Remarks	Key (Empty implies random key)		
2	Batch-Guest-1	Batch generation	AAAAAAA		
3	Batch-Guest-2	Batch generation	bbbbbbb		
4	Batch-Guest-3	Batch generation	ccccccc		
5					
6					

Figure 187: The sample CSV file when opened in Excel<sup>®</sup>

8. Save the CSV file.
9. Go back to the **Guest Pass** page, and then configure the following settings on the **Common Guest Pass Settings**:
  - a) **Guest WLAN**: Select the guest WLAN that you created in [Step 2: Create a Guest Access WLAN](#) on page 326.
  - b) **Pass Valid For**: Set the validity period for the guest pass by filling in the two boxes. For example, if you want the guest pass to be valid for seven days, type 7 in the first box, and then select Days in the second box.
10. Configure the advanced options:
  - a) **Pass Effective Since**: Set the guest pass validity period by selecting one of the following options:
    - **Effective from the creation time**: This type of guest pass is valid from the time it is first created to the specified expiration time, even if it is not being used by any end user.

- **Effective from first use:** This type of guest pass is valid from the time the user uses it to authenticate with the controller until the specified expiration time. An additional parameter (A Guest Pass will expire in X days) can be configured to specify when an unused guest pass will expire regardless of use. The default is 7 days.
- **Expire guest pass if not used within [ ] days:** If you want this guest pass to expire if it is unused after you generated it, type the number of days in the box (maximum value is 365 days).

b) **Max Devices Allowed:** Set the number of users that can share this guest pass.

- **Limited to [ ]:** If you want a limited number of users to share this guest pass, click this option, and then type the number in the box.
- **Unlimited:** If you want an unlimited number of users to share this guest pass, click this option.
- **Session Duration:** If you clicked Unlimited, this option appears. If you want require users to log on again after their sessions expire, select the **Require guest re-login after [ ]** check box, and then select a time increment. If this feature is disabled, connected users will not be required to re-log in until the guest pass expires.

11. In **Guest List CSV File** (at the top of the page), click **Browse**, and then select the CSV file you edited earlier.

The page refreshes, and the number of guest passes that the controller has identified in the CSV file appears below the **Browse** button.

12 Click **Generate**.

The page refreshes, and then the guest pass you generated appears in a table, along with other guest passes that exist on the controller.

**Import Guest Pass**

Guest List CSV File:

3 guest passes have been identified.  
To download a sample guest pass, click [here](#)

**Common Guest Pass Settings**

Guest WLAN: \*  ▼

Pass Valid For: \*   ▼

**Advanced Options**

Pass Effective Since:  Effective from the creation time  
 Effective from first use

Expire new guest pass if not used within:  days

Max Devices Allowed: \*  Limited to   
 Unlimited

**Figure 188: The Guest Pass page for importing a CSV file**

You have completed generating a guest pass. You are now ready to send the guest pass to guest users. See [Step 4: Send Guest Passes to Guest Users](#) on page 328 for information.

### Viewing the List of Guest Users

Follow these steps to view guest users that currently exist on the controller.

1. Click **Configuration > Identity > Users**.
2. Click the **User Type** column to sort all existing user accounts by user type.

All users of the user type "Guest" are guest users.

You have completed view the list of guest users.

### Deleting Guest Users

Follow these steps to delete guest users.

1. Click **Configuration > Identity > Users**.
2. Select the check boxes before the guest user accounts that you want to delete.
3. Click **Delete Selected**.

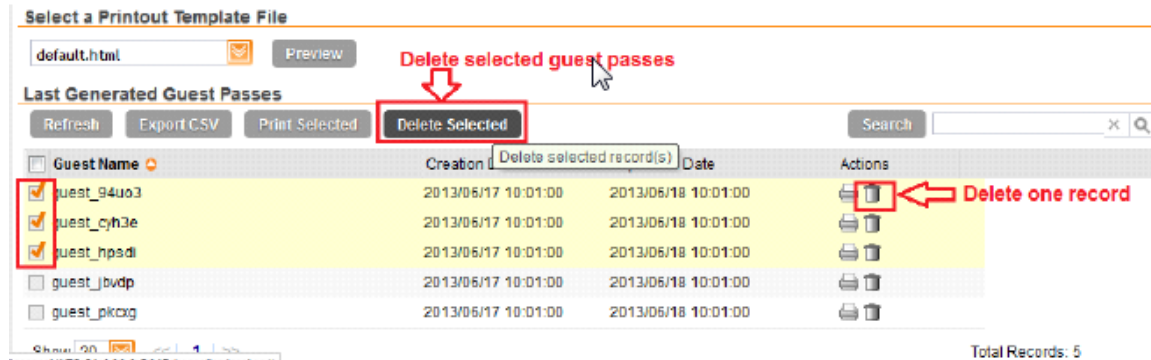
A confirmation message appears.

4. Click **Yes** to confirm.

The page refreshes, and the guest user accounts that you deleted disappears from the list.

**NOTE:** To delete a single guest pass, click the  (delete) icon that is in the same row as the guest pass name.

You have completed deleting a guest pass or guest passes.



**Figure 189: Deleting a single guest pass or multiple guest passes**

### Creating a Guest Pass Printout Template

A guest pass printout template contains variables for the information that guest users need to connect to the controller hotspots (for example, guest name, key, and WLAN name), as well as the actual instructions for connecting to the WLAN.

A default printout template exists in the controller. If you want to create your own printout template, follow these steps.

1. Go to **Configuration > Identity > Users**.
2. Click **Guest Pass > Manage Templates**.

The **Manage Guest Instruction Templates** page appears.

3. Using an HTML editor, create a new HTML or text file.
4. Add content to the file.

Typically, a printout template contains instructions for connecting to the controller hotspot. See [Figure 187](#) for the content of the default printout template.

## Connecting as a Guest to the Corporate Wireless Network

Greetings, **{GP\_GUEST\_NAME}**

You have been granted access to the company wireless network, which you can use to access both the World Wide Web and Internet, and to check your personal email.

Your guest pass key is: **{GP\_GUEST\_KEY}**

This guest pass is valid until **{GP\_VALID\_TIME}**

Connect your wireless-ready PC to the following network(s): **{GP\_GUEST\_WLAN}**, as detailed in the instructions printed below.

Before you start, please review the following requirements.

**Figure 190: Content of the default printout template**

5. Insert the following variables into the content of your template:
  - `{GP_GUEST_NAME}`: This is the guest pass user name.
  - `{GP_GUEST_KEY}`: This is the guest pass key.
  - `{GP_VALID_TIME}`: This is the expiration date and time of the guest pass.
  - `{GP_GUEST_WLAN}`: This is the WLAN with which the guest user can associate using the guest name and guest key.

6. Save the file.

7. On the **Manage Guest Instruction Templates** page, click the appropriate **Upload** button for the template that you are creating.

The **Upload a Template File** form appears on the right side of the page.

8. Configure the **Upload a Template File** options:

- a) **Template Name**: Type a name for the template that you are uploading.
- b) **Template File**: Click **Browse**, and then select the template file you created.

9. Click **Upload**.

An information message box appears and informs you that the template file has been uploaded successfully.

10. Click **OK**.

The template file you uploaded now appears on the list of templates.

### Guest Pass Templates

View existing guest templates and basic information about them. To view detailed information about a specific guest template, click the guest template name.  
Guest Instruction HTML Templates

The screenshot shows a web interface for managing guest pass templates. On the left, there is a table with columns for 'Name' and a list of existing templates, including 'default.html'. Above the table are buttons for 'Refresh', 'Upload', and 'Delete Selected'. On the right, there is a form titled 'Upload a Template File' with two required fields: 'Template Name' and 'Template File'. The 'Template File' field has a 'Browse' button next to it. Below the form are 'Upload' and 'Cancel' buttons.

**Figure 191: The Upload a Template File form**



## Working with User Roles

Use user roles to limit user access to certain WLANs, to allow them to log on with non-standard client devices, or to grant permission to generate guest passes.

### Creating a User Role

A user role limits user access to certain WLANs and allows them to log on with non-standard client devices, or grants permission to generate guest passes.

Follow these steps to create a user role.

1. Go to **Identity > Roles**.
2. Click **Create New**.

The **Create User Role** form appears.

3. **Role Name:** Type a name for this user role.
4. **Description:** Type a description for this user role.
5. **User Traffic Profile:** Select the user traffic profile form the drop-down menu.

**NOTE:** Users can set a group attribute from the RADIUS server/Active Directory/LDAP.

6. Click **OK**.

You have completed creating a user role.

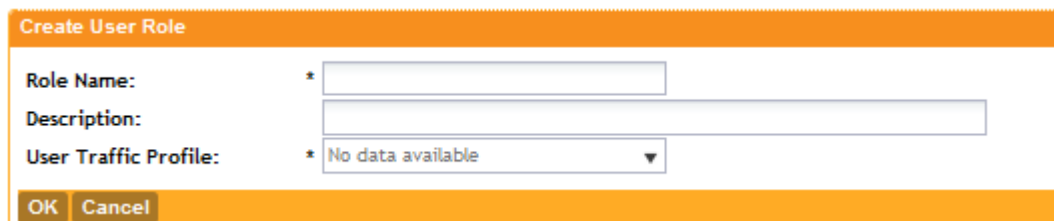


Figure 192: Creating a user role

## Managing Subscription Packages

A subscription package defines the characteristics of a subscription that has been created for a registered user.

See [Working with Local Users](#) on page 322. These characteristics include the expiration date of the subscription.

**NOTE:** If the user is connected at the time when his or her subscription expires, the user will get disconnected from the AP and any attempts to reauthenticate will fail.

This section covers:

## Viewing a List of Subscription Packages

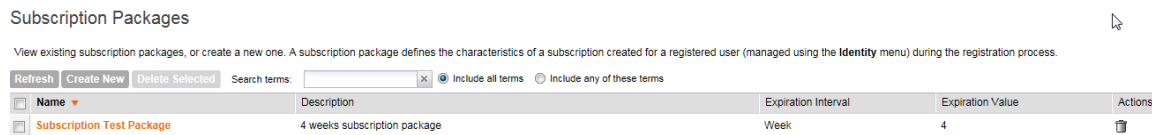
A subscription package defines the characteristics of a subscription that has been created for a registered user.

Follow these steps to view a list of existing packages.

Go to **Identity > Subscription Packages**.

The **Subscription Packages** page displays a table of existing packages along with their basic details, including:

- **Name:** The name of the package.
- **Description:** A brief description of the package.
- **Expiration Time:** The time unit used in conjunction with **Expiration Value** to define when the package will expire.
- **Expiration Value:** The value used in conjunction with **Expiration Time** to define when the package will expire.



Subscription Packages

View existing subscription packages, or create a new one. A subscription package defines the characteristics of a subscription created for a registered user (managed using the **Identity** menu) during the registration process.

Refresh Create New Delete: Selected Search terms:   Include all terms  Include any of these terms

Name	Description	Expiration Interval	Expiration Value	Actions
<input type="checkbox"/> Subscription Test Package	4 weeks subscription package	Week	4	<input type="checkbox"/> <input type="checkbox"/> <input type="checkbox"/>

Figure 193: Viewing existing subscription packages

## Creating a Subscription Package

A subscription package defines the characteristics of a subscription that has been created for a registered user.

Follow these steps to create a package.

1. Go to **Identity > Subscription Packages**.  
The **Subscription Packages** page appears.
2. Click **Create New**.
3. In **Package Name**, type a name for the subscription package that you are creating.
4. In **Description**, type a description for the package.  
This is an optional field.
5. In **Expiration Time**, set the time unit to use for the package expiration.  
Options available include:
  - Hour
  - Day
  - Week
  - Month
  - Year
  - Never
6. In **Expiration Value**, set the actual value to use in combination with the **Expiration Time**.

For example, if you selected **Day** in **Expiration Time** and you typed **7** in **Expiration Value**, the package will expire 7 days after it is assigned to a user.

7. Click **Save**.

The page refreshes, and the package that you created appears in the view list.

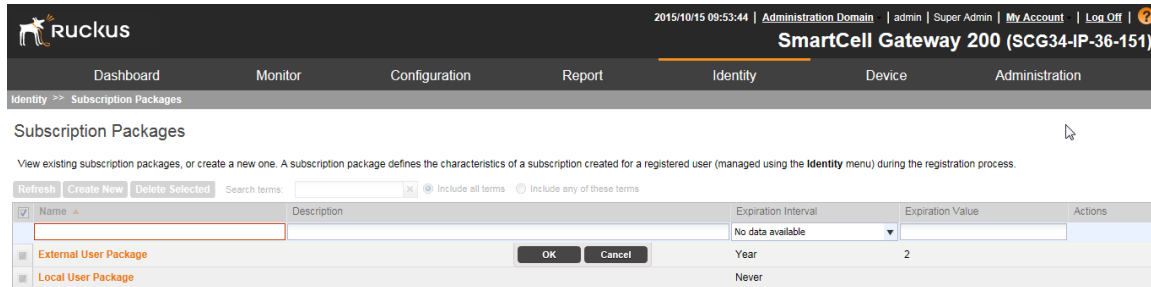


Figure 194: Creating a subscription package

## Editing a Subscription Package

A subscription package defines the characteristics of a subscription that has been created for a registered user.

Follow these steps to edit an existing package.

1. Go to **Identity > Subscription Packages**.  
The **Subscription Packages** page appears.
2. Locate the package that you want to edit.
3. Under the **Name** column, click the name of the package that you want to edit.  
The entire row becomes editable.
4. Edit the profile by changing any of the following options:
  - **Name**
  - **Description**
  - **Expiration Interval**
  - **Expiration Value**

5. Click **Save**.

You have completed editing a package.

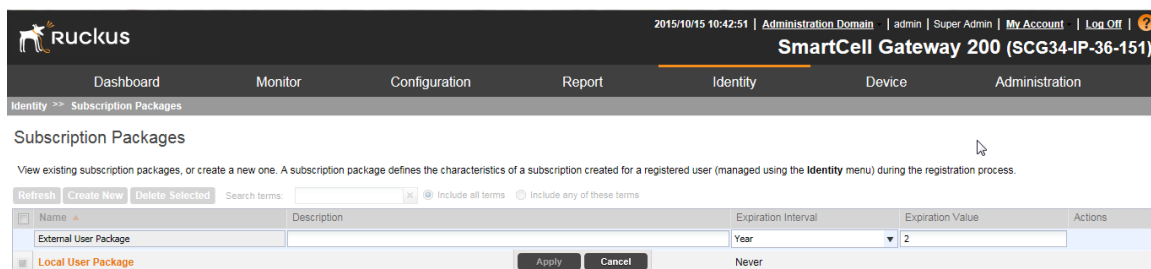



Figure 195: Editing a subscription package

## Deleting a Subscription Package

Follow these steps to delete a subscription package.

1. Go to **Identity > Subscription Packages**.  
The **Subscription Packages** page appears.
2. Locate the package that you want to delete.
3. Under the **Actions** column, click the  icon that is in the same row as the package name.  
The following confirmation message appears: Are you sure you want to delete the selected row?
4. Click **Yes**.  
The page refreshes, and the package that you deleted disappears from the table.

You have completed deleting a package.

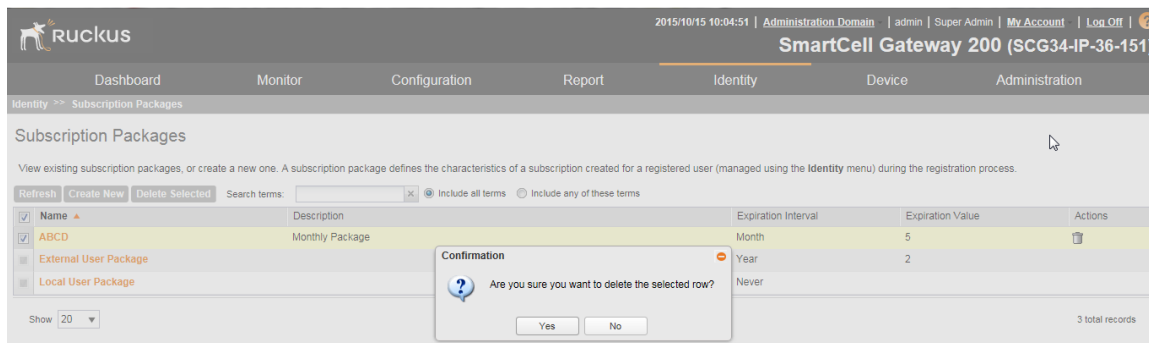


Figure 196: Deleting a subscription package

# Performing Administrative Tasks

In this chapter:

- [Backing Up and Restoring Clusters](#)
- [Backing Up and Restoring the Controller's Network Configuration from an FTP Server](#)
- [Backing Up and Restoring System Configuration](#)
- [Resetting a Node to Factory Settings](#)
- [Upgrading the Controller](#)
- [Uploading AP Patch Files](#)
- [Working with Logs](#)
- [Managing AP Certificate Replacement](#)
- [Managing Licenses](#)

In this chapter:

## Backing Up and Restoring Clusters

Back up the controller cluster periodically to ensure that you can restore the control plane, data plane, and AP firmware versions as well as the system configuration in the cluster if a system failure occurs.

This section covers the following topics:

**NOTE:** You can also perform these procedures from the SCG-200 command line interface. Note, however, that you will need to execute the commands on each node. For more information, see the SmartCell Gateway 200 Command Line Interface Reference Guide for this release.

### Creating a Cluster Backup

Follow these steps to back up an entire controller cluster.

1. Take note of the current system time.

You can view the **General System Settings** page under **Configuration > System**. For more information, see [Setting the System Time](#) on page 203.

2. Go to **Administration > Cluster Backup and Restore**.
3. Click **Back Up Entire Cluster**.

The following confirmation message appears: Are you sure you want to back up the cluster?

4. Click **Yes**.

The following message appears: The cluster is in maintenance mode. Please wait a few minutes.

When the cluster backup process is complete, a new entry appears in the **Cluster Backups** section with a Created On value that is approximate to the time when you started the cluster backup process.

**NOTE:** If you have an FTP server, back up the entire cluster and upload the backup files from all the nodes in a cluster to a remote FTP server.

You have completed backing up the controller cluster.

Cluster Backups

This table lists the available cluster backups. You can use any of these backups to restore the controller cluster.


Patch Version	Created On	File Size	Actions
3.2.0.0.750	2015/10/05 18:07:15	1.4GB	  
3.2.0.0.746	2015/09/24 12:34:01	1.0GB	  
3.2.0.0.740	2015/09/21 11:04:04	997.4MB	  
3.2.0.0.728	2015/09/15 14:55:19	931.4MB	  

Show 20 << | 1 | >> 4 total records

**Figure 197: A new entry appears in the Cluster Backups section**

## Restoring a Cluster Backup

Follow these steps to restore a cluster backup.

1. Go to **Administration > Cluster Backup and Restore**.
2. In the **Cluster Backups** section, locate the cluster backup that you want to restore.
3. Click the  icon that is in the same row as the cluster backup.

The following confirmation message appears: Are you sure you want to restore the cluster?

4. Click **Yes**.

The page refreshes, and then the following message appears: System is restoring! Please wait...

**NOTE:** The cluster restore process may take several minutes to complete.

When the restore process is complete, the controller logs you off the web interface automatically.

Do not refresh the controller web interface while the restore process is in progress. Wait for the restore process to complete successfully.

5. Log back on to the controller web interface.

**NOTE:** If the web interface displays the message `Cluster is out of service. Please try again in a few minutes.` appears after you log on to the controller web interface, wait for about three minutes. The dashboard will appear shortly. The message appears because the controller is still initializing its processes.

6. Go to **Administration** > **Upgrade**, and then check the **Current System Information** section and verify that all nodes in the cluster have been restored to the previous version and are all in service.
7. Go to **Administration** > **Diagnostics**, and then click **Application Logs & Status** on the sidebar.
8. Check the **Health Status** column and verify that all of the controller processes are online.  
(See [#unique\\_407/unique\\_407\\_Connect\\_42\\_ID-2649-00000068](#) on page 344).

You have completed restoring the cluster backup.

**Cluster Backups**

This table lists the available cluster backups. You can use any of these backups to restore the SCG cluster.

[Refresh](#)





























Patch Version	Created On	File Size	Actions
2.1.1.0.107	2013/11/27 16:03:42	1.16G	 
2.1.1.0.94	2013/11/26 17:03:57	1.11G	 
2.1.1.0.79	2013/11/26 15:15:53	1.1G	 
2.1.1.0.79	2013/11/16 12:29:49	1.05G	 
2.1.0.0.295	2013/11/15 19:23:31	906.46M	 
2.1.0.0.295	2013/11/13 10:57:27	851.15M	 
2.1.0.0.295	2013/11/08 20:06:07	856.38M	 
2.1.0.0.295	2013/11/08 14:47:46	881.46M	 
2.1.0.0.295	2013/11/07 16:27:55	935.7M	 
2.1.0.0.295	2013/11/06 11:46:40	874M	 
2.1.0.0.295	2013/11/05 12:24:30	897.06M	 
2.1.0.0.295	2013/10/28 15:46:52	858.87M	 
2.1.0.0.295	2013/10/28 12:09:57	905.73M	 
2.1.0.0.279	2013/10/28 10:52:01	789.3M	 

Figure 198: Under Actions, click the calendar icon to start the cluster restore process

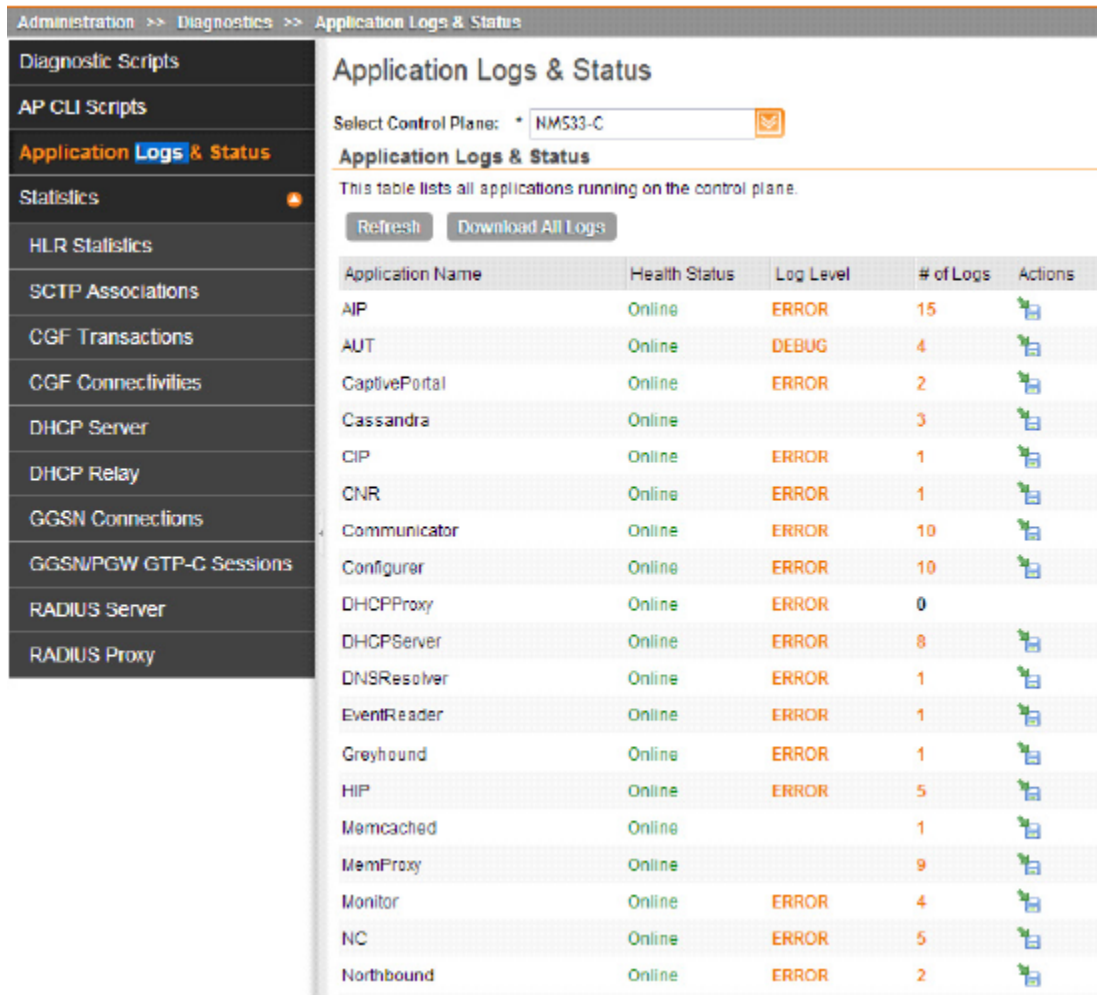


Figure 199: After the upgrade is complete, go to the Application Logs & Status page and verify that all of the controller processes are online

### Deleting a Cluster Backup

Follow these steps to delete a cluster backup.

1. Go to **Administration > Cluster Backup and Restore**.
2. In the **Cluster Backups** section, locate the cluster backup that you want to delete.
3. Click the icon that is in the same row as the cluster backup.

The following confirmation message appears: Are you sure you want to delete the selected resource?

4. Click **Yes**.

The page refreshes and the row is deleted from the **Cluster Backups** list.



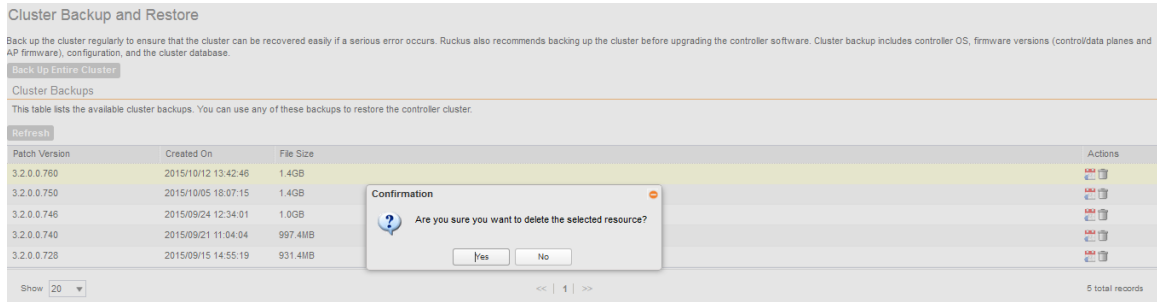


Figure 200: A confirmation message appears after you click the trash bin icon

## Backing Up and Restoring the Controller's Network Configuration from an FTP Server

In addition to backing up and restoring the controller's network configuration from its own database, the controller supports backup and restore of its network configuration from an FTP server using the CLI.

This section describes the requirements for backing up and restoring the controller's network configuration from an FTP server, the information that is included in the backup file, and how to perform the backup and restore process.

To back up and restore the controller's network configuration from an FTP server, the controller must have already been set up and in service. In case of a multi-node cluster, all the nodes in the cluster must be in service.

[Table 20: Information that is backed up to the FTP server](#) on page 345 lists the network configuration that is backed up from the control and data planes when you perform a backup procedure to an FTP server.

**Table 20: Information that is backed up to the FTP server**

Control Plane	Data Plane
<ul style="list-style-type: none"> <li>Control interface</li> <li>Cluster interface</li> <li>Management interface</li> <li>Static routes</li> <li>User-defined interfaces</li> </ul>	<ul style="list-style-type: none"> <li>Primary interface</li> <li>Static routes</li> <li>Internal subnet prefix</li> </ul>

### Backing Up to an FTP Server

Follow these steps to back up the controller network configuration to an FTP server.

1. Log on to the controller from the controller's command line interface (CLI). For more information, see the corresponding *Command Line Interface Reference Guide* for your controller platform.
2. At the prompt, enter `en` to enable privileged mode.

```
cb172651> en
Password: *****
```

Figure 201: Enable privileged mode

3. Enter - to display the statuses of the node and the cluster.

Before continuing to the next step, verify that both the node and the cluster are in service.

```
cb172651# show cluster-state
Current Node Status : In service
Cluster Status      : In service
Cluster Operation   : None
System Mode         : None
```

Figure 202: Verify that both the node and the cluster are in service

4. Enter backup network to back up the controller network configuration, including the control plane and data plane information.

The controller creates a backup of its network configuration on its database.

```
#####
#      Welcome to SCG      #
#####
Password:
Please wait. CLI initializing...

Welcome to the Ruckus SmartCell Gateway 200 Command Line Interface
Version: 2.5.0.0.402

cb172651> en
Password: *****

cb172651# backup network
Do you want to backup network configurations (or input 'no' to cancel)? [yes/no] yes
Starting to backup network configurations...
Successful operation
```

Figure 203: Run backup network

5. Enter show backup-network to view a list of backup files that have been created.

Verify that the **Created On** column displays an entry that has a time stamp that is approximate to the time you started the backup.

```
cb172651# show backup-network
No.    Created on                Patch Version             File Size
-----
1      2013-10-23 11:01:14 GMT   2.5.0.0.402              1.2K
2      2013-10-24 02:40:22 GMT   2.5.0.0.402              1.2K
```

Figure 204: Enter the show backup-network command

- Enter `copy backup-network {ftp-url}`, where `{ftp-url}` (remove the braces) is the URL or IP address of the FTP server to which you want to back up the cluster configuration.

The **CLI** prompts you to choose the number that corresponds to the backup file that you want to export to the FTP server.

- Enter the number of the backup file that you want to export to the FTP server.

The controller encrypts the backup file, and then exports it to the FTP server. When the export process is complete, the following message appears on the **CLI**:

```
Succeed to copy to remote FTP server
Successful operation
```

```
cb172651# copy backup-network ftp://david-ko:AAAAaa123@10.2.2.162
No.      Created on          Patch Version      File Size
-----
1        2013-10-23 11:01:14 GMT  2.5.0.0.402      1.2K
2        2013-10-24 02:40:22 GMT  2.5.0.0.402      1.2K

Please choose a backup to send to remote FTP server or 'No' to cancel: 2
Starting to copy the chosen backup to remote FTP server...
Starting to encrypt backup file...
Succeed to copy to remote FTP server
Successful operation
```

**Figure 205:** Succeed to copy to remote FTP server indicates that you have exported the backup file to the FTP server successfully

- Using an FTP client, log on to the FTP server, and then verify that the backup file exists.

The file format of the backup file is

```
network_<YYYYMMDDHHmmss>_<controller-version>.bak.
```

For example, if you created the backup file on October 24th 2013 at 02:40:22 and the controller version is 2.5.0.0.402, you should see a file named

```
network_20131024024022_2.5.0.0.402.bak
```

You have completed backing up the controller to an FTP server.

## Restoring from an FTP Server

Before you continue, take note of the following limitations with restoring a backup file of the controller network configuration from an FTP server:

- Only release 2.1 and later support restoring from an FTP server.
- In this current release, restoring the entire cluster from an FTP server is unsupported. The restore process must be performed on one node at a time.
- Restoring from an FTP server can only be performed using the **CLI**.

**CAUTION:** Restoring a backup file to the controller requires restarting all of the controller services.

Follow these steps to restore a backup file of the controller's network configuration that you previously uploaded to an FTP back to the controller.

1. Log on to the controller from the **CLI**. For more information, see the corresponding *Command Line Interface Reference Guide* for your controller platform.
2. At the prompt, enter `en` to enable privileged mode.

```
cb172651> en
Password: *****
```

**Figure 206: Enable privileged mode**

3. Enter `show cluster-state` to display the statuses of the node and the cluster.  
Before continuing to the next step, verify that both the node and the cluster are in service.

```
cb172651# show cluster-state
Current Node Status : In service
Cluster Status      : In service
Cluster Operation   : None
System Mode         : None
```

**Figure 207: Verify that both the node and the cluster are in service**

4. Enter the following command to log on to the FTP server and check for available backup files that can be copied to the controller:

```
copy <ftp-url> backup-network
```

5. If multiple backup files exist on the FTP server, the **CLI** prompts you to select the number that corresponds to the file that you want to copy back to the controller.

If a single backup file exists, the **CLI** prompts you to confirm that you want to copy the existing backup file to the controller.

When the controller finishes copying the selected backup file from the FTP server back to the controller, the following message appears: Succeed to copy the chosen file from the remote FTP server

6. Enter `show backup-network` to verify that the backup file was copied back to the controller successfully.

```
cb172651# copy ftp://david-ko:AAAAaa123@10.2.2.162 backup-network
Only one NetworkBackup file (network_20131024024022_2.5.0.0.402.bak) is found. Do you want to copy (or input 'no' to cancel)? [yes/no] yes
Starting to copy the chosen NetworkBackup file (network_20131024024022_2.5.0.0.402.bak) from remote FTP server...
Succeed to copy the chosen file from remote FTP server

cb172651# show backup-network
No.      Created on                Patch Version              File Size
-----
1        2013-10-24 02:40:22 GMT   2.5.0.0.402               1.2K
```

**Figure 208: Verify that the backup file was copied to the controller successfully**

7. Run `restore network` to start restoring the contents of the backup file to the current controller.  
The **CLI** displays a list of backup files, and then prompts you to select the backup file that you want to restore to the controller.

8. Enter the number that corresponds to the backup file that you want to restore.

```

cb172651# restore network
No.   Created on                Patch Version                File Size
-----
1     2013-10-24 02:40:22 GMT    2.5.0.0.402                 1.2K

Please choose a backup to restore or 'No' to cancel: 1
The matched network setting for current system serial number is found from the chosen backup as below:

[Control Plane Interfaces]
Interface IP Mode IP Address      Subnet Mask      Gateway
-----
Control   Dhcp
Cluster   Dhcp
Managemen Dhcp
t

Default Gateway Interface : Management
Primary DNS Server        : 172.17.17.16
Secondary DNS Server      :
Internal Subnet Prefix    : 10.254.1

[Control Plane User Defined Interfaces]
Name      IP Address      Subnet Mask      Gateway      VLAN  Interface  Service
-----
v100     172.17.26.103   255.255.255.0    172.17.26.1   100   Control    Hotspot
v102     172.17.26.102   255.255.255.0    172.17.26.1   102   Control    Hotspot
v101     172.17.26.101   255.255.255.0    172.17.26.1   101   Managemen  Hotspot
t

Please confirm this network setting, and this action will restart all services that will cause current SSH connection closed.
l)? [yes/no] yes
Not all services are healthy. Do you want to continue (or input 'no' to cancel)? [yes/no] yes
Process had been started before and running...
Starting to stop all SCG services...

```

**Figure 209: Enter the number that corresponds to the backup file that you want to restore**

The **CLI** displays the network configuration that the selected backup file contains.

If the serial number of the current controller matches the serial number contained in one of the backup files, the **CLI** automatically selects the backup file to restore and displays the network configuration that it contains.

9. Type `yes` to confirm that you want to restore the selected backup file. The controller starts the restore process and performs the following steps:
- Stop all services.
  - Back up the current network configuration.

This will enable the controller to roll back to the current configuration, in case there is an issue with the restore process.

- Clean up the current network configuration.

The controller deletes its previous network configuration, including static routes, name server, user defined interfaces, etc.

10. Restore the network configuration contained in the selected backup file.  
 11. Restart all services.

When the restore process is complete, the following message appears on the CLI: All services are up!

```

ca172651# restore network
Process had been started before and running...
Starting to stop all SCG services...
Checking action...Done!
Checking type...Done!
Checking creator...Done!
Checking reason...Done!
service_stop flag file already exists, skip create it
07:20:24.342 [main] INFO c.ruckus:wireless.wsg.cluster.Cluster - Load cluster environment file [/opt/ruckuswireless/wsg/conf/configurableSetting.properties]
wait for (CaptivePortal,Cassandra,Communicator,Configurer,EventReader,Greyhound,Memcached,Northbound,Scheduler,SubscriberManagement) Down!
wait for (Cassandra,Communicator,Configurer,EventReader,Greyhound,Memcached) Down!
wait for (Cassandra,Communicator,Configurer,Memcached) Down!
wait for (Cassandra,Configurer,Memcached) Down!
wait for (Cassandra,Configurer,Memcached) Down!
wait for (Cassandra,Configurer,Memcached) Down!
wait for (Cassandra,Configurer,Memcached) Down!
wait for (Configurer) Down!
All services are down!
Stop service SCG done!
Starting to restore current system network setting...
Starting to backup current network settings for rollback
Starting to restore network configuration
Starting to delete the routes of control plane
Starting to delete the user interfaces of control plane
Starting to update the IP settings of control plane
Starting to update the DNS of control plane
Starting to update the internal subnet of control plane
Restarting control plane network
Starting to update the user interfaces of control plane
Restarting control plane network
Success to restore network configuration
Starting to start all SCG services...
Checking action...Done!
Checking type...Done!
Checking creator...Done!
Checking reason...Done!
service_start flag file already exists, skip create it
wait for (CaptivePortal,Cassandra,Communicator,EventReader,Greyhound,Memcached,Monitor,Northbound,Scheduler,SubscriberManagement,SubscriberPortal,Web) Up!
wait for (CaptivePortal,Communicator,EventReader,Greyhound,Memcached,Monitor,Northbound,Scheduler,SubscriberManagement,SubscriberPortal,Web) Up!
wait for (CaptivePortal,Communicator,EventReader,Greyhound,Memcached,Monitor,Northbound,Scheduler,SubscriberManagement,SubscriberPortal,Web) Up!
wait for (CaptivePortal,Communicator,EventReader,Greyhound,Memcached,Monitor,Northbound,Scheduler,SubscriberManagement,SubscriberPortal,Web) Up!
wait for (Monitor) Up!
wait for (Monitor) Up!
wait for (Monitor) Up!
All services are up!

```

Figure 210: The controller performs several steps to restore the backup file

- 12 Do the following to verify that the restore process was completed successfully:
- Run `show cluster-state` to verify that the node and the cluster are back in service.
  - Run `show interface` to verify that all of the network configuration settings have been restored.

```
cb172651# show cluster-state
Current Node Status : In service
Cluster Status      : In service
Cluster Operation   : None
System Mode         : None

cb172651# show interface
Interfaces
-----
Interface   : Control
IP Mode     : Dhcp
IP Address  : 10.2.7.155
Subnet Mask : 255.255.0.0
Gateway     : 10.2.0.1

Interface   : Cluster
IP Mode     : Dhcp
IP Address  : 10.2.2.215
Subnet Mask : 255.255.0.0
Gateway     : 10.2.0.1

Interface   : Management
IP Mode     : Dhcp
IP Address  : 172.17.26.51
Subnet Mask : 255.255.254.0
Gateway     : 172.17.26.1

Default Gateway Interface : Management
Primary DNS Server        : 172.17.17.16
Secondary DNS Server      :

User Defined Interfaces
-----
IP Address      : 172.17.26.101
Subnet Mask     : 255.255.255.0
Gateway         : 172.17.26.1
VLAN            : 101
Physical Interface : Management
Service         : Hotspot

IP Address      : 172.17.26.103
Subnet Mask     : 255.255.255.0
Gateway         :
VLAN            : 100
Physical Interface : Control
```

**Figure 211: Verify that the node and cluster are back in service and that the network configuration has been restored successfully**

You have completed importing and applying the network configuration backup from the FTP server to the controller.

## Backing Up and Restoring System Configuration

Ruckus Wireless® strongly recommends that you back up the controller database periodically. This will help ensure that you can restore the system configuration settings easily if the database becomes corrupted for any reason.

[Table 21: What's backed up in the system configuration backup file](#) on page 352 lists the information that is included in the system configuration backup file.

**Table 21: What's backed up in the system configuration backup file**

Configuration Data	Administration Data	Report Data	Identity Data
<ul style="list-style-type: none"> <li>• AP zones</li> <li>• 3rd party AP zones</li> <li>• Services and profiles</li> <li>• Packages</li> <li>• System settings</li> <li>• Management domains</li> <li>• Administrator accounts</li> <li>• Mobile virtual network operator accounts</li> </ul>	<ul style="list-style-type: none"> <li>• Cluster backups</li> <li>• System configuration backups</li> <li>• Upgrade settings and history</li> <li>• Uploaded system diagnostic scripts</li> <li>• Installed licenses</li> </ul>	<ul style="list-style-type: none"> <li>• Saved reports</li> <li>• Historical client statistics</li> <li>• Network tunnel statistics</li> </ul>	<ul style="list-style-type: none"> <li>• Created profiles</li> <li>• Generated guest passes</li> </ul>

**CAUTION:** A system configuration backup does not include control plane settings, data plane settings, and user-defined interface settings.

**NOTE:** In addition to the web interface, you can also perform system configuration backup and restore from the command line interface of the SCG-200. For more information, see the *SmartCell Gateway 200 Command Line Interface Reference Guide* for this release.

### Creating a System Configuration Backup

Follow these steps to create a backup of the controller database.

1. Go to **Administration > System Configuration Backup and Restore**.
2. Click **Back Up Configuration**.

The following confirmation message appears: Are you sure you want to back up the controller's configuration?

3. Click **OK**.

A progress bar appears as the controller creates a backup of the its database.



## System Configuration Backup and Restore

Back up the controller configuration regularly to ensure that cluster-wide settings can be restored if a serious configuration error occurs. (the cluster OS, firmware, or database).

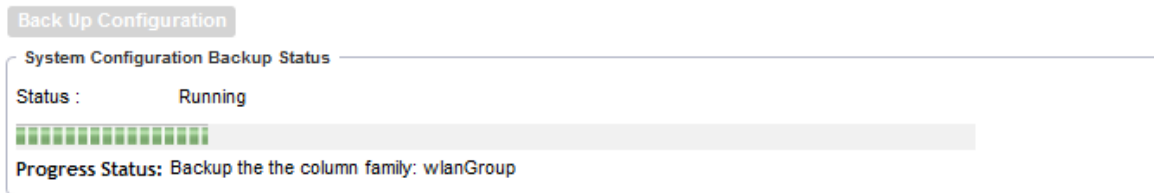


Figure 212: A progress bar appears as the controller backs up its database

When the backup process is complete, the progress bar disappears, and the **Configuration Backup Status** section appears and shows the following information:

- Latest backup started: Date and time when configuration backup was initiated
- Finished at: Date and time when configuration backup was completed
- Status: Shows either *Successful* or *Failed*
- Progress Status: Shows the current status of the backup process

The backup file appears under the **Configuration Backups** section.

System Configuration Backups  
This table lists the available configuration backups. You can use any of these backups to restore cluster-wide settings.

Created On	Controller Version	Control Plane Software Ver...	Data Plane Software Version	Created By	Type	Backup Elapsed	File Size	Actions
2015/10/12 14:12:20	3.2.0.0.760	3.2.0.0.812	3.2.0.0.784	admin	Manual Backup	1s	103.5KB	
2015/10/12 14:11:54	3.2.0.0.760	3.2.0.0.812	3.2.0.0.784	admin	Manual Backup	1s	103.5KB	

Show 20 << | 1 | >> 2 total records

Figure 213: The backup file appears in the System Configuration Backups section

### Exporting the Configuration Backup to an FTP Server Automatically

In addition to backing up the configuration file manually, you can configure the controller to export the configuration file to an FTP server automatically whenever you click **Back Up Configuration**.

Follow these steps to back up the configuration file to an FTP server automatically.

1. Go to **Administration > System Configuration Backup and Restore**.
2. Go to the **Auto Export Backup** section.
3. In **Auto Export Backup**, click **Enable**.
4. In **FTP Server**, select the FTP server to which you want to export the backup file.

The FTP server options that appear here are those that you created in [Configuring FTP Services](#) on page 165.

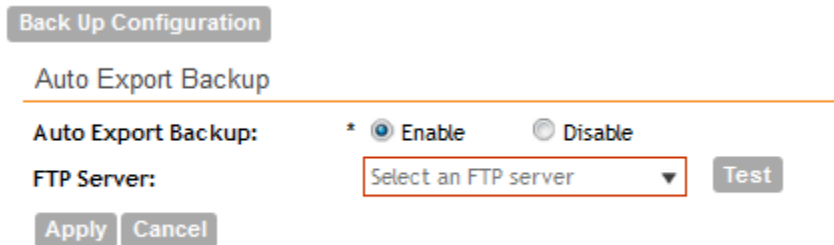
5. Click **Test**.

The controller attempts to establish connection to the FTP server using the user name and password that you supplied. If the connection attempt is successful, the following message appears: `FTP server connection established successfully.`

If the connection attempt is unsuccessful, verify that the FTP server details (including the user name and password) are correct, and then click **Test** again.

6. After you verify the controller is able to connect to the FTP server successfully, click **Apply** to save the FTP server settings.

You have completed configuring the controller to export the configuration backup file to an FTP server. When you click the **Back Up Configuration** button (see [Creating a System Configuration Backup](#) on page 352), a copy of the configuration backup will be uploaded to the FTP server automatically.



The screenshot shows a configuration window titled "Back Up Configuration" with a sub-section "Auto Export Backup". Under "Auto Export Backup:", there are two radio buttons: "Enable" (which is selected) and "Disable". Below this is the "FTP Server:" label followed by a dropdown menu that currently displays "Select an FTP server". To the right of the dropdown is a "Test" button. At the bottom left of the configuration area are "Apply" and "Cancel" buttons.

Figure 214: Configure the FTP server settings in the Auto Export Backup section

## Scheduling a Configuration Backup

You also have the option to configure the controller to backup its configuration automatically based on a schedule you specify.

Follow these steps to schedule a configuration backup.

1. Go to **Administration > System Configuration Backup and Restore**.
2. Scroll down to the **Schedule Backup** section.
3. In **Schedule Backup**, click **Enable**.
4. In **Interval**, set the schedule when the controller will automatically create a backup of its configuration. Options include:
  - **Daily**
  - **Weekly**
  - **Monthly**
5. Define the schedule further by configuring the following options:
  - **Every:** If you selected **Weekly** in the previous step, select the day of the week when the controller will generate the backup. If you selected **Monthly**, select the day of the month.
  - **Hour:** Select the hour of the day when the controller will generate the backup.
  - **Minute:** Select the minute of the hour.
6. Click **Apply**.

You have completed configuring the controller to create a backup automatically. When a scheduled configuration backup is generated, it appears in the **System Configuration Backups** section.

**Schedule Backup**

---

Note: the schedule will be executed based on system timezone.

Schedule Backup: \*  Enable  Disable

Interval:  @ Hour:  Minute:

Figure 215: Configure the schedule in the Schedule Backup section


## Downloading a Copy of the Configuration Backup

After you create a configuration backup, you have the option to download the backup file from the **System Configuration Backups** section.

Follow these steps to download the backup file to the computer that you are using to access the controller web interface.

1. Go to **Administration > System Configuration Backup and Restore**.
2. Scroll down to the **System Configuration Backups** section.
3. Locate the entry for the backup file that you want to download.

If multiple backup files appear on the list, use the date when you created the backup to find the backup entry that you want.

4. Click the  icon that is in the same row as the backup file that you want to download.

Your web browser downloads the backup file to its default download folder.

**NOTE:** When your web browser completes downloading the backup file, you may see a notification at the bottom of the page, similar to what is shown in [Table 215](#).

5. Check the default download folder for your web browser and look for a file that resembles the following naming convention: {Cluster Name}\_BackupConf\_{MMdd}\_db\_{MM}\_{dd}\_{HH}\_{mm}.bak

For example, if the controller cluster is named `ClusterA` and you created the configuration backup on September 7 at 11:08 AM, the backup file name will be:





`ClusterA_BackupConf_0907_db_09_07_11_08.bak`

You have completed downloading a copy of the configuration backup.

System Configuration Backups

This table lists the available configuration backups. You can use any of these backups to restore cluster-wide settings.

Refresh Upload

Created On	SCG Versi...	Control Pla...	Data Plan...	Created By	Type	Backup Elap...	File Size	Actions
2015/03/16 00:20:00	3.1.0.0.204	3.1.0.0.425	3.1.0.0.496		Scheduled Backup	1	432.7KB	 
2015/02/24 01:24:57	3.1.0.0.166	3.1.0.0.353	3.1.0.0.427	admin	Manual Backup		332.3KB	 

Show 20


<< | 1 | >>

SCG147-19\_Configur...b...

Figure 216: When your browser completes downloading the backup file, you may see a notification at the bottom of the web page

## Restoring a System Configuration Backup

Follow these steps to restore a backup controller database.

1. Go to **Administration > System Configuration Backup and Restore**.
2. In the **System Configuration Backups** section, locate the backup file that you want to restore.
3. Once you locate the backup file, click the  icon that is in the same row as the backup file.  
A confirmation message appears.

**NOTE:** Take note of the backup version that you are using. At the end of this procedure, you will use the backup version to verify that the restore process was completed successfully.

4. Click **Yes**.

The following message appears: `System is restoring. Please wait...` When the restore process is complete, the controller logs you off the web interface automatically.

5. Log on to the controller web interface.
6. Check the web interface pages (for example, **Configuration, Report, and Identity**) and verify that the setting and data contained in the backup file have been restored successfully to the controller.

You have completed restoring a system configuration backup file.

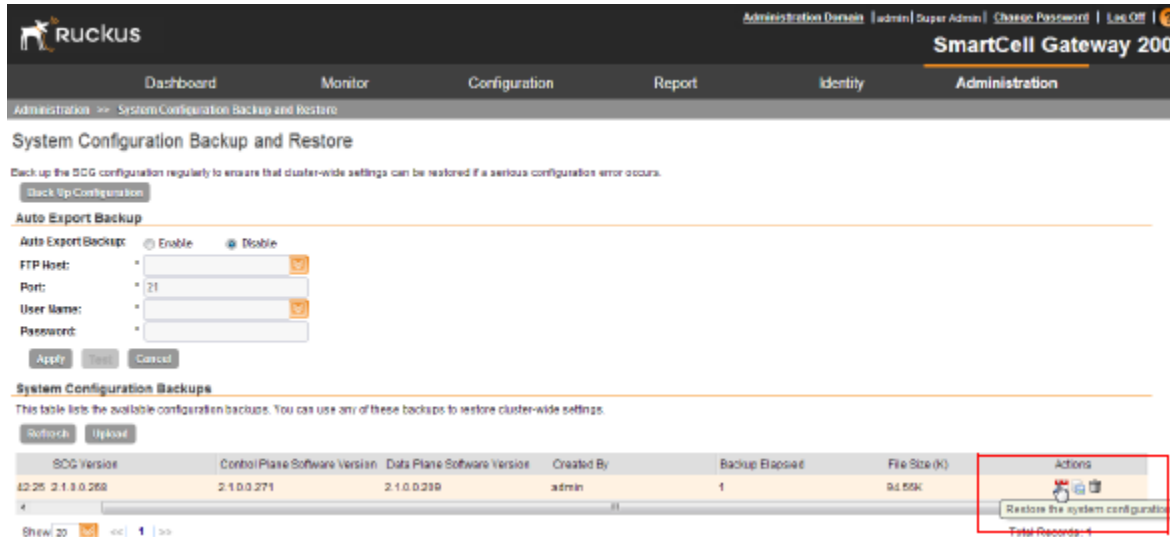



Figure 217: Under the Actions column, click the configuration restore icon

## Deleting a Configuration Backup

Follow these steps to delete a backup of the controller database

1. Go to **Administration > System Configuration Backup and Restore**.
2. In the **System Configuration Backups** section, locate the backup version that you want to delete.
3. Once you locate the backup file, click the  icon under the **Actions** column.  
A confirmation message appears.
4. Click **Yes**.

The page refreshes, and the backup file that you deleted disappears from the **System Configuration Backups** section.

You have completed deleting a backup file.

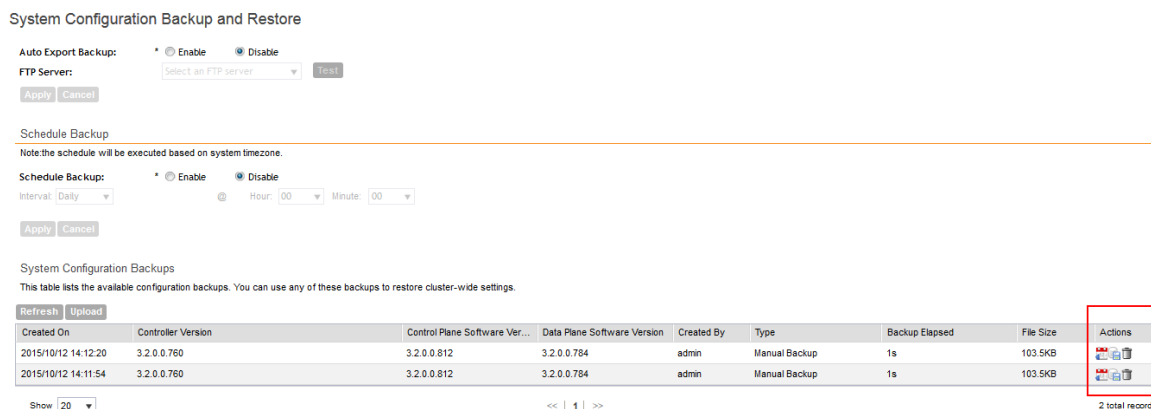


Figure 218: Under the Actions column, click the trash bin icon

## Resetting a Node to Factory Settings

You can reset a node in a cluster to factory settings by removing it from the cluster. When you reset a node to factory settings, all of its system configuration settings are completely erased and its IP address reverts to 192.168.2.2.

**NOTE:** The information in this section only applies to the SCG-200.

There are two methods to reset a node to factory settings:

**NOTE:** Resetting a node to factory settings will erase all of its system configuration settings, backup files, and cluster settings. Before resetting a node to factory settings, Ruckus Wireless strongly recommends that you export all of the backup files on the controller to an FTP server using either the web interface or **CLI**.

### What Happens After Reset to Factory Settings

Before resetting a node to factory settings, consider the following notes:

- All of the system configuration settings of the node will be erased. This includes all of the domain, AP zone, user, and system settings, as well as all of the controller backups.
- The node will revert to its default IP address – 192.168.2.2.
- The controller software version will not be reset to its original software version when you first set it up. It will keep the existing software version at the time you reset it to factory settings.


### Using the Web Interface

To remove a node from a cluster, it must be a follower node. If the node that you want to remove from the cluster is the leader node, make sure you demote it to a follower node first before continuing with this procedure.

Follow these steps to remove a node from the cluster and reset it to factory settings.

1. Log on to the controller web interface of the leader node.
2. Go to **Configuration > System > Cluster Planes**.

The **Cluster Planes** page appears.

3. In the **Control Planes** table, locate the node that you want to reset to factory settings.
4. Click the  icon that is in the same row as the node that you want to reset to factory settings.

A confirmation message appears.

5. Click **Yes**.

The page refreshes, and then the node that you deleted disappears from the **Control Plane** table.

You have completed removing a node from the cluster and resetting it to factory settings.

**NOTE:** To set up this controller again, access the controller setup wizard <http://192.168.2.2:8080>. See the SCG-200 Getting Started Guide for more information.

After the controller is reset to factory settings, the controller allows the data blade interface IP address and gateway address to be on different subnets.

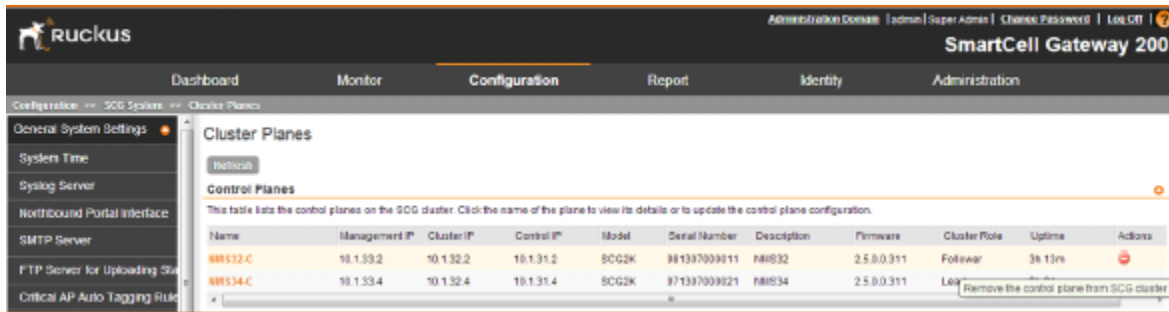


Figure 219: Click the delete icon

## Using the CLI

You can also use the command line interface to remove a node from a cluster and reset it to factory settings.

For information on gaining access to the CLI, see the corresponding *Command Line Interface Reference Guide* for your controller platform.

After you log on to the **CLI** of the node, follow these steps to reset a node to factory settings.

1. At the prompt, enter `set-factory`.

A confirmation message appears.

```
NMS34# set-factory
Do you want to do factory reset (or input 'no' to cancel)? [yes/no]
```

Figure 220: Enter `set-factory` to reset the node to factory settings

2. Enter `yes` to confirm.
3. Enter `reload`.

This command is required to trigger the factory reset process.

A confirmation message appears.

4. Enter `yes` to confirm.

The controller reboots, and then triggers the factory reset process.

```
NMS34# reload
Do you want to gracefully reboot system after 30 seconds (or input 'no' to cancel)? [yes/no]
```

Figure 221: Enter `reload` to trigger the factory reset process

The controller reboots. You have completed resetting the node to factory default settings.

## Upgrading the Controller

Ruckus Wireless may periodically release controller software updates that contain new features, enhancements, and fixes for known issues.

These software updates may be made available on the Ruckus Wireless support website or released through authorized channels.

**CAUTION:** Although the software upgrade process has been designed to preserve all controller settings, Ruckus Wireless strongly recommends that you back up the controller cluster before performing an upgrade. Having a cluster backup will ensure that you can easily restore the controller system if the upgrade process fails for any reason. For information on how to back up the controller cluster, refer to [Creating a Cluster Backup](#) on page 341.

**CAUTION:** Ruckus Wireless strongly recommends that you ensure that all interface cables are intact during the upgrade procedure.

**CAUTION:** Ruckus Wireless strongly recommends that you ensure that the power supply is not disrupted during the upgrade procedure.

**NOTE:** If you are managing an SCG-200, you can also perform system configuration backup, restore, and upgrade from the controller command line interface. For more information, see the SmartCell Gateway 200 Command Line Interface Reference Guide.

## Performing the Upgrade

Follow these steps to upgrade the controller software.

**CAUTION:** Ruckus Wireless® strongly recommends backing up the controller cluster before performing the upgrade. If the upgrade process fails for any reason, you can use the latest backup file to restore the controller cluster. See [Backing Up and Restoring Clusters](#).

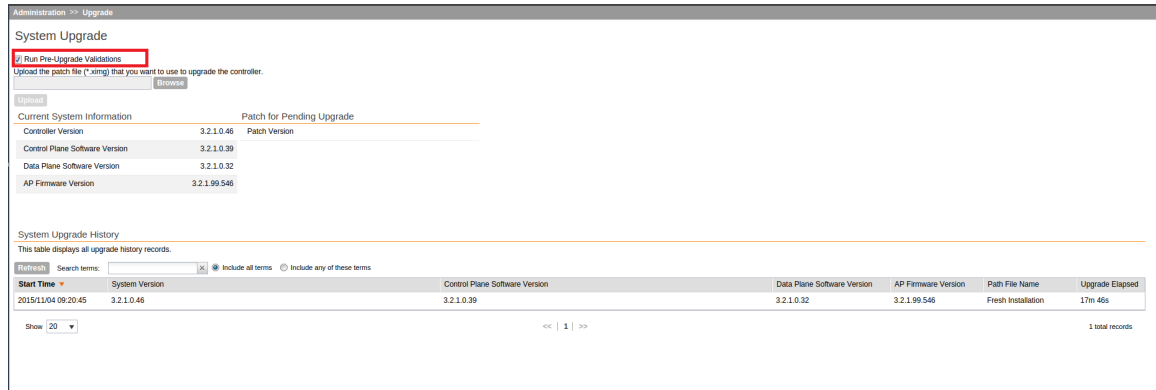
**NOTE:** Before starting this procedure, you should have already obtained a valid controller software upgrade file from Ruckus Wireless® Support or an authorized reseller.

1. Copy the software upgrade file that you received from Ruckus Wireless® to the computer where you are accessing the controller web interface or to any location on the network that is accessible from the web interface.
2. Go to **Administration > Upgrade**.
3. In the **Patch File Upload** section, click the **Browse** button, and then browse to the location of the software upgrade file.

Typically, the file name of the software upgrade file is `scg-installer_{version}.ximg`.



**NOTE:** Select the **Run Pre-Upgrade Validations** check box to verify if the data migration was successful. This option allows you to verify data migration errors before performing the upgrade. If data migration was unsuccessful, the following error is displayed: Exception occurred during the validation of data migration. Please apply the system configuration backup and contact system administrator.



**Figure 222: Pre-upgrade validation**

4. Select the software upgrade file, and then click **Open**.
5. Click **Upload** to upload the software upgrade file.

The controller uploads the file to its database, and then performs file verification. After the file is verified, the **Upgrade Pending Patch Information** section is populated with information about the upgrade file. The **Upgrade** and **Backup & Upgrade** buttons also appear in this section.

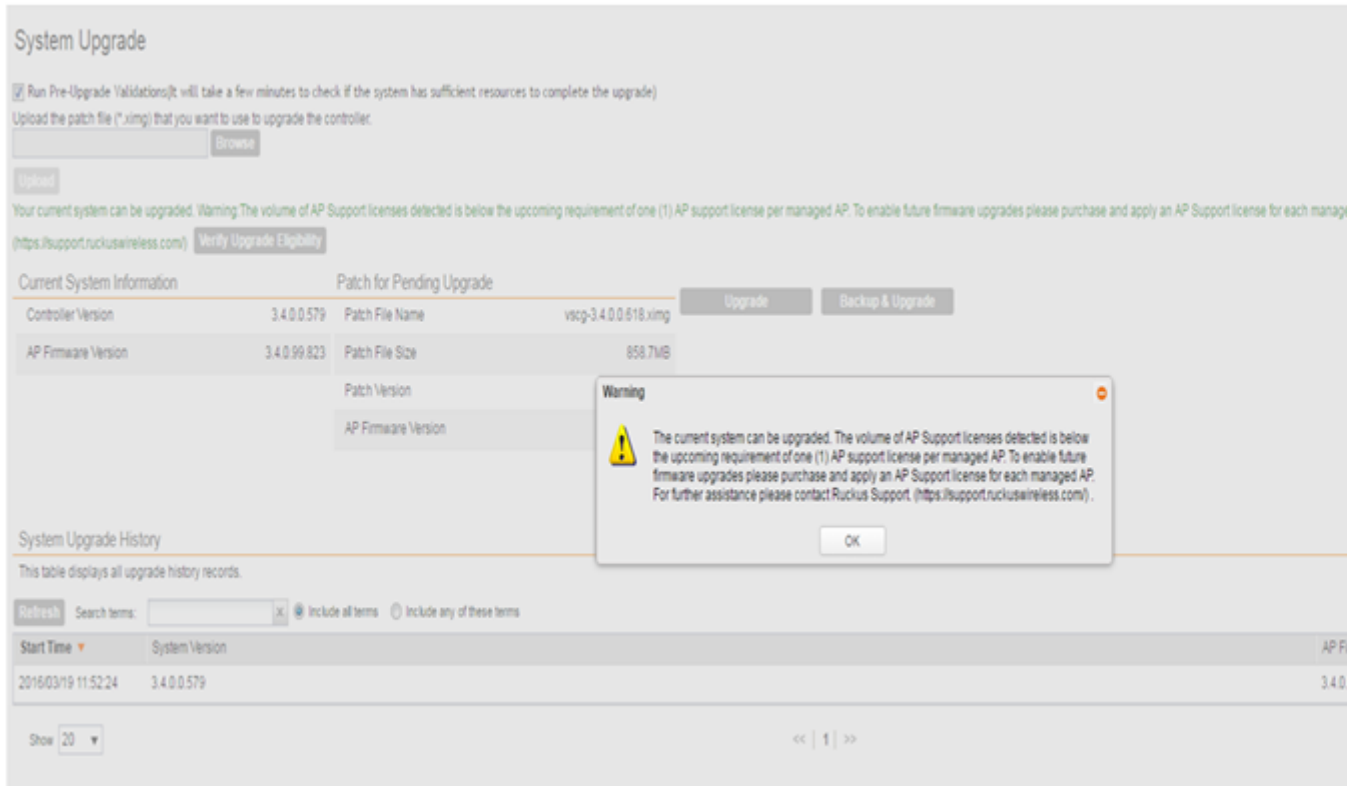


Figure 223: The Upgrade and Backup & Upgrade buttons appear on the right side

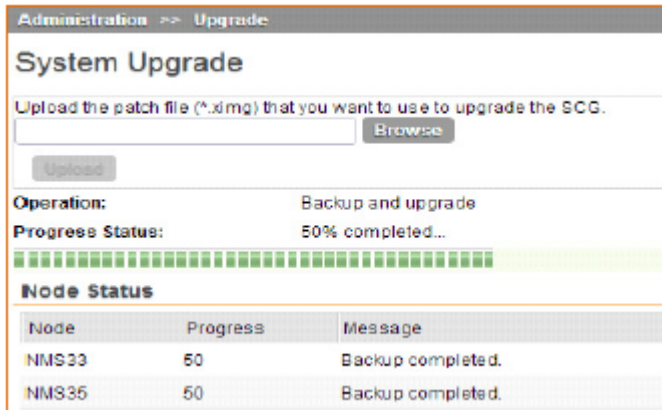
6. Start the upgrade process by clicking one of the following buttons:
  - **Upgrade:** Click this button to start the upgrade process without backing up the current controller cluster or its system configuration.
  - **Backup & Upgrade:** Click this button to back up the controller cluster and system configuration before performing the upgrade.

**CAUTION:** Ruckus Wireless® strongly recommends usage of backup and upgrade icon while performing the upgrade. If the upgrade process fails for any reason, you can use the latest backup file to restore the controller cluster. See [Backing Up and Restoring Clusters](#) on page 341.

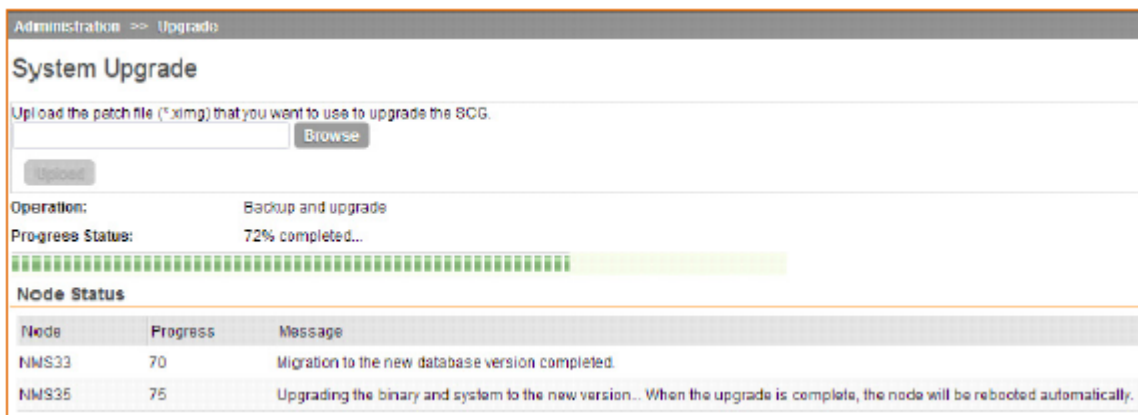
A confirmation message appears.

7. Click **Yes**.

The controller starts the process that you selected. The screens that appear next will depend on the process that you selected to upgrade immediately or to back up and then upgrade the controller.

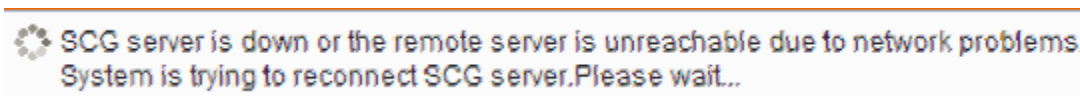


**Figure 224:** Backup completed status if you selected Backup & Upgrade



**Figure 225:** The System Upgrade page displays the status of the upgrade process

When the upgrade (or backup-and-upgrade) process is complete, the controller logs you off the web interface automatically. The controller web interface may display the message shown in [Figure 226: The controller web interface may display the following message as it completes the upgrade process](#) on page 363 as it completes the upgrade process. Wait for a few minutes until the web interface log on page appears.



**Figure 226:** The controller web interface may display the following message as it completes the upgrade process

When the controller log on page appears again, you have completed upgrading the controller. Continue to [Verifying the Upgrade](#) on page 364 to check if the upgrade was completed successfully.

## Verifying the Upgrade

Follow these steps to verify that the controller upgrade was completed successfully.

1. Log on to the controller web interface.
2. Go to **Administration > Upgrade**.
3. In the **Current System Information** section, check the value for Controller Version.

If the firmware version is newer than the firmware version that controller was using before you started the upgrade process, then the upgrade process was completed successfully.

### NOTE:

APs periodically send scheduled configuration requests to the controller, including the firmware version. Therefore, when an AP joins a zone for the first time, the firmware version is verified by the controller. If the firmware version is different from that which is configured for the zone, the controller responds with a request to upgrade it, after which the AP initiates a request to upgrade the firmware using HTTP.

The screenshot shows the 'Administration >> Upgrade' page. It includes a 'System Upgrade' section with a checkbox for 'Run Pre-Upgrade Validations' and a 'Browse' button for uploading a patch file. Below this is the 'Current System Information' table:

Current System Information		Patch for Pending Upgrade
Controller Version	3.4.0.0.855	Patch Version
AP Firmware Version	3.4.0.0.1135	

At the bottom, there is a 'System Upgrade History' table with the following data:

Start Time	System Version	AP Firmware Version	Path File Name	Upgrade Elapsed
2016/06/06 09:44:49	3.4.0.0.838->3.4.0.0.855	3.4.0.0.1114->3.4.0.0.1135	vscg-3.4.0.0.855.ximg	30m 16s
2016/06/01 09:50:15	3.4.0.0.704->3.4.0.0.838	3.4.0.99.961->3.4.0.0.1114	vscg-3.4.0.0.838.ximg	36m 31s
2016/04/25 18:13:08	3.4.0.0.677->3.4.0.0.704	3.4.0.99.924->3.4.0.99.961	vscg-3.4.0.0.704.ximg	27m 3s
2016/04/25 11:19:13	3.4.0.0.677	3.4.0.99.924	Fresh Installation	19m 17s

Figure 227: Check the value for Controller Version

## Rolling Back to a Previous Software Version

There are two scenarios in which you may want to roll back the controller software to a previous version:

1. You encounter issues during the software upgrade process and the controller cannot be upgraded successfully. In this scenario, you can only perform the software rollback from the **CLI** using the restore local command. If you have a two-node controller cluster, run the restore local command on each of the nodes to restore them to the previous software before attempting to upgrade them again.
2. You prefer a previous software version to the newer version to which you have upgraded successfully. For example, you feel that the controller does not operate normally after you

upgraded to the newer version and you want to restore the previous software version, which was more stable. In this scenario, you can perform the software rollback either from the web interface or the **CLI**. If you have a two-node controller cluster, you must have cluster backup on both of the nodes.

To ensure that you will be able to roll back to a previous version, Ruckus Wireless® strongly recommends the following before attempting to upgrade the controller software:

- Always back up the controller before attempting a software upgrade. If you are managing a multi-node cluster, back up the entire cluster, and then verify that the backup process completes successfully. See [Creating a Cluster Backup](#) on page 341 for the local backup instructions. If you have a local backup and you want to roll back the controller to a previous software version, follow the same procedure described in [Restoring a Cluster Backup](#) on page 342.
- If you have an FTP server, back up the entire cluster and upload the backup files from all the nodes in a cluster to a remote FTP server. See [Backing Up to an FTP Server](#) on page 345 for remote backup instructions and [Restoring from an FTP Server](#) on page 347 for remote restore instructions.

## Recovering a Cluster from an Unsuccessful Upgrade

If an issue occurs during the upgrade process (for example, a power outage occurs or one of the interfaces goes down), you can recover the cluster if the controller has either a local cluster backup or a remote (FTP) configuration backup.

### If the Controller Has Local Cluster Backup

Follow these steps to recover a cluster when the controller has a cluster backup stored locally.

1. Unplug the cluster interface cables of each node in the cluster to isolate each individual node.
2. On each of the nodes in the cluster, perform the following:
  - a) Log on to the **CLI**, and then execute `restore local`.

#### NOTE:

Issue the `restore local` command at the same time for both nodes, or temporarily disconnect the cluster interface and issue the command. After issuing the command, connect the cluster interface back.

This command will restore the system configuration of the node from a local backup.

- b) When the **CLI** indicates that the `restore local` command has been completed successfully, plug in the cluster interface cable.

You have completed recovering the controller cluster using a local cluster backup.

### If the Controller Has an FTP Backup

Follow these steps to recover a cluster when the controller has a configuration backup on a remote FTP server.

See [Backing Up to an FTP Server](#) on page 345 for more information.

You must perform steps on each of the nodes in the cluster.

1. Log on to the **CLI** of each of the nodes.
2. Execute the `set-factory` command to reset the node to factory settings.

**NOTE:** See [Resetting a Node to Factory Settings](#) on page 358 for more information.

3. Using the **CLI**, set up the controller as a standalone unit.
4. Copy the cluster configuration backup from the FTP server to the controller.
5. Execute the `restore local` command from the **CLI**.

**NOTE:**

Issue the `restore local` command at the same time for both nodes, or temporarily disconnect the cluster interface and issue the command. After issuing the command, connect the cluster interface back.

6. When the **CLI** indicates that the `restore local` command has been completed successfully, plug in the cluster interface cable.

Repeat the same procedure until you have restore the cluster configuration backup from the FTP server to all of the nodes in the cluster.

You have completed recovering the controller cluster using an FTP backup.

## Uploading AP Patch Files

New AP models and firmware updates are supported without the need to upgrade the controller image by using the AP patch files supplied by Ruckus Wireless.

Follow these steps to upload the patch file:

1. Go to **Administration > Upload AP Patch**.

The **Upload AP Patch** page is displayed.

2. Click **Browse** to select the patch file (with extension `.patch`).
3. Click **Open**.
4. Click **Upload**.

After the patch files is updated, the **AP Patch Information** section is populated with the following information:

- Name of the patch file
- Size of the patch file
- AP firmware version number
- AP model number

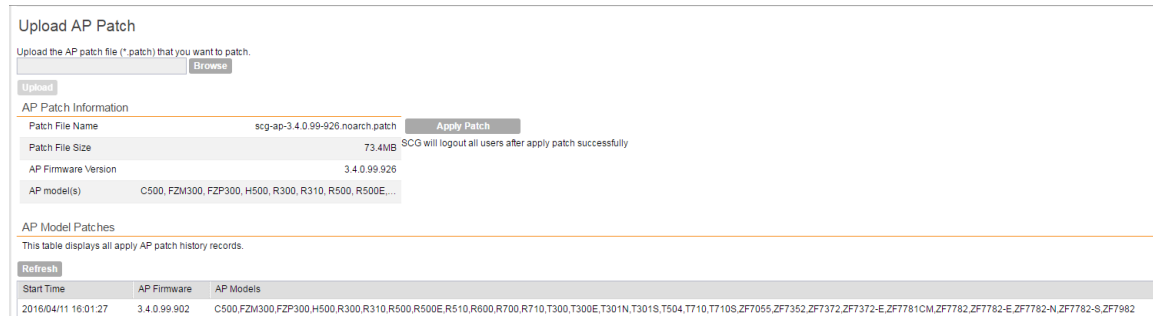
5. Click **Apply Patch** to apply the patch file to the AP model or firmware as appropriate.

The **AP Model Patched** section displays all the AP models and AP firmware that were updated by the patch file.

**NOTE:** You will be prompted to log out after this step.

You have successfully updated the AP models and AP firmware with the patch file, without having to upgrade the controller software.

**Figure 228: Uploading AP patch files**



## Working with Logs

This section describes the logs that are available in the controller and how to download them.

### Available System Log Types

The controller generates logs for all the applications that are running on the server.

The following table lists the controller applications that are running.

**Table 22: Controller applications and log types (Continued)**

Application	Description
AIP	Handles the accounting messages for TTG sessions
CaptivePortal	Performs portal redirect for clients and manages the walled garden and blacklist
Cassandra	The controller's database server that stores most of the run-time information and statistical data
CIP	The <i>Charging Interface</i> module, which handles the <i>Ga</i> interface towards CGF server
CNR	An application that obtains TTG configuration updates and applies the settings to related modules
Communicator	Communicates with access points and retrieves statuses, statistics, and configuration updates
Configurer	Performs configuration synchronization and cluster operations (for example, join, remove, upgrade, backup, and restore)
DBlade	The data plane application and data core logs are sent to the control plane through the syslog. DBlade lists the logs on the control plane.

Application	Description
DHCPServer	The DHCP server in the SCG-C TTG module receives DHCP messages from DHCP relay in d-blade
DiaAuthProcess	Uses the STa/Gx interface for authentication through the Diameter Protocol.
Diagnostics	An interface that can be use to upload Ruckus Wireless scripts (.ksp files) for troubleshooting or applying software patches. This interface displays the diagnostic scripts and system patch scripts that are uploaded to a node.
EAuth	Manages the sessions on the SCG-C TTG module
EventReader	Receives event messages from access points and saves the information into the database
Greyhound	The interface between the SCG-C TTG module and the AP interface, used to send and receive proprietary messages for AP association and disassociation
HIP	Module with SIGTRAN stack and interface to operator HLR(s)
LogMgr	Organizes the Application Logs into a common format, segregates them, and copies them into the respective Application log file
MdProxy	MdProxy on AP and SCG connect to AP-MD and SCG-MD respectively. MdProxy on SCG receives messages and retrieves the message header. It also forwards the response to SCG-MD. This message is sent to the MdProxy on AP through AP-MD. MdProxy on the AP removes the MSL header and responds to the connection on which the request was received.
Memcached	The controller's memory cache that stores client authentication information for fast authentication or roaming
MemProxy	Replicates MemCached entries to other cluster nodes
Monitor	Monitors the health of cluster processes and communicates cluster state changes to the cluster node
Mosquitto	A lightweight method used to carry out messaging between LBS and APs
Mqttclient	A lightweight client used to communicated with the MQTT server using methods that block intrusion until an operation completes.
MsgDist	The Message distributor (MD) maintains a list of communication points for both local applications and remote MDs to perform local and remote routing
NC	The Node Controller, which monitors all SCG-C TTG processes
NginX	Is a web server that is used as a reserve proxy server or a HTTP cache



Application	Description
Northbound	As an interface between SP and AAA, it performs UE authentication and handles approval or denial of UEs to AP.
OnlineSignup	A standard and secured method to access devices in a WPA2 hotspot network
PMIPv6d	Handles UE Session Context details for PMIP calls
RadiusProxy	Sets the RADIUS dispatch rules and synchronizes configuration to each cluster node
Scheduler	Performs task scheduling and aggregates statistical data
SNMP	Provides a framework for the monitoring devices on a network. The SNMP manager is the system is used to control and monitor the activities of network hosts using SNMP. As an agent that responds to queries from the SNMP Manager, SNMP Traps with relevant details are sent to the SNMP Manager when configured.
SubscriberManagement	Maintains local user credentials for WISPr authentication.
SubscriberPortal	Internal portal page for WISPr (hotspot)
System	Collects and sends log information from all processes
Web	Runs the controller management web server

## Downloading All Logs

Follow these steps to download all available logs from the controller.

1. Go to **Administration > Diagnostics**.
2. On the sidebar, click **Application Logs & Status**.
3. In **Select Control Plane**, select the control plane from which you want to download logs.
4. Click the **Download All Logs** button.

Your web browser downloads the logs in GZIP Compressed Tar Archive (with `.TGZ` extension) to its default download location.

5. Go to your web browsers default download location and verify that the TGZ file was downloaded successfully.
6. Use your preferred compression/decompression program to extract the log files from the TGZ file.
7. When the log files are extracted (for example, `adminweb.log`, `cassandra.log`, `communicator.log`, etc.), use a text editor to open and view the log contents.

You have completed downloading all the controller logs.

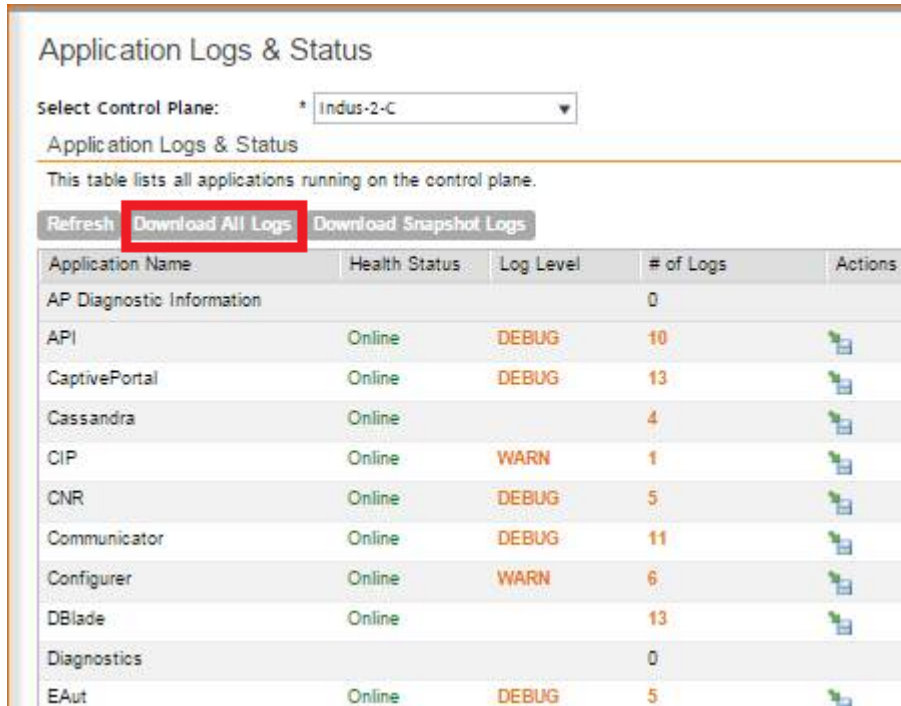


Figure 229: Click the Download All Logs button

### Downloading Snapshot Logs Generated from the CLI

Snapshot logs contain system and configuration information, such as the AP list, configurations settings, event list, communicator logs, SSH tunnel lists, etc. If you triggered the controller to generate a snapshot from the **CLI**, you have the option to download snapshot logs from the web interface.

Follow these steps to download the CLI-generated snapshot logs from the web interface.

1. On the **CLI**, trigger the controller to generate a snapshot.
2. Log on to the web interface.
3. Go to **Administration > Diagnostics**.
4. On the sidebar, click **Application Logs & Status**.
5. Click **Download Snapshot Logs**.

Your web browser downloads a tar (.TGZ) file that contains all available snapshot logs.

6. Go to your browser's default download folder, and then verify that the snapshot log file or files have been downloaded successfully.
7. Extract the contents of the tar file.

You have completed downloading snapshot logs from the controller.

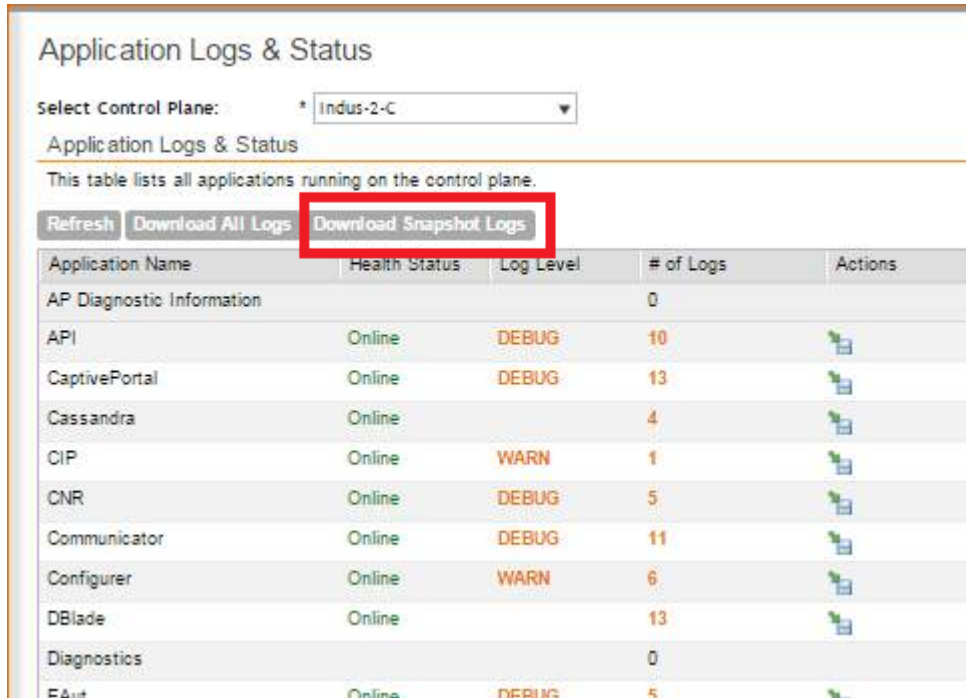


Figure 230: Click Download Snapshot Logs to download all available snapshot logs

## Managing AP Certificate Replacement

AP certificates are valid for a period of time and have to be replaced when they expire. Certificates installed on Ruckus APs manufactured prior to 2014 require a certificate refresh before November 2016 to avoid service interruption.

**There is no operational impact to the system before November 2016.**

You will also see the following warning message on the dashboard of the web interface: `***The 90-day temporary AP license for this system will expire on 2016-02-06. Add an AP capacity license to avoid interruption to service.***`

Reminder: Some of your APs need to have their Certificate replaced by November 2016. Until then those APs will continue to operate as-is with NO OPERATIONAL impact. You may go to Administration>AP Certificate Replacement and follow the Refresh Process any time before November 2016.

Please visit <https://support.ruckuswireless.com/certificate> for details.

The system generates an `apCertificateExpireSystem` alarm and event when an AP certificate expires.

To renew the AP certificate, you must perform the following tasks (listed in order):

1. [Viewing AP Certificate Status](#) on page 372.
2. [Exporting AP Certificate Requests](#) on page 372

3. [Exporting AP Certificate Requests](#) on page 372
4. [Importing AP Certificate Responses](#) on page 375
5. [Confirming AP Certification Status](#) on page 378

## Viewing AP Certificate Status

You can view a certificate for a new AP that is managed by the controller.

1. Go to **Administration > AP Certificate Replacement**.

The **AP Certificate Replacement** page appears.

**Figure 231: AP Certificate Replacement**

Update Successfully:0  
Update Pending:4  
Updating:0  
Update Failed:0

Request Status ⊕

View a list of AP which needs to update its certificate

Refresh Export Import Search terms:  x  Include all terms  Include any of these terms

AP Name ▲	Description	Model	Serial Number	Need Export
H500		H500	471484500082	Yes
RuckusAP		T300	511484914470	Yes
RuckusAP		T301S	501434903517	Yes
RuckusAP		ZF7982	301303001725	Yes

Show 10 << | 1 | >> 4 total records

Certificate Status ⊕

View a list of AP which certificate is updating or update failed

Refresh Reset Update Failed AP Search terms:  x  Include all terms  Include any of these terms

AP Name ▲	Description	Model	Serial Number	Status
-----------	-------------	-------	---------------	--------

You can also view the list of APs by zone in SCG200 devices running release 3.4.1 and later.

2. In **Request Status** section, view the list of APs which need a certification update.
3. In **Certificate Status** section, view the status of the certification update from the **Status** column.

## Exporting AP Certificate Requests

You can export certificate requests for a new AP that is managed by the controller.

Follow these steps to export AP certificate requests.

1. Go to **Administration > AP Certificate Replacement**.

The **AP Certificate Replacement** page appears. You can view the status of the certification update for the APs as shown in the figure.

**Figure 232: AP Certificate Replacement**

Update Successfully:0  
Update Pending:11  
Updating:1  
Update Failed:0

Request Status 🔔

View a list of AP which needs to update its certificate

Refresh **Export** Import Search terms:   Include all terms  Include any of these terms

AP Name	Description	Model	Serial Number	Need Export
7372	New APs	ZF7372	981202006307	Yes
Cert-R500		R500	911574907470	No
R500		R500	481444406712	Yes
RuckusAP		T300	181564407093	Yes
RuckusAP		R500	911584410314	Yes
RuckusAP		H500	371406000036	Yes
RuckusAP		T300E	311494301508	Yes
RuckusAP		ZF7982	431303001475	Yes

2. In **Request Status**, view the list of APs.

APs that have already exported the certificate request are marked **No** and the ones which need to export the certificate request are marked **Yes**.

**NOTE:** Use the Search terms option to look for APs by name, model, serial number, or description.

3. From **Export**, select one of the following:

- **All APs:** to export the certificates for all the APs.
- **New APs:** to export the certificates for new APs or APs that need to regenerate the certificates.

4. Click **OK** to export the file and copy it to your local drive.

**NOTE:** All exported AP Certificate request (.req) files generated from a cluster include it's name. To manage multiple export request files, change the filename before uploading it to uniquely identify the file.

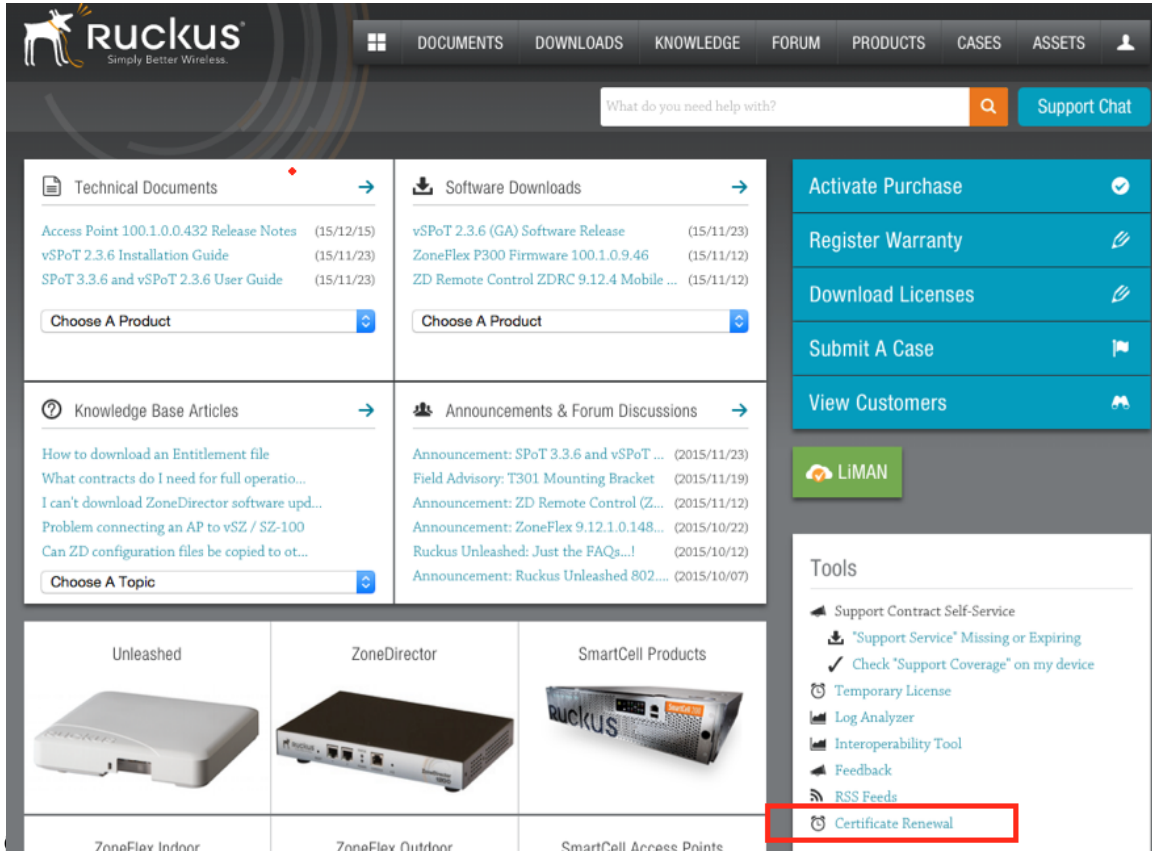
For example: cert-scg-cluster5f6433ef-711b-4f44-b38a-ddd485ee2c37-**R500**.req

You have successfully exported the AP certificate request file.

## Requesting AP Certificate Renewal

1. Login to <https://support.ruckuswireless.com/> with your credentials and click **Certificate Renewal** under **Tools** as shown in the figure.

Figure 233: AP certificate



The Certificate Renewal request page appears.

2. Click **Browse** to select the **.req** file exported from **Certificate Refresh** page.
3. Enter the e-mail address for communication.
4. Click **Upload**.

You will receive an e-mail acknowledgment from Ruckus Wireless as shown in the figure.

**Dear Valued Customer,**

**Request is received for certificate renewal.**

**The request is under process for CR-000183.**

**We will get back to you with subsequent steps as soon as the process is complete.**

**Regards,  
Ruckus Team**

Figure 234: Sample e-mail acknowledgment

- View the status of your request from the **Certificate Renewal Request** page as shown.

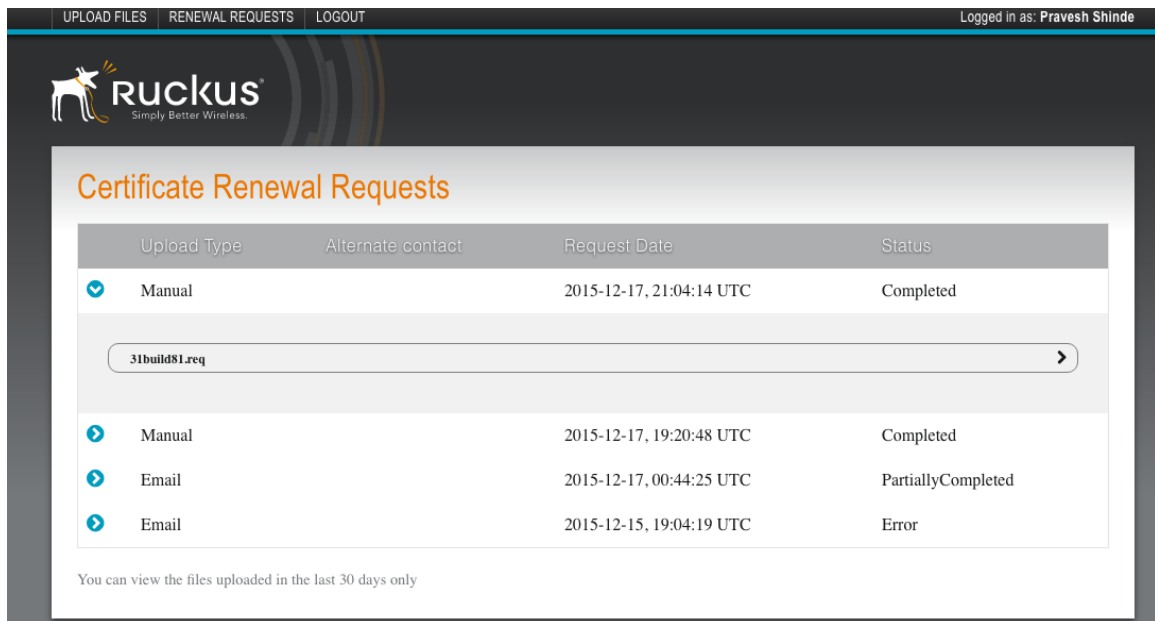


Figure 235: Certificate Renewal Request page

- After the request is processed, you will receive the following response from Ruckus Wireless, with a link to the **.res** response file for Import on the **Certificate Refresh** page.

Dear Valued Customer,

Thank you for purchasing Ruckus Wireless License(s).

Below is a list of licenses related to CR-000157. Click on link in the table below.

File will be available for download until next 30 days. Please download file within next 30 days.

Req File Name	Activation Link
31build81.req	<a href="#">31build81.res</a>

Regards,  
Ruckus Team.

Figure 236: Sample e-mail confirmation from Ruckus Wireless

## Importing AP Certificate Responses

You can replace an AP certificate by importing a new certificate.

APs requiring new certificates that are included in the request file **will reboot** after Step 5 (described below) is completed.

Consider using a staged approach to import the response files. Use the **Search terms** option to look for APs by name, model, serial number, or description, for larger WiFi networks to minimize service interruption.

1. Go to **Administration > AP Certificate Replacement**.  
The **AP Certificate Replacement** page appears.
2. In **Request Status** section, select the AP response file for import.
3. Click **Import**.

The **Import AP certificates for replacement** screen appears as shown in the figure.

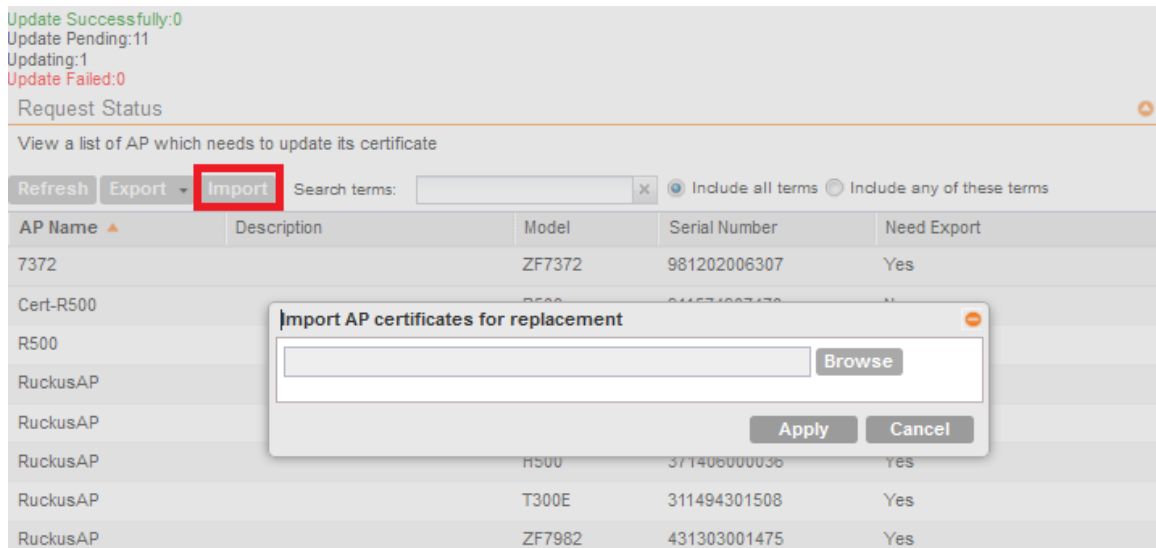


Figure 237: Importing AP certificates

4. Click **Browse**, and select the certificate file.
5. Click **Apply** to import the new certificate to the AP.

**NOTE:** All APs included in the imported response (.res) file **reboot** after their certificate is refreshed.

The **Update Successfully** counter displays the APs for which certificate refresh was successful, and the **Certificate Status** section displays APs for which certificate refresh is in progress or have failed. You can also view other AP certificate refresh statuses from the **Updating**, **Update Pending** and **Update Failed** counters.



Administration >> AP Certificate Replacement

### AP Certificate Replacement

1.Export AP Certificate Replacement Request (.req) file .  
 2.Login to <https://support.ruckuswireless.com/> .  
 3.Select AP Certificate Replacement under Tools .  
 & At <https://certrenewal.ruckuswireless.com/> , provide return email address and Upload .req export file .  
 4.Email recipient will receive the AP certificate Response (.res) file to Import .  
 5.For further information, please refer to <https://support.ruckuswireless.com/certificate> .  
 Note:AP will restart after its certificate replaced

Update Successfully:0  
 Update Pending:0  
 Updating:5  
 Update Failed:0

#### Request Status

View a list of AP which needs to update its certificate

Refresh Export Import Search terms:  X  Include all terms  Include any of these terms

AP Name ▲	Description	Model	Serial Number	Need Export
No data				

Show 10 << | 1 | >>

#### Certificate Status

View a list of AP which certificate is updating or update failed

Refresh Reset Update Failed AP Search terms:  X  Include all terms  Include any of these terms

AP Name ▲	Description	Model	Serial Number	Status
7982		ZF7982	301303002585	Updating
RuckusAP		R600	431503405715	Updating
RuckusAP		ZF7372	991542101396	Updating
RuckusAP		T300	121406000107	Updating
RuckusAP		R300	971402011322	Updating
RuckusAP		ZF7782-S	211304011566	Updating

Show 10 << | 1 | >> 6 total records

Figure 238: The number after "Updating" indicates the number of APs on which the certificate is being updated

**RUCKUS**

Dashboard Monitor Configuration

Administration >> AP Certificate Replacement

### AP Certificate Replacement

- 1 Export AP Certificate Replacement Request (.req) file .
- 2 Login to <https://support.ruckuswireless.com/> .
- 3 Select AP Certificate Replacement under Tools .
  - a. At <https://certrenewal.ruckuswireless.com/> , provide return email address and Upload .req export file .
- 4 Email recipient will receive the AP certificate Response (.res) file to import .
- 5 For further information, please refer to <https://support.ruckuswireless.com/certificate> .

Note: AP will restart after its certificate replaced

Update Successfully: 6  
Update Pending: 0  
Updating: 0  
Update Failed: 0

**Request Status**

View a list of AP which needs to update its certificate

Refresh Export Import Search terms: [ ] Include all terms Include any of these terms

AP Name	Description	Model	Serial Number	Need Export
No data				

Show 10 << | 1 | >>

**Certificate Status**

View a list of AP which certificate is updating or update failed

Refresh Reset Update Failed AP Search terms: [ ] Include all terms Include any of these terms

AP Name	Description	Model	Serial Number	Status
No data				

Show 10 << | 1 | >>

Figure 239: The number after "Update Successfully" indicates the number of APs on which the certificate was updated successfully

There is no operational impact to the system before November 2016, even if AP certificate refresh fails.

You have successfully imported the certificate to the AP.

### Confirming AP Certification Status

1. Go to **Administration > AP Certificate Replacement**.

The **AP Certificate Replacement** page appears

2. In **Certificate Status** section, view the status of the certification update from the **Status** column.

**Certificate Status**

View a list of AP which certificate is updating or update failed

Refresh Reset Update Failed AP Search terms: [ ] Include all terms Include any of these terms

AP Name	Description	Model	Serial Number	Status
7372-szm		ZF7372	981202006307	Update Failed
RuckusAP		ZF7321-U	371203001034	Updating

Show 10 << | 1 | >> 2 total records

Figure 240: Certificate status

If the AP is updating, the status displayed against the AP is **Updating**. If the AP certificate does not update, the status displayed against the AP is **Update Failed**.

**NOTE:** The AP reports to the controller at 15-minute intervals. As a result, it may take up to 15 minutes for the AP to update its certificate status on the web interface.

- Click **Request Updated Failed AP** to reset the status of the APs for which certification update failed.

After reset, the status of the AP in the **Request Status** section change. APs in need of a new certificate display **Yes** in the **Need Export** column.

**Figure 241: APs requiring new**

Update Successfully:0  
Update Pending:11  
Updating:1  
Update Failed:0

Request Status ⓘ

View a list of AP which needs to update its certificate

Refresh **Export** Import Search terms:   Include all terms  Include any of these terms

AP Name	Description	Model	Serial Number	Need Export
7372	New APs	ZF7372	981202006307	Yes
Cert-R500		R500	911574907470	No
R500		R500	481444406712	Yes
RuckusAP		T300	181564407093	Yes
RuckusAP		R500	911584410314	Yes
RuckusAP		H500	371406000036	Yes
RuckusAP		T300E	311494301508	Yes
RuckusAP		ZF7982	431303001475	Yes

Use the **Search terms** option to look for APs by name, model, serial number, or description.

## Managing Licenses

Depending on the number of Ruckus Wireless APs that you need to manage with the controller, you may need to upgrade the controller license as your network expands.

The maximum number of access points that the controller can manage is controlled by the license file that came with the controller. If the number of access points on the network exceeds the limit in the license file, you will need to obtain an additional license file and upload it to the controller.

**NOTE:** For information on obtaining additional license files, contact Ruckus Wireless Support or an authorized Ruckus Wireless reseller.

The maximum number of access points that a license supports depends on its stock-keeping unit (SKU).

## Default Licenses

SCG-200 comes embedded with default licenses to enable you to manage a limited number of APs right out of the box without having to register or purchase add-on licenses.

**Table 23: SCG-200 Default licenses**

License Type	Number	Validity
Default AP License	10000	90 days
Default Direct tunnel license	10000	90 days
Default 3rd-Party AP Client License	100000	90 days
Default 3GPP Tunnel License	100000	90 days
Default Feature License to enable HLR	1	90 days
Default SCG 200 Support License	1	90 days

### Default AP Capacity License

The default AP capacity license (CAPACITY-AP-DEFAULT) is same as the AP capacity license. This license, however, is embedded into the controller and is non-transferable. The default AP capacity license allows you to manage up to 50 APs using the controller.

### Default AP Tunneling Capacity License

The default AP tunneling capacity license (CAPACITY-RXGW-DEFAULT) is the same as the AP tunneling capacity license. This license, however, is embedded into the controller and is non-transferable. The default AP tunneling capacity license allows you to manage up to 10,0001000 APs with SoftGRE capability.

### Default Third Party AP Client License

The default third-party AP client license (CAPACITY-RWAG-DEFAULT) is a subscriber-based license which controls the number of concurrent subscriber/client/UE data traffic attached to third-party Wi-Fi APs. This license allows you to manage up to 100,000 APs using the controller.

### Default 3GPP Tunnel License

The default 3GPP tunnel license is a subscriber-based license which controls the number of concurrent subscriber/client/UE traffic attached over Ruckus APs, or over third-party Wi-Fi APs requiring traffic tunneling to a 3GPP (GGSN or LTE PGW) element. This license allows you to manage up to 100,000 APs using the controller.

### Default Feature License to Enable HLR

The default feature license to enable HLR (FEATURE-RMAP-DEFAULT) enables user authentication using the SIGTRAN protocol, which signals to an external HLR. This license allows you to manage one AP using the controller.

### Default Support License

The default support license (SUPPORT-EU-DEFAULT)default SCG 200 support license (SUP-SCG200-EU-DEFAULT) is same as the end user support license, but with a 90-day

expiration time. This license is embedded into the controller and is non-transferable. The controller comes with one default support license.

## Viewing Installed Licenses

You can view the details of all the licenses that you have uploaded to the controller.

The following table lists the different columns that appear in the **Installed Licenses** section.

**Table 24: Information in the Installed License section**

Column Name	Description
Node	The name of the node to which the license was uploaded
Feature	The stock-keeping unit (SKU) code of the license file
Capacity	The number of units or license seats that the license file provides
Description	The type of license
Start Date	The date when the license file was activated
Expiration Date	For time-bound licenses, this column shows the date when the license file expires. For permanent licenses, this column shows <code>Permanent</code>

Installed Licenses  
This table shows the currently installed licenses.

Refresh Search terms:  x  Include all terms  Include any of these terms

Node	Feature	Capacity	Description	Start Date	Expiration Date
VSCG34	SUPPORT-EU-DEFAULT	1	Default End User Support License for vSZ	2016/04/25	2016/07/24
VSCG34	INSTANCE-VSCG-DEFAULT	1	Default Instance License for vSZ	2016/04/25	2016/07/24
VSCG34	CAPACITY-VSZD-DEFAULT	2	Default vSZ-D Capacity License	2016/04/25	2016/07/24
VSCG34	CAPACITY-RXGW-DEFAULT	4	Default AP Direct Tunnel License for vSZ	2016/04/25	2016/07/24
VSCG34	CAPACITY-AP-DEFAULT	4	Default AP Capacity License for vSZ	2016/04/25	2016/07/24
VSCG34	CAPACITY-RXGW-DEFAULT	1	Default AP Direct Tunnel License for vSZ		Permanent
VSCG34	CAPACITY-AP-DEFAULT	1	Default AP Capacity License for vSZ		Permanent

**Figure 242: The Installed Licenses section**

## Viewing License Summary

You can view a summary of total, consumed, and available licenses for the different license types.

The following table lists the different columns that appear in the **License Summary** section.

**Table 25: Information in the License Summary section**

Column Name	Description
License Type	The type of license file
Total	The maximum number of access points that can be supported by all the licenses that have been uploaded to the controller.

Column Name	Description
Consumed	The number of license seats that have been used. One access point uses up one license seat. For example, if three access points have registered with the controller, the Consumed field will show 3.
Available	The number of license seats remaining. For example, if all your licenses support up to 5000 access points, and the controller has used up three licenses so far, the Available field will show 4997.

#### License Summary

This table shows total units, consumed units and available units for each license type.

License Type	Total	Consumed	Available
AP Capacity License	5	1 (20%)	4 (80%)
AP Direct Tunnel license	5	0 (0%)	5 (100%)
vSZ-D Capacity License	2	0 (0%)	2 (100%)

Figure 243: The License Summary section

## Configuring the License Server

Ruckus Wireless provides two options for managing the licenses that you have purchased for the controller:

**Cloud License Server** Also known as the SmartLicense server, this a cloud-based server that stores all of the licenses and support entitlements that you have purchased for the controller. For information on how to set up and activate your SmartLicense account, see the *SmartLicense User Guide*.

**Local License Server (LLS)** This is a license server that is installed onsite where the controller is deployed. For information on how to obtain and set up the LLS server, see the *SmartCell Gateway Local Licensing Server User Guide*.

Follow these steps to select a license server that the controller will use.

**1. Go to Administration > Licenses.**

The **License Management** page appears.

**2. In License Server Configuration, select one of the following:**

Option	Description
<b>Cloud License Server</b>	Select this option to use the Ruckus Wireless SmartLicense server.
<b>Local License Server</b>	Select this option to use an LLS that you have set up on the network, and then configure the following: <ul style="list-style-type: none"> <li>• <b>Domain or IP:</b> Type the FQDN or IP address of the LLS.</li> <li>• <b>Port:</b> Type the port number. Port range is from 0 to 65535 (default is 3333).</li> </ul>

3. Click **Apply**.  
A confirmation message appears.
4. Click **Yes**.  
The controller saves the selected license server configuration, deletes all of its saved license data, and then automatically synchronizing the license information with the selected license server.

You have completed configuring the license server that the controller will use.

#### License Server Configuration



The screenshot shows a configuration window titled "License Server Configuration". It has two radio buttons: "Cloud License Server" (unselected) and "Local License Server" (selected). To the right of the "Local License Server" option are two input fields. The first is labeled "Domain or IP:" and contains the text "172.19.16.25". The second is labeled "Port:" and contains the text "3333". At the bottom left of the window are two buttons: "Apply" and "Cancel".

Figure 244: The License Server Configuration section

### Importing License Files

If the controller is disconnected from the Internet or is otherwise unable to communicate with the Ruckus Wireless SmartLicense system (due to firewall policies, etc.), you can manually import a license entitlement file into the controller.

**NOTE:** The option to import a license file manually into the controller is only available if the controller is using the cloud license server.

Follow these steps to import a license file into the controller.

1. Obtain the license file.  
You can do this by logging on to your Ruckus Wireless Support account, going to the license management page, and then downloading the license file (the license file is in `.bin` format).
2. Log on to the controller web interface, and then go to **Administration > License**.
3. In **Select Controller** under **Upload License**, select the node for which you are uploading the license file.
4. In **Select License File**, click **Browse**, locate the license file (`.bin` file) that you downloaded from your Ruckus Wireless Support account, and then select it.
5. Click **Upload**.  
The page refreshes, and the information in the **Installed Licenses** section changes to reflect the updated information imported from the SmartLicense platform.

You have completed importing a license file manually.

## Manual License Management

The screenshot shows two sections of a web interface for license management. The top section, titled "Upload License", contains a dropdown menu for "Select a Controller:" with "VSCG34" selected, a text input field for "Select License File:" with a "Browse" button, and "Upload" and "Cancel" buttons. The bottom section, titled "Download License", contains a dropdown menu for "Select a Controller:" with "VSCG34" selected and "Download" and "Cancel" buttons.

Figure 245: The Upload License section

### Downloading Licenses

If you need to release licenses bound to an offline controller and allow those licenses to be used elsewhere (on a different controller), you can download a copy of the controller licenses.

The option to download a copy of the controller licenses is only available if the controller is using the Ruckus Wireless cloud license server.

Follow these steps to download a binary copy of the license files.

1. Go to **Administration > License**.
2. In **License Server Configuration**, verify that **Cloud License Server** is selected.
3. Locate the **Download License** section.
4. In **Select Controller**, select the controller node for which you want to download the license files.
5. Click **Download**.  
Your web browser downloads the license files from the controller.
6. When the download is complete, go to the default download folder that you have configured for your web browser, and then verify that the binary copy of the license files (with `.bin` extension) exists.

You have completed downloading copies of the controller licenses.



## Manual License Management

The screenshot displays two sections for license management. The top section, titled "Upload License", contains a dropdown menu for "Select a Controller:" with "VSCG34" selected, a text input field for "Select License File:" with a "Browse" button, and "Upload" and "Cancel" buttons. The bottom section, titled "Download License", contains a dropdown menu for "Select a Controller:" with "VSCG34" selected and "Download" and "Cancel" buttons. The "Download License" section is highlighted with a red border.

Figure 246: The Download License section

### Synchronizing Controller with the License Server

By default, the controller automatically synchronizes its license data with the selected license server every 24 hours. If you made changes to the controller licenses (for example, you purchased additional licenses) and you want the controller to download the updated license data immediately, you can trigger a manual synchronization.

Follow these steps to trigger the controller to manually synchronize with the license server.

1. Go to **Administration > License**.
2. Click **Sync Now**.

The message `Start sync with license server...` appears as the controller synchronizes its license data with the server.

When the sync process is complete, the message `Sync license with the license server successful` appears. If the previously saved license data are different the latest license data on the server, the information in the **Installed Licenses** section refreshes to reflect the latest data.

You have completed manually synchronizing the controller with the license server.

---

## Appendix

# A

---

## Overview of the Captive Portal

In this chapter:

- [Configuring the Captive Portal](#)
- [Captive Portal Workflows and VSA](#)

The controller supports tunneling of captive portal user traffic to the 3G/4G/5G core network. During hotspot authentication, the controller either routes user traffic to the packet core or directly breaks the traffic out to the Internet, depending on authentication method used by the UE.

Users who are authenticating via the 802.1x method can either be routed to the GGSN or through local breakout to Internet based on certain configurations. For users authenticated via captive portal, integration with packet core is not supported and traffic is always routed to Internet from the controller.

By routing traffic directly to the Internet, the operator loses control and visibility over Wi-Fi traffic. Since the controller does not support Policy and Charging Rule Function (PCRF) integration for retrieving policy for user and LI integration, QoS and LI cannot be applied to traffic that is directly routed to the Internet.

Smart Wi-Fi system is an enhancement that allows user traffic integration with GGSN for user authentication via a captive portal. Multiple schemes are supported for captive portal based authentication, such as:

- User name and password
- Voucher
- One-time password based on MSISDN
- Creating virtual account and adding credits

Smart Wi-Fi System allows packet core integration for all users irrespective of the authentication scheme used. Decision to either integrate user traffic to packet core or directly to Internet is based on the configuration setup.

To establish data traffic tunnel to core network (GGSN/PGW), the controller receives associated IMSI and MSISDN user identities from the AAA server preconfigured with the required credentials to map following identifiers:

- User name
- MAC address
- IMSI value
- MSISDN value

When the user accesses the controller's WLAN through the captive portal registration, it interfaces with the AAA server to register the user device's MAC address. Upon successful authentication, the captive portal disassociates the user and re-associates it with the controller's WLAN using the registered device MAC address. This functionality is supported as part of the MAC bypass feature with Ruckus Wireless APs.

When a user reconnects to a WLAN, the Ruckus Wireless AP triggers MAC-based authentication. Upon a successful authentication, the AAA server returns the associated identifiers of IMSI and MSISDN along with the flag (Ruckus VSA - see: [Captive Portal Workflows and VSA](#) on page 401) indicating that the TTG tunnel is established. The controller returns the TTG session type to the AP used by the data plane to trigger the TTG establishment when DHCP DISCOVER is received.

## Configuring the Captive Portal

This section describes the configuration procedures required to set up the captive portal.

### Configuring the GGSN/PGW Service

The controller has 3GPP-defined Tunnel Terminating Gateway (TTG) functionality, which enables it to act as a gateway between the UE (southbound) and the telecom core (northbound) to tunnel traffic between the UE (User Equipment, such as mobile phones) and controller gateway terminates the tunnel and then transfers the data over to GGSN (Gateway GPRS Serving Node) implementing the Gn interface via GTPv1 (Release 6).

The Gn interface is used in controlling the signal between controller and GGSN as well as for tunneling end user data payload within the backbone network between both the nodes.

GPRS Tunneling Protocol (GTP) transmits user data packets and signaling between controller and GGSN. GTP encapsulates traffic and creates GTP tunnels, which act as virtual data channels for transmission of packet data between controller and GGSN. A GTP tunnel is established between controller and GGSN for a data session initiated from UE.

A GTP tunnel is identified by a pair of IP addresses and a pair of GTP Tunnel End Point Identifiers (TEIDs), where one IP address and TEID is for the SGSN and the other is for GGSN. TEID is a session identifier used by GTP protocol entities in SGSN and GGSN.

GTP separates signaling from payload. Traffic is sorted onto a control plane (GTP-C) for signaling and a user plane (GTP-U) for user data. GTP-C is a tunnel control and management protocol and is used to create, modify and delete tunnels. GTP-U is a tunneling mechanism that provides a service for carrying user data packets.

Clicking **Configuration > Services & Profiles** on the main menu displays a sidebar on the left side of the page, which includes GGSN Services. [Figure 247: The GGSN/PGW Services configuration page](#) on page 388 shows the GGSN Service configuration page.

### GGSN/PGW

**GTP Common Configuration**

Response Timer (2-5 Seconds): \* 3

Number of Retries (N3 3-6): \* 5

Echo Request Timer (60-300 Seconds): \* 60

DNS Response Timeout (secs): \* 3

DNS # of Retry: \* 3

---

**DNS Servers**

IP Add Server

---

**APN Resolution**

Create New Delete Selected

<input type="checkbox"/> Domain Name ▲	IP	Actions
<input type="checkbox"/> ruckus.com	10.1.13.19	

Refresh Apply Cancel

**Figure 247: The GGSN/PGW Services configuration page**

Follow these steps to configure the GGSN/PGW service.

1. Go to **Configuration > Services & Profiles**.
2. On the sidebar (under **Services**), click **GGSN/PGW**.
3. In the **GTP Common Configuration** section, configure the following options:
  - **Response Timer:** Define the response expected from GGSN server from the drop down list, which ranges from 2 to 5 seconds. The controller will attempt to contact the GGSN during call establishment.
  - **Number of Retries:** Define the number of times that controller will attempt to contact the GGSN. If all attempts fail, the relevant alarm is raised to confirm the failure of the GGSN path. For example, if the response timer is 3 and the number of retries is 5, it means that for each retry, controller will for 3 seconds.
  - **Echo Request Timer:** Define number of seconds that the GGSN waits before sending an echo-request message to check for GTP path failure.
  - **DNS Response Time:** Specify the maximum time that DNS waits for a response from a signaling request message.
  - **DNS # Retry:** specify the maximum number of times that the DNS attempts to send a signaling request.
4. In the **DNS Servers** section, click **Add Server** to add a DNS IP address.

If you're adding multiple DNS IP addresses, you can set their priority by clicking the **Move Up** and **Move Down** buttons. DNS servers that are higher up on the list of servers are given higher priority.
5. In the **APN Resolution** section, click **Create New** to define the IP address of the GGSN that should serve the AP.
6. Configure the following options:

- **Domain Name:** Type the GGSN domain name.
- **IP Address:** Type the GGSN IP address.

7. Click **Apply**.

You have completed configuring the GGSN service.

## Configuring an Authentication Profile

An authentication profile defines the authentication policy when the controller is used as a RADIUS proxy service for WLAN. RADIUS protocol is used for interfacing between Access Points (AP) and the controller as well as between the controller and a third party AAA (Authentication, Authorization and Accounting) server. The controller acts as RADIUS proxy for authentication and authorization and as a RADIUS client for accounting.

Follow these steps to create an authentication profile.

1. Go to **Configuration > Services & Profiles**.
2. On the sidebar under **Profiles**, click **Authentication**.

The **Authentication Profiles** page appears.

3. Click **Create New**.

The **Create New Authentication Profile** form appears.

4. In **Name**, type a name for the authentication profile that you are adding.
5. In **Friendly Name**, type a name that will be displayed as the authentication profile that you are adding.
6. In **Description**, type a brief description of the profile.

This is an optional field.

7. In **Service Protocol**, choose **RADIUS** setting.

This is the default setting.

8. **RFC 5580 Out of Band Local Delivery:** Select the **Enable for Ruckus APs Only** check box if you want AP location information for Ruckus Wireless APs to be included in RADIUS accounting messages.

AP location information can be retrieved from the APs if their location information was entered statically (for APs without GPS) or automatically acquired (for APs with GPS).

9. In the **Primary Server** section, configure the settings of the primary RADIUS server.

- **IP Address:** Type the IP address of the AAA server.
- **Port:** Type the port number of the AAA server. The default RADIUS server port number is 1812 and the default RADIUS Accounting server port number is 1813.
- **Shared Secret:** Type the AAA shared secret.
- **Confirm Secret:** Retype the shared secret to confirm.

10. In the **Secondary Server** section, configure the settings of the secondary RADIUS server.

**NOTE:** The **Secondary Server** section is only visible if you selected the **Enable backup RADIUS server** check box earlier.

- **IP Address:** Type the IP address of the secondary AAA server.
- **Port:** Type the port number of the secondary AAA server port number. The default RADIUS server port number is 1812 and the default RADIUS Accounting server port number is 1813.
- **Shared Secret:** Type the AAA shared secret.
- **Confirm Secret:** Retype the shared secret to confirm.

#### 11. Configure the **Health Check Policy** options.

These options define the health monitoring settings of the primary and secondary RADIUS servers, when the controller is configured as RADIUS proxy for RADIUS Authentication and Accounting messages.

Option	Description
<b>Response Window</b>	Set the time (in seconds) after which, if the AAA server does not respond to a request, the controller will initiate the "zombie period" (see below). If the primary AAA server does not respond to RADIUS messages sent after Response Window expires, the controller will forward the retransmitted RADIUS messages to the secondary AAA server. Note that the zombie period is not started immediately after the Response Window expires, but after the configured <b>Response Window</b> plus $\frac{1}{4}$ of the configured <b>Zombie Period</b> . The default <b>Response Window</b> is 20 seconds.
<b>Zombie Period</b>	Set the time (in seconds) after which, if the AAA server does not respond to ANY packets during the zombie period, it will be considered to inactive or unreachable. An AAA server that is marked "zombie" (inactive or unreachable) will be used for proxying with a low priority. If there are other live AAA servers, the controller will attempt to use these servers first instead of the zombie AAA server. The controller will only proxy requests to a zombie server only when there are no other live servers. Any request that is proxied to an AAA server will continue to be sent to that AAA server until the home server is marked inactive or unreachable. At that point, the request will fail over to another server, if a live AAA server is available. The default <b>Zombie Period</b> is 40 seconds.
<b>Revive Interval</b>	Set the time (in seconds) after which, if no RADIUS messages are proxied to the AAA server after it has been marked as inactive or unreachable, the controller will mark the AAA server as active again (and assume that it has become reachable again). The default Revive Interval is 120 seconds.
<b>No Response Fail</b>	Click <b>Yes</b> to respond with a reject message to the NAS if no response is received from the RADIUS server. Click <b>No</b> to skip sending a response.
	<b>CAUTION:</b> To ensure that the RADIUS failover mechanism functions correctly, either accept the default values for the <b>Response Window</b> , <b>Zombie Period</b> , and <b>Revive Interval</b> , or make sure that the value for <b>Response Window</b> is always higher than the value for RADIUS NAS request timeout multiplied by the value for RADIUS NAS max number of retries. For information on configuring

**Option**      **Description**

the RADIUS NAS request timeout and max number of retries, see *Administrator Guide*. For 3rd party APs, you must ensure that the configured **Response Window** on the controller is higher than the RADIUS NAS request timeout multiplied by the RADIUS value. The maximum number of retries is configured at 3rd party controller/ AP.

**12** Configure the **Rate Limiting** options.

- **Maximum Outstanding Requests (MOR):** Set the maximum outstanding requests per server. Type 0 to disable it, or set a value between 10 and 4096. When the MOR value is reached, RADIUS messages are dropped and a corresponding event is triggered.
- **Threshold (% of MOR):** Set a percentage value of the MOR at which (when reached) the controller will generate an event. For example, if the MOR is set to 1000 and the threshold is set to 50%, the controller will generate an event when the number of outstanding requests reaches 500.
- **Sanity Timer:** Set a timer (in seconds) that the controller will use to assert event 1301. When the load condition drops below the configured **Threshold** value (above), the controller will wait for the sanity timer to elapse before asserting event 1301.

**13 Group Traffic Profile Mapping:** Fill in this field only if you are creating a user role based on Group attributes extracted from an Active Directory or LDAP server

Enter the **User Group** name here. Active Directory/LDAP users with the same group attributes are automatically mapped to this user role.

**14** Click **OK** at the bottom of the form.

You have completed adding an authentication profile.

**Hosted AAA Server RADIUS Settings**

Interim Accounting Interval (secs): \* 0

Session Timeout (secs): \* 0

Session Idle Timeout (secs): \* 120

**PLMN ID Settings**

Mobile Country Code: \* [ ]

Mobile Network Code: \* [ ]

Realm	Protocol	Auth Service	Auth Method	Dynamic VLAN ID
No Match	NA	NA-Request Rejected	Non-3GPP Call Flow	
Unspecified	NA	NA-Request Rejected	Non-3GPP Call Flow	

Note: If device onboarding was done with credential type 'remote', then map your 'realm' value to its respective authentication service PLUS define 'Unspecified' realm & map it to corresponding authentication service to properly handle legacy (non-Hotspot 2.0) devices.

**Figure 248: The Authentication Profile form**

## Configuring an Accounting Profile

An accounting profile defines the accounting policy when the controller is used as a RADIUS proxy for WLAN services.

Follow these steps to create an accounting profile.

1. Go to **Configuration > Services & Profiles**.
2. On the sidebar under **Profiles**, click **Accounting**.

The **Accounting Profiles** page appears.

3. Click **Create New**.

The **Create New Accounting Profile** form appears.

4. In **Name**, type a name for the authentication profile that you are adding.
5. In **Description**, type a brief description of the profile.

This is an optional field.

6. In **Service Protocol**, choose **RADIUS** setting.

This is the default setting.

7. In the **Primary Server** section, configure the settings of the primary RADIUS server.

- **IP Address:** Type the IP address of the AAA server.
- **Port:** Type the port number of the AAA server. The default RADIUS server port number is 1812 and the default RADIUS Accounting server port number is 1813.
- **Shared Secret:** Type the AAA shared secret.
- **Confirm Secret:** Retype the shared secret to confirm.

8. In the **Secondary Server** section, configure the settings of the secondary RADIUS server.

**NOTE:** The **Secondary Server** section is only visible if you selected the **Enable backup RADIUS server** check box earlier.

- **IP Address:** Type the IP address of the secondary AAA server.
- **Port:** Type the port number of the secondary AAA server port number. The default RADIUS server port number is 1812 and the default RADIUS Accounting server port number is 1813.
- **Shared Secret:** Type the AAA shared secret.
- **Confirm Secret:** Retype the shared secret to confirm.

9. Configure the **Health Check Policy** options.

These options define the health monitoring settings of the primary and secondary RADIUS servers, when the controller is configured as RADIUS proxy for RADIUS Authentication and Accounting messages.

Option	Description
<b>Response Window</b>	Set the time (in seconds) after which, if the AAA server does not respond to a request, the controller will initiate the "zombie period" (see below). If the



Option	Description
	primary AAA server does not respond to RADIUS messages sent after Response Window expires, the controller will forward the retransmitted RADIUS messages to the secondary AAA server. Note that the zombie period is not started immediately after the <b>Response Window</b> expires, but after the configured <b>Response Window</b> plus $\frac{1}{4}$ of the configured <b>Zombie Period</b> . The default <b>Response Window</b> is 20 seconds.
<b>Zombie Period</b>	Set the time (in seconds) after which, if the AAA server does not respond to ANY packets during the zombie period, it will be considered to inactive or unreachable. An AAA server that is marked "zombie" (inactive or unreachable) will be used for proxying with a low priority. If there are other live AAA servers, the controller will attempt to use these servers first instead of the zombie AAA server. The controller will only proxy requests to a zombie server only when there are no other live servers. Any request that is proxied to an AAA server will continue to be sent to that AAA server until the home server is marked inactive or unreachable. At that point, the request will fail over to another server, if a live AAA server is available. The default <b>Zombie Period</b> is 40 seconds.
<b>Revive Interval</b>	Set the time (in seconds) after which, if no RADIUS messages are proxied to the AAA server after it has been marked as inactive or unreachable, the controller will mark the AAA server as active again (and assume that it has become reachable again). The default <b>Revive Interval</b> is 120 seconds.
<b>No Response Fail</b>	Click <b>Yes</b> to respond with a reject message to the NAS if no response is received from the RADIUS server. Click <b>No</b> to skip sending a response.  <b>CAUTION:</b> To ensure that the RADIUS failover mechanism functions correctly, either accept the default values for the <b>Response Window</b> , <b>Zombie Period</b> , and <b>Revive Interval</b> , or make sure that the value for <b>Response Window</b> is always higher than the value for <b>RADIUS NAS request timeout</b> multiplied by the value for <b>RADIUS NAS max number of retries</b> . For information on configuring the <b>RADIUS NAS request timeout</b> and <b>max number of retries</b> , see Administrator Guide. For 3rd party APs, you must ensure that the configured <b>Response Window</b> on the controller is higher than the <b>RADIUS NAS request timeout</b> multiplied by the RADIUS value. The maximum number of retries is configured at 3rd party controller/ AP.

## 10. Configure the **Rate Limiting** options.

- **Maximum Outstanding Requests (MOR):** Set the maximum outstanding requests per server. Type 0 to disable it, or set a value between 10 and 4096. When the **MOR** value is reached, RADIUS messages are dropped and a corresponding event is triggered.
- **Threshold (% of MOR):** Set a percentage value of the **MOR** at which (when reached) the controller will generate an event. For example, if the **MOR** is set to 1000 and the threshold is set to 50%, the controller will generate an event when the number of outstanding requests reaches 500.

- **Sanity Timer:** Set a timer (in seconds) that the controller will use to assert event 1301. When the load condition drops below the configured **Threshold** value (above), the controller will wait for the sanity timer to elapse before asserting event 1301.

11. Click **OK** at the bottom of the form.

You have completed adding an accounting profile.

**Create New Accounting Profile**

Name: \*

Description:

Accounting Service Per Realm

Realm \*  Accounting Service \*

Realm	Accounting Service
No Match	NA-Disabled
Unspecified	NA-Disabled

Note: A realm to service mapping define the accounting service for each of the realm specified in this table. When the accounting service for a particular realm is 'NA', then accounting is disabled.

Figure 249: Accounting Profile form

## Configuring TTG+PDG Forwarding Profiles

A TTG+PDG forwarding profile defines the gateway and tunnel configurations for core network GTP tunnels and LBO configurations.

Follow these steps to add a TTG+PDG profile.

1. On the **TTG+PDG Forwarding Profiles** page, click **Create New**.

The **Create New TTG+PDG Forwarding Profile** form appears.

2. In **Name**, type a name for the TTG+PDG Profile that you are adding.

3. In **Description**, give a brief description of the profile created.

This is an optional field.

4. In **Common Settings**, configure the following:

- **APN Format to GSN:** Select either **DNS** or **String** from the drop-down list.
- **APN-OI for DNS Resolution:** Specify if the APN-OI is required.
- **# of Accounting Retry:** Specify the interval (in minutes) at which the controller will recheck the primary TTG+PDG RADIUS profile, if it is available. The default interval is 5 minutes.
- **Accounting Retry Timeout (secs):** Type the timeout period (in seconds) after which an expected response message is considered to have failed.
- **PDG UE Session Idle Timeout (secs):** Type the timeout period (in seconds) after which an expected response message is considered to have failed.

5. In **DHCP Relay**, configure the following options to enable the DHCP relay agent in the controller:

Option	Description
<b>Enable DHCP Relay</b>	Select this check box to enable the DHCP relay agent in the controller.
<b>DHCP Server 1</b>	Type the IPv4 address of the DHCP server that will allocate IP addresses to DHCP clients.
<b>DHCP Server 2</b>	If a secondary DHCP server exists on the network, type the IPv4 address of the secondary server.
<b>DHCP Option 82</b>	Select this check box If you want the DHCP relay agent (in this case, the controller) to insert specific identification information into requests that are forwarded to the DHCP server. If you enabled <b>DHCP Option 82</b> , you can configure the following Option 82 sub options by selecting the corresponding check boxes: <ul style="list-style-type: none"><li>• <b>Subopt-1 with format:</b> You can customize sub option 1 (Circuit ID) to send only the AP's MAC address in hexadecimal format or the MAC address and ESSID. The default format is:<ul style="list-style-type: none"><li>• IFName:VLAN-ID:ESSID:AP-Model:AP-Name:AP-MAC</li></ul></li><li>• <b>Subopt 2 with format:</b> You can customize sub option 2 (Remote ID), which sends the client's MAC address by default, to send the AP's MAC address, or the client MAC plus ESSID or AP MAC plus ESSID.</li><li>• <b>Subopt-150 with VLAN ID:</b> This sub option encapsulates the VLAN ID.</li><li>• <b>Subopt-151 with format:</b> This sub option can encapsulate either the ESSID or a configurable <b>Area Name</b>.</li></ul>

6. In **Forwarding Policy Per Realm**, specify the forwarding policy for each realm in the table. Configure the following:

- **APN**
- **APN Type**
- **Route Type**
- **Profile Name**

7. In **Default APN Settings**, configure the following:

- **No Matching Realm Found**
- **No Realm Specified**

8. Click **Create New**.

You have completed adding a TTG+PDG profile.

Figure 250: The Create New TTG+PDG Forwarding Profile form

## Configuring the WISPr (Hotspot) Services of an AP Zone

Configuring WISPr (Hotspot) services of the AP Zone is a procedural step required to set up the captive portal.

Follow these steps to configure the hotspot service of the zone template.

1. Click **Configuration > AP Zones**.
2. On the **AP Zone List** page, click the AP zone for which you want to create a hotspot service.
3. On the sidebar, click **WISPr (Hotspot)**.

The **WISPr (Hotspot) Services** page appears.

4. Click **Create New**.

The form for creating a new hotspot service appears.

5. In the **General Options** section, configure the following options:

- **Name:** Type a name for the hotspot service.
- **Description:** Type a description for the hotspot service.
- **Type:** Click **Registered Users** if you want only users with existing profiles on the controller to be able to connect to this hotspot. Click **Guest-Access** if you want guest users to be able to connect to this hotspot.

6. In the **Redirection** section, configure the following options:

Option	Description
<b>Smart Client Support</b>	Select one of the following options: <ul style="list-style-type: none"> <li>• <b>None:</b> Select this option to disable Smart Client support on the hotspot service.</li> </ul>

Option	Description
	<ul style="list-style-type: none"><li>• <b>Enable:</b> Selection this option to enable Smart Client support.</li><li>• <b>Only Smart Client Allowed:</b> Select this option to allow only Smart Clients to connect to the hotspot service.</li></ul> <p>For more information, see <a href="#">Configuring Smart Client Support</a> on page 279.</p>
<b>Logon URL</b>	Type the URL of the subscriber portal (the page where hotspot users can log in to access the service). For more information, see <a href="#">Configuring the Hotspot Logon URL</a> on page 279.
<b>Start Page</b>	Set where users will be redirected after they log in successfully: <ul style="list-style-type: none"><li>• <b>Redirect to the URL that user intends to visit:</b> You could redirect users to the page that they want to visit.</li><li>• <b>Redirect to the following URL:</b> You could set a different page where users will be redirected (for example, your company website).</li><li>•</li></ul>

7. In the **User Session** section, configure the following options:

- **Session Timeout:** Set a time limit (in minutes) after which users will be disconnected from the hotspot service and will be required to log on again.
- **Grace Period:** Set the time period (in minutes) during which disconnected users are allowed access to the hotspot service without having to log on again.

8. In the **Location Information** section, configure the following options:

Option	Description
<b>Location ID</b>	Type the ISO and ITU country and area code that the AP includes in accounting and authentication requests. The required code includes: <ul style="list-style-type: none"><li>• <b>isocc (ISO-country-code):</b> The ISO country code that the AP includes in RADIUS authentication and accounting requests.</li><li>• <b>cc (country-code):</b> The ITU country code that the AP includes in RADIUS authentication and accounting requests.</li><li>• <b>ac (area-code):</b> The ITU area code that the AP includes in RADIUS authentication and accounting requests.</li><li>• <b>network</b></li></ul> <p>The following is an example of what the Location ID entry should look like: <code>isocc=us,cc=1,ac=408,network=RuckusWireless</code></p>

**Location Name** Type the name of the location of the hotspot service.

9. In **Walled Garden**, click **Create New** to add a walled garden.

A walled garden is a limited environment to which an unauthenticated user is given access for the purpose of setting up an account.

10. In the box provided, type a URL or IP address to which you want to grant unauthenticated users access.

You can add up to 128 network destinations to the walled garden. Network destinations can be any of the following:

- A single IP address (for example, 10.11.12.13)
- A Classless Inter-Domain Routing (CIDR) notation (for example, 10.11.12.100/28)
- An IP address and subnet mask (for example, 10.11.12.13 255.255.255.0)
- An exact website address (for example, www.ruckuswireless.com)
- Website address with regular expression (for example, \*.ruckuswireless.com, \*.com, \*)

After the account is established, the user is allowed out of the walled garden. URLs will be resolved to IP addresses. Users will not be able to click through to other URLs that may be presented on a page if that page is hosted on a server with a different IP address. Avoid using common URLs that are translated into many IP addresses (such as www.yahoo.com), as users may be redirected to re-authenticate when they navigate through the page.

11. Click **Create New**.

You have completed configuring a hotspot service of the AP zone.

The screenshot shows a web form titled "Create New Hotspot Portal". The form is organized into several sections, each with a header and a plus icon to expand it. The sections are: "General Options" containing "Portal Name" (with an asterisk indicating it is required) and "Portal Description"; "Redirection"; "User Session"; "Location Information" containing "Location ID" and "Location Name" (with example text provided for each); and "Walled Garden". At the bottom of the form are "OK" and "Cancel" buttons.

Figure 251: The Create New Hotspot Profile form

## AP Zone WLAN Services & Group

Follow these steps to configure tunneling combination for Captive Portal.

**NOTE:** There is only 1 configuration combination allowed for usage of this feature.

1. Click **Configuration > AP Zones > WLAN**.
2. On the **AP Zone List** page, select the AP zone in the **WLAN Services & Group** page.
3. In **WLAN Usage** options:
  - **Access Network** - Enable **Tunnel WLAN traffic through Ruckus GRE**.
  - **Core Network** - Enable **Bridge** option
  - **Authentication Type** - Enable **Hotspot (WISPr)**
4. In **Authentication options**:

- **Method**- Enable **MAC Address**)

5. In **Hotspot Portal** options:

- **Hotspot (WISPr) Portal** - Choose the portal as hotspot
- **Authentication Service** - Enable **using RADIUS authentication as the controller proxy**
- **Accounting Service** - Enable **using RADIUS authentication as the controller proxy**

6. In **Forwarding Profile** options:

- **Forwarding Policy** - Choose the forwarding policy as **TTG**.
- Enable **WISPr TTG support**

7. In **Advanced** options:

- **User Traffic Profile** - Choose the forwarding policy as **Bridge**.
- Enable **WISPr TTG support**

8. Click **Apply**.

You have completed configuring **WLAN for Captive Portal**. With this you have completed configuration for Captive Portal.

**Edit WLAN Config: [INDUS4-PDG] of zone [INDUS\_4SETUP]**

**General Options**

**WLAN Usage**

Access Network:  Tunnel WLAN traffic through Ruckus GRE

Core Network: \*  Bridge  L3oGRE  L2oGRE  TTG-PDG  PMPv6  Mixed Tunnel Mode

Authentication Type: \*  Standard usage (For most regular wireless networks)  
 Hotspot (WISPr)  
 Guest Access + Hotspot 2.0 Online Signup  
 Web Authentication  
 Hotspot 2.0  
 Hotspot 2.0 Secure Online Signup (OSDH)

**Authentication Options**

Method: \*  Open  802.1x EAP  MAC Address

**Encryption Options**

Method: \*  WPA2  WPA-Mixed  WEP-64 (40 bits)  WEP-128 (104 bits)  None

Algorithm: \*  AES  AUTO (TKIP+AES)

Passphrase: \*

802.11w MFP: \*  Disabled  Capable  Required

**Hotspot Portal**

Hotspot (WISPr) Portal: \* wispr

Authentication Service:  Use SCG as Proxy RAD\_AUTH

Accounting Service:  Use SCG as Proxy RAD\_ACCT Send interim update every 10 Minutes (0-1440)

**Forwarding Profile**

Forwarding Policy: \* Bridge

Enable WISPr-TTG Support:  Enable WISPr-TTG Support

**Options**

**RADIUS Options**

**Advanced Options**

User Traffic Profile: System Default

L2 Access Control: Disable

Device Policy: Disable

Access VLAN:  Enable VLAN Pooling  
VLAN ID 904

Figure 252: Configuring WLAN

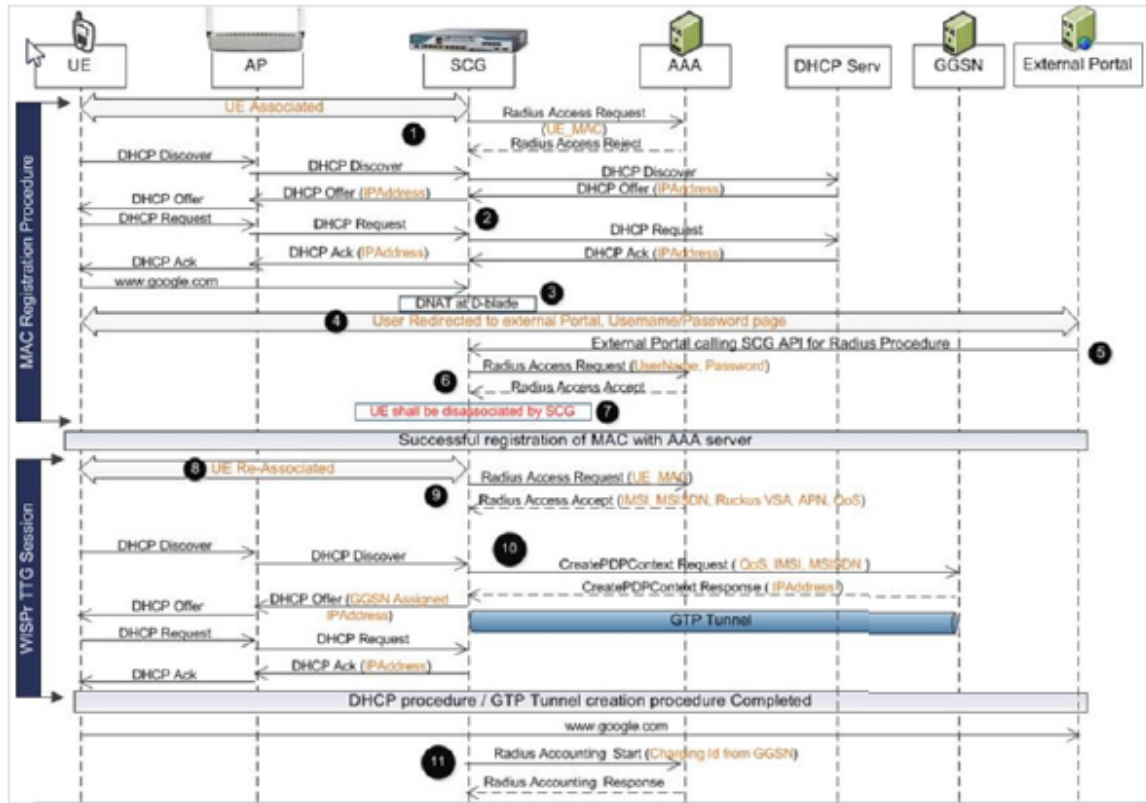


## Captive Portal Workflows and VSA

This section describes the workflow of the captive portal and VSA.

### Successful Captive Portal Authentication

Captive portal authentication workflow describes the workflow where the external portal sends a message to the controller to initiate RADIUS authentication to complete the portal authentication procedure.



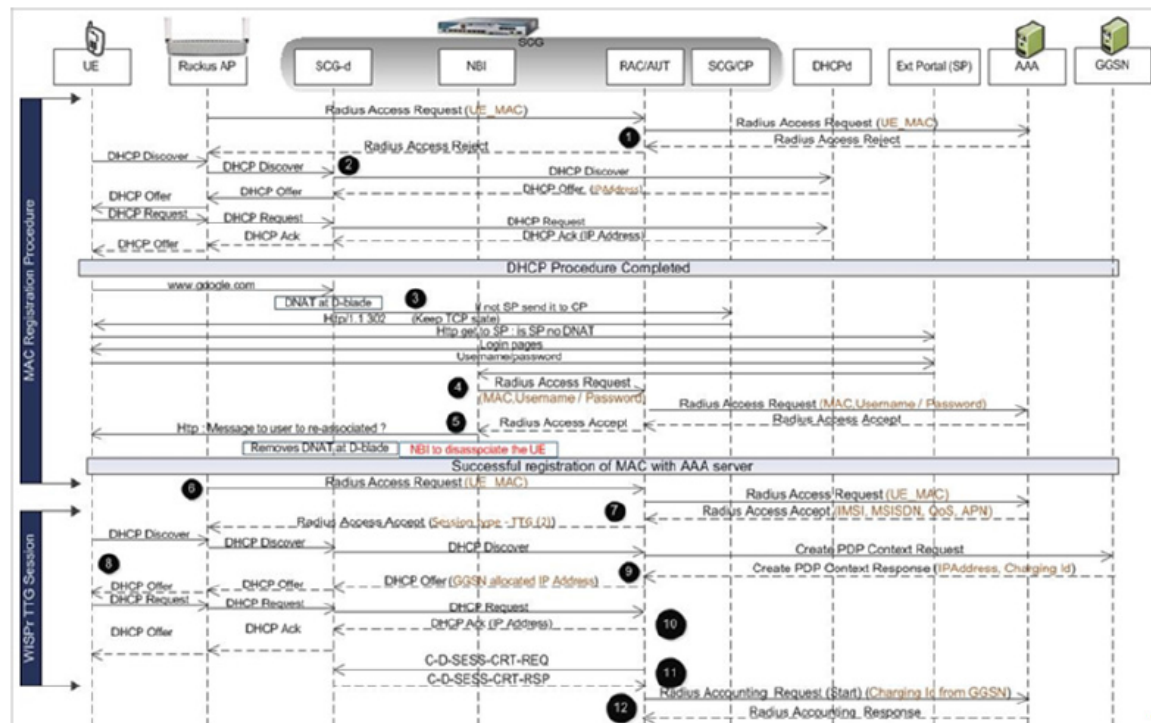
1. The UE associated controller triggers MAC based authentication, which is rejected by the AAA server since the UE MAC is not registered.
2. A DHCP procedure is triggered and the IP address is allocated from the DHCP server.
3. When the UE tries to browse a DNAT procedure is performed at the data plane since the user is not yet authenticated.
4. The user is redirected to login page of the external portal.
5. On user entering his login credentials the external portal calls the controller's API (NBI API) to complete the authentication procedure
6. The controller triggers the RADIUS CHAP authentication towards the AAA server.
7. On successful authentication the user is disassociated. This complete the UE registration procedure with external AAA server.
8. The UE re-associates to the AP.
9. MAC authentication is triggered by the controller. The AAA server responds with access accept with IMSI, MSISDN, QoS (optional) and APN (optional).

10. DHCP procedure is initiated by UE. During this procedure the controller establishes GTP tunnel and DHCP offer is sent with GGSN to the assigned IP address.
11. On completion of the DHCP procedure the user continues with the data session. The controller also triggers the accounting message towards the AAA accounting server.

Figure 253: Captive portal authentication workflow

## Successful GTP Tunnel Establishment

Figure 254: Successful GTP tunnel establishment on page 402 shows the workflow of successful GTP tunnel establishment for WISPr authentication and RADIUS CHAP from the controller.



1. The UE associated controller triggers MAC based authentication, which is rejected by the AAA server since the UE MAC is not registered.
2. A DHCP procedure is triggered and the IP address is allocated from the DHCP server.
3. When the UE tries to browse a DNAT procedure is performed at the data plane since the user is not yet authenticated.
4. The user is redirected to login page of the external portal.
5. On user entering his login credentials the external portal calls the controller's API (NBI API) to complete the authentication procedure
6. The controller triggers the RADIUS CHAP authentication towards the AAA server.
7. On successful authentication the user is disassociated. This complete the UE registration procedure with external AAA server.
8. The UE re-associates to the AP.
9. MAC authentication is triggered by the controller. The AAA server responds with access accept with IMSI, MSISDN, QoS (optional) and APN (optional).

- 10 DHCP procedure is initiated by UE. During this procedure, the controller establishes a GTP tunnel and a DHCP offer is sent with GGSN to the assigned IP address.
11. Upon completion of the DHCP procedure, the user continues with the data session.
- 12 The controller also triggers the accounting message towards the AAA accounting server.

**Figure 254: Successful GTP tunnel establishment**

### Ruckus Wireless VSAs for the Captive Portal

Ruckus Wireless vendor-specific attributes (VSAs) are values included in Radius access accept messages by the AAA server.

The following table lists the Ruckus Wireless VSAs.

**Table 26: Ruckus Wireless VSAs**

Ruckus VSA	APN Resolution	Controller Behavior/Action
REDIRECT-AFTER-GTP	GTPv1	- GTP tunnel with GGSN - Ruckus VSA Ruckus-Session-Type = TTG in Access Accept to AP
REDIRECT-AFTER-GTP	GTPv2	- GTP tunnel with PGW - Ruckus VSA Ruckus-Session-Type = TTG in Access Accept to AP
REDIRECT-AFTER-GTP	PDG	- Non-TTG session or VANILLA-REDIRECT - No Ruckus VSA Ruckus-Session-Type (125) in Access Accept
NULL (No VSA received from AAA)	GTPv1	- GTP tunnel with GGSN - Ruckus VSA Ruckus-Session-Type = TTG in Access Accept to AP
NULL (No VSA received from AAA)	GTPv2	- GTP tunnel with PGW - Ruckus VSA Ruckus-Session-Type = TTG in Access Accept to AP
NULL (No VSA received from AAA)	PDG	- Non-TTG session or VANILLA-REDIRECT - No Ruckus VSA Ruckus-Session-Type (125) in Access Accept
VANILLA-REDIRECT	GTPv1	- Non-TTG session or VANILLA-REDIRECT - No Ruckus VSA Ruckus-Session-Type (125) in Access Accept

Ruckus VSA	APN Resolution	Controller Behavior/Action
VANILLA-REDIRECT	GTPv2	- Non-TTG session or VANILLA-REDIRECT - No Ruckus VSA Ruckus-Session-Type (125) in Access Accept
VANILLA-REDIRECT	PDG	- Non-TTG session or VANILLA-REDIRECT - No Ruckus VSA Ruckus-Session-Type (125) in Access Accept

## Statistics Files the Controller Exports to an FTP Server

In this chapter:

- [AP Inventory](#)

If you added an FTP server to the controller, the controller will export statistics files to that FTP server, either on demand or based on a schedule.

**NOTE:** The controller statistics files use Unix timestamps in milliseconds (for example, “1.40729E+12” is Unix timestamp for “8/6/2014 2:30:00 AM”). You can use an online timestamp conversion tool to convert Unix timestamps to human-readable timestamps.

**NOTE:** The file name format of the Statistics file is as follows:

<report title>-YYYY-MM-DD\_HH-MM-SS-MS\_ZZ

where

MS stands for three-digit milliseconds.

ZZ is a random number to avoid the file name conflict when a user subscribes to several reports but based on the same filter. ZZ ranges between 00-99.

For example: New\_Client-2015-11-17\_08-00-16-031\_59.csv

### AP Inventory

The AP inventory file contains detailed information about each AP that the controller was managing at the time the file was uploaded to the FTP.

The default AP inventory file name format is:

ap\_YYYY\_MM\_DD\_hh\_mm\_ss\_ms.csv

where ms stands for three-digit milliseconds.

The following table lists the attributes in the AP inventory file.

**Table 27: Attributes in the AP inventory file**

Column Name	Description
key	MAC address of the AP
zoneUUID	ID of the zone to which the AP belongs
gpsSource	GPS coordinates (for example, 47.633625,-122.186446)
lastSeen	Unix timestamp of AP's latest connection
fwVersion	Current AP firmware version
meshRole	Mesh role assigned to the AP. Possible values include: <ul style="list-style-type: none"> <li>• 0: Disabled</li> <li>• 1: RAP</li> <li>• 2: MAP</li> <li>• 3: EMAP</li> <li>• 4: Mesh is down</li> <li>• 5: Mesh role is undefined</li> </ul>
location	AP location info
rebootStartTime	Time when AP reboot was started
type	The type of JSON string
deviceName	Device name assigned to the AP
description	Description of the AP
extIp	External IP address assigned to the AP
registrationState	Registration state of the AP. Possible values include: <ul style="list-style-type: none"> <li>• 0: Pending</li> <li>• 1: Approved</li> <li>• 2: Rejected</li> </ul>
gpsInfo	GPS coordinates of the AP's location (if configured)
countryCode	Country code assigned to the AP
cableModemInfo	Cable modem info (if the AP has a cable modem component)
enableWlanservice24	Enable 2.4GHz radio
connectionStatus	Current connection status of the AP
heartbeatLost	Time AP heartbeat was lost (if any). If heartbeat has not been lost, the value is "FALSE."
meshSSID	Mesh SSID used by the AP to form the mesh
extPort	External port

Column Name	Description
apGroupUUID	Table key assigned to the AP group to which the AP belongs
model	Model of the AP
timeStamp	Timestamp of the record (in Unix timestamp)
wsgWlanIDAndClientCount	Client count of each WLAN
clientCount	Current client count on the AP
hops	Number of devices between this mesh AP and the root AP
bladeld	ID of the control blade
enableWlanservice50	Enable 5GHz radio
approvedTime	Unix timestamp when the AP registration was approved
registrationTime	Unix timestamp when the AP registered with the controller
uptime	Number of minutes elapsed since AP was last rebooted
lastRegistrationInfo	AP registration info
ip	IP address assigned to the AP
dpMac	Data plane MAC address
ap	MAC address of the AP
provisionTag	Tag used to preprovision the AP to its current zone
tagged	Tagged AP is the AP with daily traffic exceed the customized threshold value
channel	Radio channel that the AP is using
serial	Serial number of the AP
apMac	MAC address of the AP
provisionStage	Current provision status of the AP
provisionMethod	AP join method (Discovered/Preprovision/Swap)
registrationState	Registration state of the AP. Possible values include: <ul style="list-style-type: none"> <li>• 0: Pending</li> <li>• 1: Approved</li> <li>• 2: Rejected</li> </ul>
administrativeState	AP WLAN state. Possible values include 0 (unlocked) and 1 (locked).

## Control Plane Statistics

The control plane statistics file contains detailed general information about the control plane.

Its default file name format is: `controlBlade__YYYY_MM_DD_hh_mm_ss_ms.csv`

where `ms` stands for three-digit milliseconds.

The following table lists the control plane statistical attributes.

**Table 28: Attributes in the control plane statistics file**

Column Name	Description
key	Control plane ID
hostName	Name of the control plane
model	Model of the control plane
serialNumber	Serial number of the control plane
mac	Serial number of the control plane
startTime	Timestamp when the control plane was set up
description	Description of the control plane

## Mobility Zone Inventory

The mobility zone inventory file contains detailed information about every zone that existed on the controller at the time the file was uploaded to the FTP server.

The default zone inventory statistics file name format is:

`mobilityZone_YYYY_MM_DD_hh_mm_ss_ms.csv`

where `ms` stands for three-digit milliseconds.

The following table lists the mobility zone inventory attributes.

**Table 29: Attributes in the mobility zone inventory file**

Column Name	Description
key	ID assigned to the zone
mobilityZoneName	Name assigned to the zone
description	Description of the zone
createdDatetime	Date and time (in Unix timestamp) when the zone was created



## Zone Statistics

The zone statistics file contains detailed information on traffic, client associations, and AP uptime at the zone level during the configured period of time. The default file name format depends on the time period specified for uploading the statistics file:

- If the zone statistics file is exported daily: `statsZoneDay_YYYY_MM_DD_hh_mm_ss_ms.csv`
- If the zone statistics file is exported hourly:  
`statsZoneHour_YYYY_MM_DD_hh_mm_ss_ms.csv`

where `ms` stands for three-digit milliseconds.

**NOTE:** The term "period" in the following table refers to the time interval (hourly or daily) selected in **Statistics Date Interval** on the web interface.

The following table lists the attributes in the zone statistics file

**Table 30: Attributes in the zone statistics file**

Column Name	Description
key	ID of the zone
airtime	Total airtime of channel utilization during the period
minNumClients	Minimum number of concurrently connected clients during the period
rxFrames_r	Total number of frames received during the period
txRateKbps	Transmit data rate in kilobits per second for the period
rxRateKbps	Receive data rate in kilobits per second for the period
newAssoc	Number of newly associated clients during the period
txBytes_r	Total number of bytes transmitted during the period
rxBytes_r	Total number of bytes received during the period
timeStamp	Data aggregation time (in Unix timestamp)
txFrames_r	Total number of frames transmitted during the period
uptime_r	Percentage of time during which the AP was up during the period. Uptime is computed based on the up and down events that occurred.
avgNumClients	Average number of concurrently connected clients during the period
failedAssoc	Number of failed associated clients during the period
maxNumClients	Maximum number of concurrently connected clients during the period

## AP Statistics

The AP statistics file contains detailed information on traffic, client associations, and AP uptime at the AP level during the configured period of time.

The default AP statistics file name format depends on the time period specified for uploading the file:

- If the AP statistics file is exported daily: `statsAPDay_YYYY_MM_DD_hh_mm_ss_ms.csv`
  - If the AP statistics file is exported hourly: `statsAPHour_YYYY_MM_DD_hh_mm_ss_ms.csv`
- where `ms` stands for three-digit milliseconds.

**NOTE:** The term "period" in the following table refers to the time interval (hourly or daily) selected in **Statistics Date Interval** on the web interface.

The following table lists the attributes in the AP statistics file.

**Table 31: Attributes in the AP statistics file**

Column Name	Description
key	MAC address of the AP
airtime	Total airtime of channel utilization during the period
minNumClients	Minimum number of concurrently connected clients during the period
txRateKbps	Transmit data rate in kilobits per second for the period
newAssoc	Number of newly associated clients during the period
txBytes_r	Total number of bytes transmitted during the period
rxRateKbps	Received data rate in kilobits per second for the period
rxBytes_r	Total number of bytes received during the period
rxFrames_r	Total number of frames received during the period
uptime_r	Percentage of time during which the AP was up during the period. Uptime is computed based on the up and down events that occurred.
avgNumClients	Average number of concurrently connected clients during the period
txFrames_r	Total number of frames transmitted during the period
failedAssoc	Number of clients that failed to associate with the AP during the period
maxNumClients	Maximum number of concurrently connected clients during the period
timestamp	Data aggregation time (in Unix timestamp)

## Zone Time Radio Statistics

The default file name format depends on the time period specified for uploading the statistics file.

- If the statistics file is exported daily:  
`statsZoneTimeRadioDay_YYYY_MM_DD_hh_mm_ss_ms.csv`
- If the statistics file is exported hourly:  
`statsZoneTimeRadioHour_YYYY_MM_DD_hh_mm_ss_ms.csv`

where `ms` stands for three-digit milliseconds.

The following table lists the attributes in the zone time radio statistics file

**Table 32: Attributes in the zone time radio statistics file**

Column Name	Description
key	ID of the zone
airtime	Total airtime of channel utilization during the period
minNumClients	Minimum number of concurrently connected clients during the period
airtimeB	Busy airtime (channel) utilization during the period
txBytes_r	Total number of bytes transmitted during the period
rxFrames_r	Total number of data frames received during the period
newAssoc	Number of newly associated clients during the period
timestamp	Data aggregation time
txFrames_r	Total number of frames transmitted during the period
rxBytes_r	Total number of bytes received during the period
airtimeRx	Total receiving airtime (channel) utilization during the period
avgNumClients	Average number of concurrently connected clients during the period
airtimeTx	Total transmitting airtime (channel) utilization during the period
radiold	Identifies the specific radio used by the AP
failedAssoc	Number of clients that failed to associate with the AP during the period
maxNumClients	Maximum number of concurrently connected clients during the period
phyError	Number of PHY errors during the period

## Zone Time WLAN Statistics

The default file name format depends on the time period specified for uploading the statistics file.

- If the statistics file is exported daily:  
`statsZoneTimeWlanDay_YYYY_MM_DD_hh_mm_ss_ms.csv`
- If the statistics file is exported hourly:  
`statsZoneTimeWlanHour_YYYY_MM_DD_hh_mm_ss_ms.csv` where `ms` stands for three-digit milliseconds.

The following table lists the attributes in the zone time WLAN statistics file.

**Table 33: Attributes in the zone time WLAN statistics file**

Column Name	Description
key	ID assigned to the zone
tenantId	ID of the MVNO account
minNumClients	Minimum number of concurrently connected clients during the period
txDataFrames_r	Total number of data frames transmitted during the period
txBytes_r	Total number of bytes transmitted during the period
txRateKbps	Transmit data rate in kilobits per second during the period
rxMgmtFrames_r	Total number of management frames received during the period
timestamp	Data aggregation time
txFrames_r	Total number of frames transmitted during the period
wsgWlanId	WLAN ID of the controller
rxBytes_r	Total number of bytes received during the period
avgNumClients	Average number of concurrently connected clients during the period
txDataBytes_r	Total number of data bytes transmitted during the period
radioid	Identifies the specific radio used by the AP
ssid	SSID of the WLAN
maxNumClients	Maximum number of concurrently connected clients during the period
rxMgmtBytes_r	Total number of management bytes received during the period
rxDataBytes_r	Total number of data bytes received during the period
wlanId	Identifies the specific WLAN ID on the AP

Column Name	Description
rxFrames_r	Total number of frames received during the period
rxRateKbps	Receive data rate in kilobits per second during the period
newAssoc	Number of newly associated clients during the period
txMgmtFrames_r	Total number of management frames transmitted during the period
bssid	BSSID of the WLAN
txMgmtBytes_r	Total number of management bytes transmitted during the period
ap	MAC address of the AP
failedAssoc	Number of clients that failed to associate with the AP during the period
channel	Radio channel that the AP is using

### AP Time Radio Statistics

The default file name format depends on the time period specified for uploading the statistics file:

- If the statistics file is exported daily:  
`statsAPTimeRadioDay_YYYY_MM_DD_hh_mm_ss_ms.csv`
- If the statistics file is exported hourly:  
`statsAPTimeRadioHour_YYYY_MM_DD_hh_mm_ss_ms.csv` where `ms` stands for three-digit milliseconds.

The following table lists the attributes in the AP time radio statistics file

**Table 34: Attributes in the AP time radio statistics file**

Column Name	Description
key	ID assigned to the AP
airtime	Total airtime (channel) utilization during the period
minNumClients	Minimum number of concurrently connected clients during the period
airtimeB	Busy airtime (channel) utilization during the period
txBytes_r	Total number of bytes transmitted during the period
rxFrames_r	Total number of data frames received during the period
newAssoc	Number of newly associated clients during the period
timestamp	Data aggregation time
txFrames_r	Total number of data frames transmitted during the period

Column Name	Description
rxBytes_r	Total number of bytes received during the period
airtimeRx	Total receiving airtime (channel) utilization during the period
avgNumClients	Average number of concurrently connected clients during the period
airtimeTx	Total transmitting airtime (channel) utilization during the period
radiold	Identifies the specific radio used by the AP
failedAssoc	Number of failed associated clients during the period
maxNumClients	Maximum number of concurrently connected clients during the period
phyError	Number of PHY errors during the period

### AP Time WLAN Statistics

The default file name format depends on the time period specified for uploading the statistics file:

- If the statistics file is exported daily:  
`statsAPTTimeWlanDay_YYYY_MM_DD_hh_mm_ss_ms.csv`
- If the statistics file is exported hourly:  
`statsAPTTimeWlanHour_YYYY_MM_DD_hh_mm_ss_ms.csv` where `ms` stands for three-digit milliseconds.

The following table lists the attributes in the AP WLAN statistics file

**Table 35: Attributes in the AP time WLAN statistics files**

Field name	Description
key	MAC address of the AP
minNumClients	Minimum number of concurrently connected clients during the period
txFail_r	Total number of packets that failed transmission during the period
wlanId	Identifies the specific WLAN ID on the AP
txBytes_r	Total number of bytes transmitted during the period
rxFrames_r	Total number of data frames received during the period
txRateKbps	Transmit data rate in kilobits per second during the period
newAssoc	Number of newly associated clients during the period
timeStamp	Data aggregation time

Field name	Description
rxRateKbps	Receive data rate in kilobits per second during the period
txFrames_r	Total number of data frames transmitted during the period
bssid	BSSID of the WLAN
wsgWlanId	Identified the WLAN ID in the controller system
rxBytes_r	Total number of bytes received during the period
avgNumClients	Average number of concurrently connected clients during the period
ssid	SSID of the WLAN
failedAssoc	Number of clients that failed to associate with the WLAN during the period
maxNumClients	Maximum number of concurrently connected clients during the period
radioid	The radio on the AP used to provide the WLAN service. Possible values include 0 (2.4Ghz radio) and 1 (5GHz radio).
tenantId	ID of the MVNO account

## Control Plane Statistics

The control plane statistics file contains detailed general information about the control plane.

- If the control plane statistics file is exported daily:  
`statsCBladeSysMonDay_YYYY_MM_DD_hh_mm_ss_ms.csv`
- If the control plane statistics file is exported hourly:  
`statsCBladeSysMonHour_YYYY_MM_DD_hh_mm_ss_ms.csv` where `ms` stands for three-digit milliseconds.

**NOTE:** The term "period" in the following table refers to the time interval (hourly or daily) selected in **Statistics Date Interval** on the web interface.

The following table lists the attributes in the control plane statistics file.

**Table 36: Attributes in the control plane statistics file**

Column Name	Description
key	Control plane ID
bond0_rxBytes	Traffic received (in bytes) on bond0
eth1_txBpsMin	Minimum transmitted throughput (in bits per second) on eth1
eth1_txPackets	Number of packets transmitted on eth1
eth2_txBytes	Transmitted traffic (in bytes) on eth2

Column Name	Description
eth0_rxBps	Received throughput (in bits per second) on eth0
bond1_rxBpsMin	Minimum received throughput (in bits per second) on bond1
eth3_rxBps	Received throughput (in bits per second) on eth3
bond1_rxBpsMax	Maximum received throughput (in bits per second) on bond1
eth0_txBps	Transmitted throughput (in bits per second) on eth0
bond0_txBpsMin	Minimum transmitted throughput (in bits per second) on bond0
eth1_txBpsMax	Maximum transmitted throughput (in bits per second) on eth1
eth5_rxBps	Received throughput (in bits per second) on eth5
bond1_rxDropped	Dropped received packets on bond1
eth3_rxBpsMin	Minimum received throughput (in bits per second) on eth3
eth2_txBpsMax	Maximum transmitted throughput (bps) on eth2
eth5_txBps	Transmitted throughput (bps) on eth5
eth5_txDropped	Dropped transmitted packet on eth5
eth4_rxBpsMin	Minimum transmitted throughput (bps) on eth4
eth0_txPackets	Transmitted packet count on eth0
eth4_rxBpsMax	Maximum received throughput (bps) on eth4
eth5_rxPackets	Received packet count on eth5
eth3_txBps	Transmitted throughput (bps) on eth3
bond2_rxBps	Received throughput (bps) on bond2
diskFreeMax	Maximum free disk space
eth4_rxDropped	Dropped received packets on eth4
diskFreeMin	Minimum free disk space
eth2_txBpsMin	Minimum transmitted throughput (bps) on eth2
eth5_txBpsMin	Minimum transmitted throughput (bps) on eth5
memoryPercMax	Maximum memory percentage
bond2_rxDropped	Dropped received packet on bond2
memoryPercMin	Minimum memory percentage
eth3_txPackets	Transmitted packet count on eth3



Column Name	Description
eth3_txBytes	Transmitted traffic bytes on eth3
bond0_txBytes	Transmitted traffic bytes on bond0
eth1_rxDropped	Dropped received packets on eth1
eth2_txDropped	Dropped transmitted packet on eth2
eth4_txBpsMin	Minimum transmitted throughput (bps) on eth4
timestamp	UNIX timestamp
eth3_rxDropped	Dropped received packet on eth3
eth4_txBps	Transmitted throughput (bps) on eth4
eth0_rxBpsMax	Maximum received throughput (bps) on eth0
eth1_txDropped	Dropped transmitted packet on eth1
bond1_txPackets	Transmitted packet count on bond1
bond1_rxBps	Received throughput (bps) on bond1
eth0_txDropped	Dropped transmitted packet on eth0
eth4_txBpsMax	Maximum transmitted throughput (bps) on eth4
diskFree	Free disk volume
eth0_rxDropped	Dropped received packets on eth0
bond0_txBpsMax	Maximum transmitted throughput (bps) on bond0
bond0_txBps	Maximum transmitted throughput (bps) on bond0
bond2_txBps	Transmitted throughput (bps) on bond2
eth0_rxBpsMin	Minimum transmitted throughput (bps) on eth0
eth1_rxBps	Received throughput (bps) on eth1
bond2_txBpsMax	Maximum transmitted throughput (bps) on bond2
bond0_txDropped	Dropped transmitted packets on bond0
eth1_rxBpsMax	Maximum received throughput (bps) on eth1
bond2_txBytes	Transmitted traffic bytes on bond2
eth3_rxPackets	Received packet count on eth3
diskTotalMax	Maximum total disk volume
diskTotalMin	Minimum total disk volume
bond2_rxBpsMax	Maximum received throughput (bps) on bond2

Column Name	Description
diskTotal	Maximum total disk volume
eth0_txBytes	Transmitted traffic bytes on eth0
bond0_rxDropped	Dropped received packets on bond0
eth2_rxBpsMax	Maximum received throughput (bps) on eth2
eth4_rxBps	Received throughput (bps) on eth4
bond2_txBpsMin	Minimum transmitted throughput (bps) on bond2
eth5_rxBpsMin	Minimum transmitted throughput (bps) on eth5
eth1_txBytes	Transmitted traffic bytes on eth1
eth5_txPackets	Transmitted packet count on eth5
eth3_rxBytes	Received traffic bytes on eth3
bond1_txDropped	Dropped transmitted packet on bond1
eth5_txBytes	Transmitted traffic bytes on eth5
bond1_rxBytes	Received traffic bytes on bond1
bond2_txDropped	Dropped transmitted packets on bond2
bond0_txPackets	Transmitted packet count on bond0
eth5_rxDropped	Dropped received packets on eth5
eth1_rxBytes	Received traffic bytes on eth1
bond1_txBps	Minimum transmitted throughput (bps) on bond1
eth2_rxBpsMin	Minimum transmitted throughput (bps) on eth2
eth3_txBpsMin	Minimum transmitted throughput (bps) on eth3
eth5_txBpsMax	Maximum transmitted throughput (bps) on eth5
cpuPercMin	Minimum CPU usage percentage
bond0_rxBps	Received throughput (bps) on bond0
eth5_rxBpsMax	Maximum received throughput (bps) on eth5
bond0_rxBpsMin	Minimum transmitted throughput (bps) on bond0
eth0_txBpsMax	Maximum transmitted throughput (bps) on eth0
memoryPerc	Memory usage percent
eth1_rxBpsMin	Minimum transmitted throughput (bps) on eth1
bond2_txPackets	Transmitted packet count on bond2
eth2_rxBytes	Received traffic bytes on eth2

Column Name	Description
eth4_txPackets	Transmitted packet count on eth4
eth4_txDropped	Dropped transmitted packet on eth4
eth2_rxDropped	Dropped received packet on eth2
cpuPerc	CPU usage percent
bond1_txBytes	Transmitted traffic bytes on bond1
bond1_rxPackets	Received packet count on bond1
bond0_rxPackets	Received packet count on bond0
eth5_rxBytes	Received traffic bytes on eth5
eth1_rxPackets	Received packet count on eth1
eth0_rxPackets	Received packet count on eth0
cpuPercMax	Maximum CPU usage percentage
eth2_txPackets	Transmitted packet count on eth2
eth4_txBytes	Transmitted traffic bytes on eth4
eth3_rxBpsMax	Maximum received throughput (bps) on eth3
eth4_rxPackets	Received packet count on eth4
bond1_txBpsMin	Minimum transmitted throughput (bps) on bond1
bond0_rxBpsMax	Maximum received throughput (bps) on bond0
eth4_rxBytes	Received traffic bytes on eth4
bond1_txBpsMax	Maximum transmitted throughput (bps) on bond1
eth0_txBpsMin	Minimum transmitted throughput (bps) on eth0
bond2_rxBytes	Received traffic bytes on bond2
eth2_rxBps	Received throughput (bps) on eth2
eth2_rxPackets	Received packet count on eth2
eth2_txBps	Transmitted throughput (bps) on eth2
eth3_txBpsMax	Maximum transmitted throughput (bps) on eth3
eth0_rxBytes	Received traffic bytes on eth0
eth3_txDropped	Dropped transmitted packet on eth3
bond2_rxBpsMin	Minimum transmitted throughput (bps) on bond2
eth1_txBps	Transmitted throughput (bps) on eth1
bond2_rxPackets	Received packet count on bond2

## Data Plane Statistics

Data plane statistics describe general information about the data plane.

The default data plane statistic file name format is: `dp_YYYY_MM_DD_hh_mm_ss_ms.csv` where `ms` stands for three-digit milliseconds. The following table lists the data plane statistical attributes.

**Table 37: Attributes in the data plane statistics file**

Column	Description
key	MAC address of the data plane
bladeld	Data plane ID
name	Name of the data plane
model	Model of the data plane
serialNumber	Serial number of the data plane
fwVersion	Current firmware version of the data plane
uptime	Number of minutes elapsed since the data plane was last rebooted
chassisID	Data plane associated with the control plane's MAC address
ip	IP address assigned to the data plane
creationTime	Timestamp when the data plane connected to the controller
lastSeen	Timestamp of the data plane's latest connection

## Data Plane Ethernet Port Statistics

Data plane Ethernet port statistics describe traffic related information on the data plane.

The default data plane statistic file name format is: `dpEthPortStatistics_YYYY_MM_DD_hh_mm_ss_ms.csv` where `ms` stands for three-digit milliseconds.

The following table lists the attributes in the data plane Ethernet port statistics file

**Table 38: Attributes in the data plane Ethernet port statistics file**

Column	Description
dBladeld	MAC address of the data plane
portId	Data plane port ID (either 1 or 2)
timeIntervallnMillis	Unix timestamp when these statistics were collected. These statistics are collected at 15-minute intervals (for example, 10:00, 10:15, 10:30).
txRate	The rate at which the data plane was transmitting data at the time the controller generated this report

Column	Description
rxRate	The rate at which the data plane was receiving data at the time the controller generated this report
txPkts	Incremental packet count transmitted during the 15-minute interval
rxPkts	Incremental packet count received during the 15-minute interval
txDrops	Incremental transmitted packet count dropped during the 15-minute interval
rxDrops	Incremental received packet count dropped during the 15-minute interval
txBytes	Incremental bytes transmitted during the 15-minute interval
rxBytes	Incremental bytes received during the 15-minute interval

### AP SoftGRE Tunnel Statistics

AP SoftGRE tunnel statistics describe SoftGRE tunnel-related information.

The default AP SoftGRE tunnel statistics file name format is:

`statsAPSoftGRETunnel_YYYY_MM_DD_hh_mm_ss_ms.csv` where `ms` stands for three-digit milliseconds.

**Table 39: Attributes in the AP SoftGRE tunnel statistics file**

Column	Description
gw	IP address or FQDN of the SoftGRE gateway
apMac	MAC address of the AP
apIpAddress	IP address of the AP
timeIntervallnMillis	Unix timestamp when these statistics were collected. These statistics are collected at 15-minute intervals (for example, 10:00, 10:15, 10:30).
accessType	This value is always "SoftGRE."
zoneId	Zone UUID
txPkts	TX packet count of GRE interface
txBytes	TX byte count of GRE interface
rxPkts	RX packet count of GRE interface
rxBytes	RX byte count of GRE interface
txErrPkts	TX error packet count of GRE interface
rxErrPkts	RX error packet count of GRE interface

Column	Description
txDropPkts	TX drop packet count of GRE interface
rxDropPkts	RX drop packet count of GRE interface
txFragPkts	Oversized packet count
cICMP	ICMP count
cNonICMP	No-reply ICMP count
cDisconnect	Disconnect count

### SoftGRE Gateway Statistics

The default file name format depends on the time period specified for uploading the statistics file.

- If the statistics file is exported daily:  
`statsSoftGREGatewayDay_YYYY_MM_DD_hh_mm_ss_ms.csv`
- If the statistics file is exported hourly:  
`statsSoftGREGatewayHour_YYYY_MM_DD_hh_mm_ss_ms.csv` where `ms` stands for three-digit milliseconds.

The following table lists the attributes in the SoftGRE gateway statistics file.

**Table 40: Attributes in the SoftGRE gateway statistics files**

Column Name	Description
gw	IP address or FQDN of the SoftGRE gateway
txPkts	MAC address of the AP
txBytes	IP address of the AP
rxPkts	Unix timestamp when these statistics were collected. These statistics are collected at 15-minute intervals (for example, 10:00, 10:15, 10:30).
rxBytes	This value is always "SoftGRE."
txErrPkts	Zone UUID
rxErrPkts	TX packet count of GRE interface
txDropPkts	TX byte count of GRE interface
rxDropPkts	RX packet count of GRE interface
txFragPkts	RX byte count of GRE interface
cICMP	TX Error packet count of GRE interface
cNonICMP	RX Error packet count of GRE interface
cDisconnect	TX Drop packet count of GRE interface

## Tenant Time Radio Statistics

The default file name format depends on the time period specified for uploading the statistics file:

- If the statistics file is exported daily:  
`statsTenantTimeRadioDay_YYYY_MM_DD_hh_mm_ss_ms.csv`
- If the statistics file is exported hourly:  
`statsTenantTimeRadioHour_YYYY_MM_DD_hh_mm_ss_ms.csv` where `ms` stands for three-digit milliseconds.

The following table lists the attributes in the tenant time radio statistics file.

**Table 41: Attributes in the tenant time radio statistics file**

Column Name	Description
key	Tenant identity
rxDataFrames_r	Total number of data frames received during the period
minNumClients	Minimum number of connected clients (concurrent) during the period
txDataFrames_r	Total number of data frames transmitted during the period
txBytes_r	Total number of bytes transmitted during the period
txRateKbps	Transmitted data rate expressed in kilobits per second for the period
rxMgmtFrames_r	Total number of management frames received during the period
timestamp	Data aggregation time
txFrames_r	Total number of data frames transmitted during the period
rxBytes_r	Total number of bytes received during the period
avgNumClients	Average number of connected clients (concurrent) during the period
txDataBytes_r	Total number of data bytes transmitted during the period
radioid	Denotes the specific radio within the AP
maxNumClients	Maximum number of connected clients (concurrent) during the period
rxMgmtBytes_r	Total number of management bytes received during the period
rxDataBytes_r	Total number of data bytes received during the period
rxFrames_r	Total number of data frames received during the period
rxRateKbps	Received data rate expressed in kilobits per second for the period

Column Name	Description
newAssoc	Number of newly associated clients during the period
txMgmtFrames_r	Total number of management frames transmitted during the period
txMgmtBytes_r	Total number of management bytes transmitted during the period
ap	MAC address of the AP
failedAssoc	Number of clients that failed to associate during the period
channel	Radio channel that the AP is using

### Tenant Time WLAN Statistics

The default file name format depends on the time period specified for uploading the statistics file.

- If the statistics file is exported daily:  
`statsTenantTimeWlanDay_YYYY_MM_DD_hh_mm_ss_ms.csv`
- If the statistics file is exported hourly:  
`statsTenantTimeWlanHour_YYYY_MM_DD_hh_mm_ss_ms.csv` where `ms` stands for three-digit milliseconds.

The following table lists the attributes in the tenant time WLAN statistics file.

**Table 42: Attributes in the tenant time WLAN statistics**

Column Name	Description
key	Tenant identity
rxDataFrames_r	Total number of data frames received during the period
minNumClients	Minimum number of connected clients (concurrent) during the period
txDataFrames_r	Total number of data frames transmitted during the period
txBytes_r	Total number of bytes transmitted during the period
txRateKbps	Transmitted data rate expressed in kilobits per second for the period
rxMgmtFrames_r	Total number of management frames received during the period
timestamp	Data aggregation time
txFrames_r	Total number of data frames transmitted during the period
wsgWlanId	Represents the WLAN in the controller system
rxBytes_r	Total number of bytes received during the period



Column Name	Description
avgNumClients	Average number of connected clients (concurrent) during the period
txDataBytes_r	Total number of data bytes transmitted during the period
radiold	Denotes the specific radio on the AP
ssid	SSID string of the WLAN
maxNumClients	Maximum number of connected clients (concurrent) during the period
rxMgmtBytes_r	Total number of management bytes received during the period
rxDataBytes_r	Total number of data bytes received during the period
wlanId	Denotes the specific WLAN on the AP
rxFrames_r	Total number of data frames received during the period
rxRateKbps	Received data rate expressed in kilobits per second for the period
newAssoc	Number of newly associated clients during the period
txMgmtFrames_r	Total number of management frames transmitted during the period
bssid	BSSID string of the WLAN
txMgmtBytes_r	Total number of management bytes transmitted during the period
zoneUUID	Zone identity
ap	MAC address of the AP
failedAssoc	Number of clients that failed to associate during the period
channel	Radio channel that the AP is using

## Tenant Zone Statistics

The default file name format depends on the time period specified for uploading the statistics file.

- If the statistics file is exported daily:  
`statsTenantZoneDay_YYYY_MM_DD_hh_mm_ss_ms.csv`
- If the statistics file is exported hourly:  
`statsTenantZoneHour_YYYY_MM_DD_hh_mm_ss_ms.csv` where `ms` stands for three-digit milliseconds.

The following table lists the attributes in the tenant zone statistics file.

**Table 43: Attributes in the tenant zone statistics**

Column Name	Description
key	Tenant identity
rxDataFrames_r	Total number of data frames received during the period
minNumClients	Minimum number of connected clients (concurrent) during the period
txDataFrames_r	Total number of data frames transmitted during the period
txBytes_r	Total number of bytes transmitted during the period
txRateKbps	Transmitted data rate expressed in kilobits per second for the period
rxMgmtFrames_r	Total number of management frames received during the period
timestamp	Data aggregation time
txFrames_r	Total number of data frames transmitted during the period
wsgWlanId	Represents the WLAN in the controller system
rxBytes_r	Total number of bytes received during the period
avgNumClients	Average number of connected clients (concurrent) during the period
txDataBytes_r	Total number of data bytes transmitted during the period
ssid	SSID string of the WLAN
maxNumClients	Maximum number of connected clients (concurrent) during the period
rxMgmtBytes_r	Total number of management bytes received during the period
rxDataBytes_r	Total number of data bytes received during the period
rxFrames_r	Total number of data frames received during the period
rxRateKbps	Received data rate expressed in kilobits per second for the period
newAssoc	Number of newly associated clients during the period
txMgmtFrames_r	Total number of management frames transmitted during the period
txMgmtBytes_r	Total number of management bytes transmitted during the period
zoneUUID	Zone identity

Column Name	Description
ap	MAC address of the AP
failedAssoc	Number of clients that failed to associate during the period
channel	Radio channel that the AP is using

### Tenant Zone Radio Statistics

The default file name format depends on the time period specified for uploading the statistics file.

- If the statistics file is exported daily:  
`statsTenantZoneRadioDay_YYYY_MM_DD_hh_mm_ss_ms.csv`
- If the statistics file is exported hourly:  
`statsTenantZoneRadioHour_YYYY_MM_DD_hh_mm_ss_ms.csv` where `ms` stands for three-digit milliseconds.

The following table lists the attributes in the tenant zone radio statistics file.

**Table 44: Attributes in the tenant zone radio statistics**

Column Name	Description
key	Tenant identity
rxDataFrames_r	Total number of data frames received during the period
minNumClients	Minimum number of connected clients (concurrent) during the period
txDataFrames_r	Total number of data frames transmitted during the period
txBytes_r	Total number of bytes transmitted during the period
txRateKbps	Transmitted data rate expressed in kilobits per second for the period
rxMgmtFrames_r	Total number of management frames received during the period
timestamp	Data aggregation time
txFrames_r	Total number of data frames transmitted during the period
rxBytes_r	Total number of bytes received during the period
avgNumClients	Average number of connected clients (concurrent) during the period
txDataBytes_r	Total number of data bytes received during the period
radioId	Denote the specific radio within the AP
maxNumClients	Maximum number of connected clients (concurrent) during the period

Column Name	Description
rxMgmtBytes_r	Total number of management bytes received during the period
rxDataBytes_r	Total number of data bytes received during the period
rxFrames_r	Total number of data frames received during the period
rxRateKbps	Received data rate expressed in kilobits per second for the period
newAssoc	Number of newly associated clients during the period
txMgmtFrames_r	Total number of management frames transmitted during the period
txMgmtBytes_r	Total number of management bytes transmitted during the period
zoneUUID	Zone identity
ap	MAC address of the AP
failedAssoc	Number of failed associated clients during the period
channel	Radio channel that the AP is using

## Tenant Inventory File

The tenant inventory file contains detailed information about each tenant account that has been created on the controller.

The default tenant inventory file name format

is:tenant\_YYYY\_MM\_DD\_hh\_mm\_ss\_ms.csv where ms stands for three-digit milliseconds.

The following table lists the tenant inventory statistical attributes.

**Table 45: Attributes in the tenant inventory statistics**

Column Name	Description
key	Tenant identity
Phone	Phone number of the tenant
adminUUID	UUID of the creator
createdDatetime	Unix timestamp when the tenant was created
city	City where the tenant is located
address	Address of the tenant
email	Email address of the tenant
description	Description of the account
modifiedDatetime	Unix timestamp when the account was last updated

Column Name	Description
name	Name of the tenant

## Appendix

# C

## AP-SCG/SZ/vSZ/vSZ-D Communication

The table below lists the ports that must be opened in the network firewall to ensure that the SCG/vSZ-D/SZ/vSZ (controller), managed APs, and RADIUS servers can communicate with each other successfully.

**Table 46: Ports to open for AP-SCG/SZ/vSZ/vSZ-D communication**

Port Number	Layer 4 Protocol	From (Sender)	To (Listener)	Configurable from Web Interface?	Purpose
21	TCP	AP	vSZ control plane	Yes	FTP upload of reports, statistics, and configuration backups
22	TCP	<ul style="list-style-type: none"> <li>AP</li> <li>vSZ-D</li> </ul>	vSZ control plane	No	SSH tunnel
49	TCP	TACACS+ server	vSZ control plane	Yes	TACACS+ based authentication of controller administrators
91 and 11443	TCP	AP	vSZ control plane	No	AP firmware upgrade
123	UDP	AP	vSZ control plane	No	NTP sync up Not required in 2.1.2, 2.1.3, 2.5.1, 2.6, 3.0 Required in 1.x, 2.1, 2.1.1, 2.5
443	TCP	<ul style="list-style-type: none"> <li>AP</li> <li>vSZ-D</li> </ul>	vSZ control plane	No	Access to the SCG/vSZ/SZ control plane over secure HTTPS
6868	TCP	vSZ-D	vSZ	No	Internal communication port

Port Number	Layer 4 Protocol	From (Sender)	To (Listener)	Configurable from Web Interface?	Purpose
8443	TCP	Any	vSZ management plane	No	Access to the SCG/vSZ/SZ web interface via HTTPS
23232	TCP	AP	SCG (data plane)	No	GRE tunnel  <b>NOTE:</b> Only applicable to SCG.
23233	UDP and TCP	AP	Data plane	Yes	GRE tunnel (required only when tunnel mode is GRE over UDP)  <b>NOTE:</b> On the vSZ-D, this port is used for both data and control in both UDP and TCP.
12222/12223	UDP	AP	vSZ control plane	No	LWAPP discovery  <b>NOTE:</b>  If your AP is within the same subnet as the controller, disable nat-ip-translation to establish a connection between the AP and the controller so that AP firmware upgrade progresses.  If your AP is on the side of the NAT server and if the NAT server does not support PASV-Mode FTP, enable nat-ip-translation. If the NAT server supports PASV-Mode FTP, then disable nat-ip-translation for AP firmware upgrade to progress

Port Number	Layer 4 Protocol	From (Sender)	To (Listener)	Configurable from Web Interface?	Purpose
1812/1813	UDP	AP	Radius servers (s)	Yes	AAA authentication and accounting
8022	No (SSH)	Any	Management interface	Yes	CLI (Command Line Interface) access to the vSZ
8090	TCP	Any	vSZ control plane	No	Allows unauthorized UEs to browse to an HTTP website
8099	TCP	Any	vSZ control plane	No	Allows unauthorized UEs to browse to an HTTPS website
8100	TCP	Any	vSZ control plane	No	Allows unauthorized UEs to browse using a proxy UE
8111	TCP	Any	vSZ control plane	No	Allows authorized UEs to browse using a proxy UE
9080	HTTP	Any	vSZ control plane	No	Northbound Portal Interface for hotspots
9443	HTTPS	Any	vSZ control plane	No	Northbound Portal Interface for hotspots
9998	TCP	Any	vSZ control plane	No	Hotspot WISPr subscriber portal login/logout over HTTPS
3333	TCP	Controller	License server	No	Local license server
443	HTTPS	Controller	License server	No	Cloud license server
9996	TCP	Client	Controller interface	No	HotSpot 2.0 portal for onboarding and remediation
9999	TCP	Client	Controller interface	No	HotSpot 2.0 trust CA verification
8200	TCP	Client	Controller interface	No	HotSpot 2.0 Oauth in HTTP
8222	TCP	Client	Controller interface	No	HotSpot 2.0 Oauth in HTTPS



**NOTE:** The destination interfaces are meant for three interface deployments. In a single interface deployment, all the destination ports must be forwarded to the combined management/control interface IP address.

**NOTE:** Communication between APs is not possible across NAT servers.

---

## Appendix

# D

---

## SoftGRE Support

In this chapter:

- [Overview of SoftGRE Support](#)

This appendix describes the SoftGRE support that the controller provides and the supported deployment topology.

### Overview of SoftGRE Support

There are numerous equipment vendors serving the service provider market today. Among these vendors, the more prominent ones include Alcatel-Lucent (ALU), Ericsson, NSN, Huawei and Cisco. Most of these vendors support different tunneling and mobility management protocols at their packet gateways.

Since most (if not all) of these equipment vendors do not develop access points themselves, they are publishing SoftGRE specifications to enable access point vendors (such as Ruckus Wireless) to support SoftGRE on their devices.

### Supported Deployment Scenario

The controller supports SoftGRE in the deployment scenario wherein the controller functions purely as an AP controller. In this deployment topology, the controller only manages the Ruckus Wireless APs and does not perform other functions. All control paths (RADIUS Authentication/Accounting) and data paths (SoftGRE tunnel) terminate on the third party WLAN gateway.

If 802.1x authentication is used, the RADIUS server will be outside of the SoftGRE tunnel. If open, WISPr-based authentication is used, the portal or redirect function will be on the edge router or northbound of the edge router. The controller does not play any role in the control and data path functions (see [Figure 255: The controller as a pure AP controller](#) on page 435).

# Direct AP to GW Tunnel Solution

## Distributed WAG & Centralized WAC

### SCG-200 <-> AP Mgmt & 7750 <-> WAG Authentication & Data Plane AP

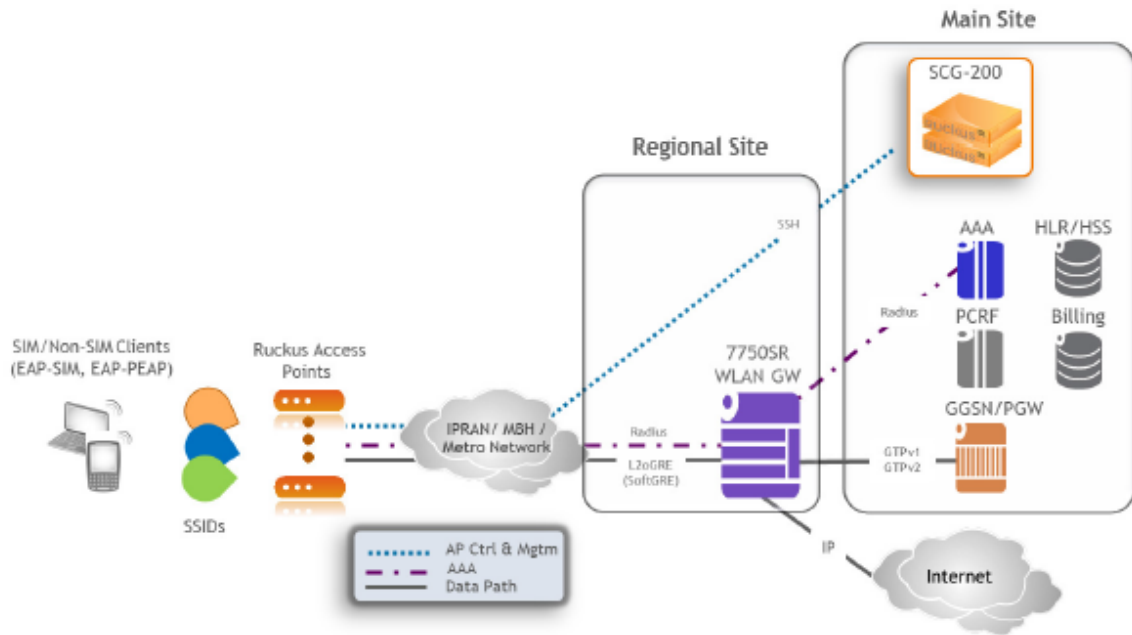


Figure 255: The controller as a pure AP controller

## SoftGRE Packet Format

Configuring SoftGRE on page 436 displays a screen shot of SoftGRE packet capture data.

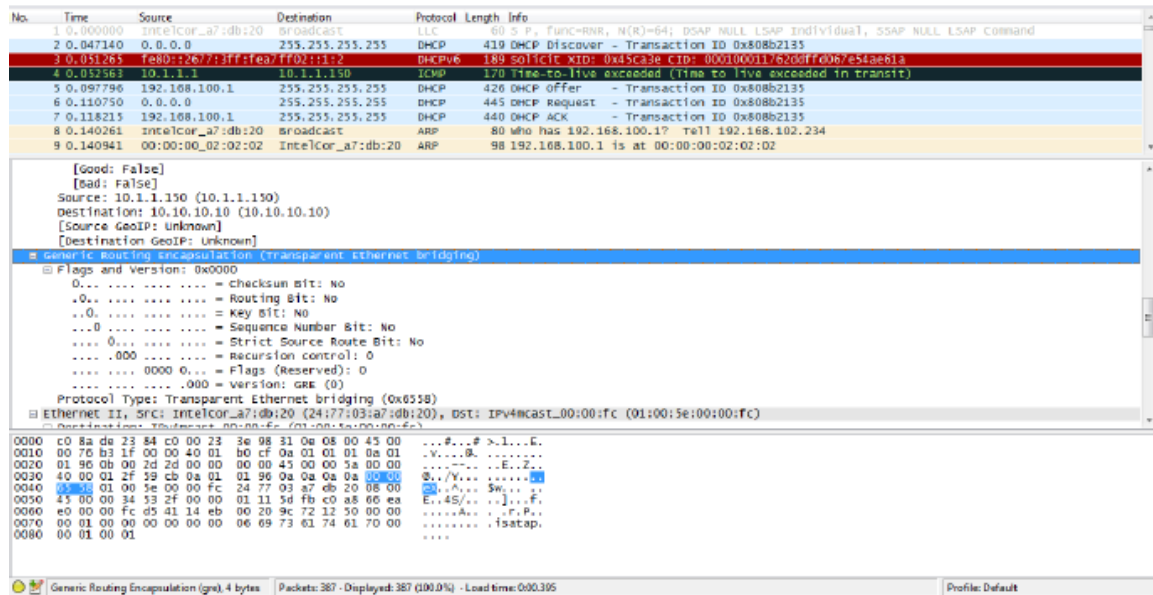


Figure 256: Example of SoftGRE packet format

## Configuring SoftGRE

This section describes the configuration options for the SoftGRE feature.

### Creating an AP Zone That Supports SoftGRE

For information on how to create an AP zone that supports SoftGRE tunneling, see [Working with AP Zones](#) on page 31.

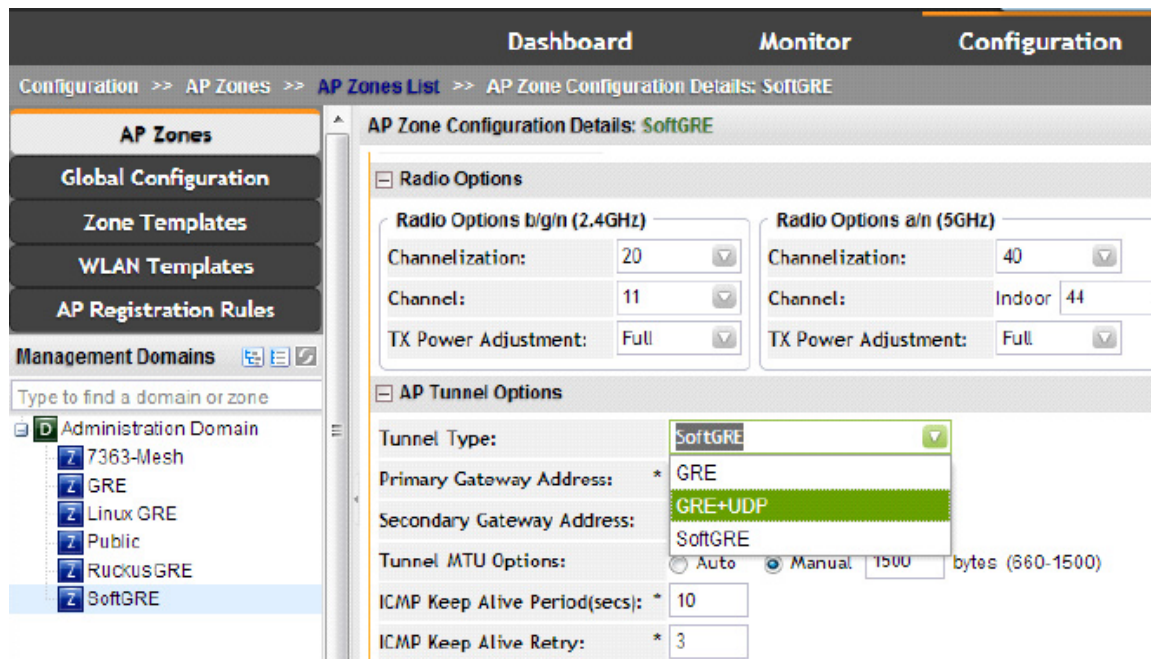
**NOTE:** MVNO accounts are currently unsupported by SoftGRE tunnels. If you create an MVNO account and assign an AP zone that is using a SoftGRE tunnel, an error message appears.

### Changing the Tunnel Type from SoftGRE

If no tunneled WLANs exist in the zone, you can change the tunnel type from SoftGRE to GRE or GRE + UDP.

Follow these steps to change the tunnel type from SoftGRE.

1. Go to **Configuration > AP Zones** page.
2. On the **AP Zone List** page, click the name of the zone that you want to edit.  
 The **Zone Configuration** page appears.
3. Click **Edit**.
4. Scroll down to the **AP GRE Tunnel Option** section.
5. In **AP Tunnel Type**, select the tunnel type to which you want to change from SoftGRE.
6. Click **Apply**.



**Figure 257: Change the tunnel type from SoftGRE to GRE or GRE+UDP**

If you attempt to change the tunnel type when a tunneled WLAN exists within the zone, the following error message appears: Unable to update the configuration of the AP

zone. Reason: It is disallowed to change the tunnel type, because it has tunneled WLAN.

## Monitoring SoftGRE

You can use the Monitor pages to view AP SoftGRE statistics. This section describes:

### Checking the AP Tunnel Type of a Zone

Follow these steps to check if a zone is using SoftGRE tunneling.

1. Go to **Monitor > AP Zone**.
2. In the **Administration Domain** tree, click each AP zone name to display their zone information summary.
3. In the **General Information** section, check the value for Tunnel.

If the value shown is SoftGRE, this indicates that the zone is using SoftGRE tunneling.

The screenshot shows the 'AP Zone: B52\_Testing' details page. The 'General Information' section contains the following data:

General Information		Zone Summary
Zone Name	B52_Testing	# of APs
Description	Created via zone template [B50_Testing Template]	# of APs by MK
Created By	admin	# of WLANs
Updated On	2013/08/20 04:10:11	# of Clients
Firmware Version	1.1.2.7.36	# of Alarms
Country Code	United States	# of Events
Mesh	Disabled	
<b>Tunnel</b>	<b>SoftGRE</b>	
Switchover Cluster	Disable	

The 'Tunnel' row is highlighted with a red box. Below the general information is the 'Outstanding Alarms' section, which includes a search criteria filter: 'AP Zone - "B52\_Testing" && Status - "Outstanding"'.

Figure 258: Check the value for "Tunnel" to verify that a zone is using SoftGRE tunneling

### Viewing SoftGRE Traffic Statistics of an AP

Monitor pages allow you to view AP SoftGRE statistics.

Follow these steps to view the SoftGRE tunnel statistics of an AP that belongs to a zone enabled for SoftGRE

1. Go to **Monitor > Access Points**.
2. In the **Administration Domain** tree, click a zone that is enabled for SoftGRE.

The APs that appear on the **AP List** page are all using SoftGRE tunneling.

3. Click the MAC address of an AP whose SoftGRE traffic statistics you want to view.
4. On the **AP Status** tab, scroll down to the **AP SoftGRE Tunnel Statistics** section to view the AP SoftGRE statistics.

Additional SoftGRE statistics appear in the **AP SoftGRE Control Signaling Statistics** section. [Table 3](#) describes the SoftGRE statistics that appear.

**Figure 259: AP SoftGRE statistics on the Monitor page**

**Table 47: SoftGRE statistics of an AP**

Statistic	Description
Gateway	The IP address of the gateway server
Is Active	<ul style="list-style-type: none"> <li>• Yes, if the gateway is currently active</li> <li>• No, if the gateway is inactive</li> </ul>
Bytes (Tx/Rx)	The number bytes transmitted/received (Tx/Rx) through the SoftGRE tunnel
Packets (Tx/Rx)	The number packets transmitted/received (Tx/Rx) through the SoftGRE tunnel
Error Packets (Tx/Rx)	<p>The number of packets with errors.</p> <p>Tx errors may be caused by any of the following:</p> <ul style="list-style-type: none"> <li>• No routing entry to destination</li> <li>• Invalid routing entry (routing traffic to tunnel interface itself)</li> <li>• Transmission error in core IP layer of Linux</li> </ul> <p>Rx errors may be caused by any of the following:</p> <ul style="list-style-type: none"> <li>• Bad packets received, checksum does not match (remote peer enables CSUM field in GRE header)</li> <li>• Sequence number does not match (remote peer enables SEQ field in GRE header)</li> <li>• SKB error during GRE decapsulation.</li> </ul>
Dropped Packets (Tx/Rx)	<p>The number of packets that have been dropped.</p> <ul style="list-style-type: none"> <li>• Tx dropped packets may be due to insufficient space in the Linux buffer or insufficient memory when allocating extra buffer for GRE encapsulation.</li> <li>• Rx dropped packets may be due to insufficient space in the Linux buffer.</li> </ul>
TX Fragmented Packets	The number of oversized Tx packets.
ICMP Requests	The total number of ICMP requests
Failed ICMP Requests	The total number of failed ICMP requests

You have completed viewing the AP SoftGRE statistics.

This chapter lists the SNMP MIBs, alarms, and events that are related to SoftGRE.

## SoftGRE SNMP MIBs

[Table 48: OIDs related to SoftGRE](#) on page 439 lists the SoftGRE related OIDs.

**Table 48: OIDs related to SoftGRE**

Parent Node	Node Name	OID
ruckusWLANAPInfo	ruckusSCGWLANAPMacAddr	1.3.6.1.4.1.25053.1.3.2.1.1.2.3.1.1
	ruckusSCGWLANAPSoftGREServer	1.3.6.1.4.1.25053.1.3.2.1.1.2.3.1.2
	ruckusSCGWLANAPSoftGREGWAddr	1.3.6.1.4.1.25053.1.3.2.1.1.2.3.1.3
	ruckusSCGWLANAPSoftGREActive	1.3.6.1.4.1.25053.1.3.2.1.1.2.3.1.4
	ruckusSCGWLANAPSoftGRETxPkts	1.3.6.1.4.1.25053.1.3.2.1.1.2.3.1.5
	ruckusSCGWLANAPSoftGRETxBytes	1.3.6.1.4.1.25053.1.3.2.1.1.2.3.1.6
	ruckusSCGWLANAPSoftGRERxPkts	1.3.6.1.4.1.25053.1.3.2.1.1.2.3.1.7
	ruckusSCGWLANAPSoftGRERxBytes	1.3.6.1.4.1.25053.1.3.2.1.1.2.3.1.8
	ruckusSCGWLANAPSoftGRETxPktsErr	1.3.6.1.4.1.25053.1.3.2.1.1.2.3.1.9
	ruckusSCGWLANAPSoftGRERxPktsErr	1.3.6.1.4.1.25053.1.3.2.1.1.2.3.1.10
	ruckusSOGWLANAPSoftGRETxPktsDropped	1.3.6.1.4.1.25053.1.3.2.1.1.2.3.1.11
	ruckusSOGWLANAPSoftGRERxPktsDropped	1.3.6.1.4.1.25053.1.3.2.1.1.2.3.1.12
	ruckusSCGWLANAPSoftGRETxPktsFrag	1.3.6.1.4.1.25053.1.3.2.1.1.2.3.1.13
	ruckusSCGWLANAPSoftGREICMPTotal	1.3.6.1.4.1.25053.1.3.2.1.1.2.3.1.14
	ruckusSOGWLANAPSoftGREICMPNoReply	1.3.6.1.4.1.25053.1.3.2.1.1.2.3.1.15
	ruckusSCGWLANAPSoftGREDisconnect	1.3.6.1.4.1.25053.1.3.2.1.1.2.3.1.16

## SoftGRE Alarms and Events

If there is no downstream traffic in the tunnel, APs that belong to the zone configured for SoftGRE send out-of-band ICMP keep-alive messages (interval is configurable) to the active third party WLAN gateway. If an AP does not receive a response from the active WLAN gateway, it triggers an alarm and it automatically creates a SoftGRE tunnel to the standby WLAN gateway.

If the AP does not receive a response from the standby WLAN gateway either, the AP disconnects all tunneled WLAN services. It continues to send keep-alive messages to both the active WLAN gateway (primary GRE remote peer) and standby WLAN gateway (secondary GRE remote peer). If it receives a response from either WLAN gateway, the AP restores all tunneled WLAN services automatically.

There are four types of events that APs send to the controller:

- Failover from primary GRE remote peer to secondary GRE remote peer

- Failover from secondary GRE remote peer to primary GRE remote peer.
- Tunnel disconnected because both primary and secondary GRE remote peers are unreachable
- Tunnel restored because either primary or secondary GRE remote peer is reachable

For the list of alarms and events related to SoftGRE that APs generate, refer to [SoftGRE Events](#) and [SoftGRE Alarms](#) on page 441.

### SoftGRE Events

SoftGRE related events that APs send to the controller.

Following are the events related to SoftGRE that AP generates.

- apSoftGRE Tunnel Failover PtoS** AP [{apname@apMac}] fails over from primaryGRE [{address}] to secondaryGRE [{address}].  
Code: 611  
Severity:  
Attributes:
- "apMac"="xx:xx:xx:xx:xx:xx"
  - "primaryGRE"="xxx.xxx.xxx.xxx"
  - "secondaryGRE"="xxx.xxx.xxx.xxx"
- apSoftGRE Tunnel Failover StoP** AP [{apname@apMac}] fails over from secondaryGRE [{address}] to primaryGRE [{address}].  
Code: 612  
Severity: Warning  
Attributes:
- "apMac"="xx:xx:xx:xx:xx:xx"
  - "secondaryGRE"="xxx.xxx.xxx.xxx"
  - "primaryGRE"="xxx,xxx.xxx.xxx"
- apSoftGRE Gateway Reachable** AP [{apname@apMac}] is able to reach [{softgreGW}] [{softgreGWAddress}] successfully.  
Code: 613  
Severity: Informational  
Attributes:
- "apMac"="xx:xx:xx:xx:xx:xx"
  - "softgreGW"="primaryGRE"
  - "softgreGWAddress" = "xxx.xxx.xxx.xxx"
- apSoftGRE Gateway Not Reachable** AP [{apname@apMac}] is able to reach [{softgreGW}] [{softgreGWAddress}] successfully.  
Code: 614  
Severity: Critical  
Attributes:
- apMac"="xx:xx:xx:xx:xx:xx"



- "softGREGatewayList"="xxx.xxx.xxx.xxx,  
yyy.yyy.yyy.yyy"

## SoftGRE Alarms

SoftGRE related alarms that APs send to the controller.

Following are the SoftGRE related alarms:

- apSoftGRE Tunnel Failover PtoS** AP[{apname@apMac}] fails over from primaryGRE[{address}] to secondaryGRE[{address}]  
Code: 611  
Default to Trap: true  
Severity: major  
Attributes:
- "apMac"="xx:xx:xx:xx:xx:xx"
  - "primaryGRE"="xxx.xxx.xxx.xxx"
  - "secondaryGRE"="xxx.xxx.xxx.xxx"
- apSoftGRE Tunnel Failover StoP** AP[{apname@apMac}] fails over from secondaryGRE[{address}] to primaryGRE[{address}]  
Code: 612  
Default to Trap: true  
Severity: major  
Attributes:
- "apMac"="xx:xx:xx:xx:xx:xx"
  - "secondaryGRE"="xxx.xxx.xxx.xxx"
  - "primaryGRE"="xxx,xxx.xxx.xxx"
- apSoftGRE Gateway Reachable** AP [{apname@apMac}] is able to reach [{softgreGW}] [{softgreGWAddress}] successfully  
Code: 613  
Default to Trap: true  
Severity: informational  
Attributes:
- "apMac"="xx:xx:xx:xx:xx:xx"
  - "softgreGW"="primaryGRE"
  - "softgreGWAddress"="xxx.xxx.xxx.xxx"
- apSoftGRE Gateway Not Reachable** AP [{apname@apMac}] is unable to reach the following gateways: [{gateway list}]  
Code: 614  
Default to Trap: true  
Severity: major  
Attributes:

- "apMac"="xx:xx:xx:xx:xx:xx"
- "softGREGatewayList"="xxx.xxx.xxx.xxx,  
yyy.yyy.yyy.yyy"

## Replacing Hardware Components

In this chapter:

- [Installing or Replacing Hard Disk Drives](#)

This appendix describes how to replace hardware components (including hard disk drives, power supply units, and system fans) on the controller.

### Installing or Replacing Hard Disk Drives

You can install up to six hot-swappable SAS or SATA hard disk drives on the controller. The drives go into carriers that connect to the SAS/SATA backplane board once the carriers with drives attached are inserted back into the drive bays. The controller ships with six drive carriers.

**CAUTION:** If you install fewer than six hard disk drives, the unused drive bays must contain the empty carriers that ship with the server to maintain proper cooling.

### Ordering a Replacement Hard Disk

To order a replacement hard disk for the controller, contact your Ruckus Wireless sales representative and place an order for FRU part number 902-0188-0000 (Hard Drive, 600GB, 10K RPM, 64MB Cache 2.5 SAS 6Gb/s, Internal).

**CAUTION:** Use only FRU part number 902-0188-0000 as replacement hard disk for the controller. Using other unsupported hard disks will render the controller hardware warranty void.

### Removing the Front Bezel

You must remove the front bezel to add or replace a hard drive in one of the drive bays. It is not necessary to remove the front chassis cover or to power down the system. The hard drives are hot-swappable.

Follow these steps to remove the front bezel of the controller.

You need to remove the front bezel for tasks such as:

- Installing or removing hard disk drives or an SD flash card
- Observing the individual hard disk drive activity/fault indicators
- Replacing the control panel LED/switch board

The server does not have to be powered down just to remove the front bezel.

1. Loosen the captive bezel retention screw on the right side of the bezel (see A in [Figure 6](#)).
2. Rotate the bezel to the left to free it from the pins on the front panel (see B in [Figure 6](#)), and then remove it.

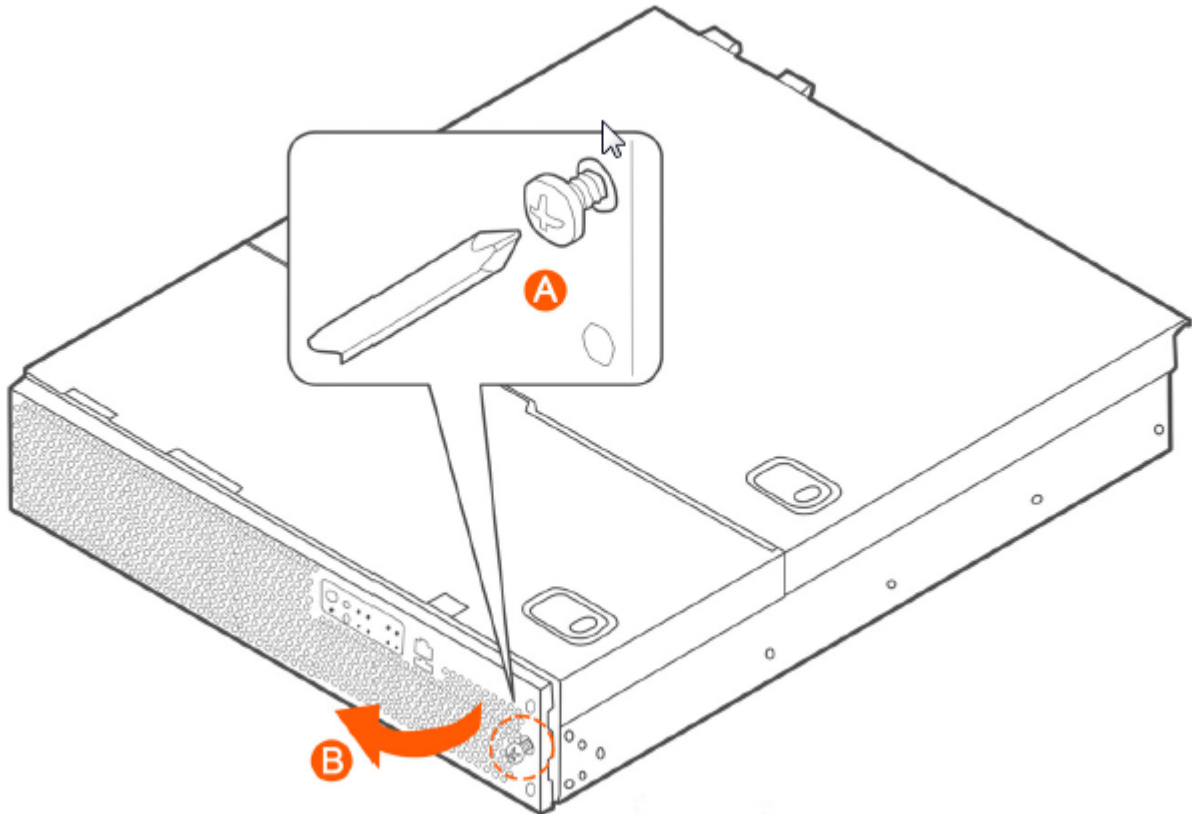


Figure 260: Removing the front bezel

### Removing an HDD Carrier from the Chassis

Follow these steps to remove a hard disk drive carrier from the chassis.

1. Remove the front bezel (see [Removing the Front Bezel](#) on page 443).
2. Select the drive bay where you want to install or replace the drive.  
Drive bay 0 must be used first, then drive bay 1 and so on. The drive bay numbers are printed on the front panel below the drive bays.
3. Remove the drive carrier by pressing the green button to open the lever.  
(See A in [Figure 261: Removing the drive carrier](#) on page 445).
4. Pull the drive carrier out of the chassis.

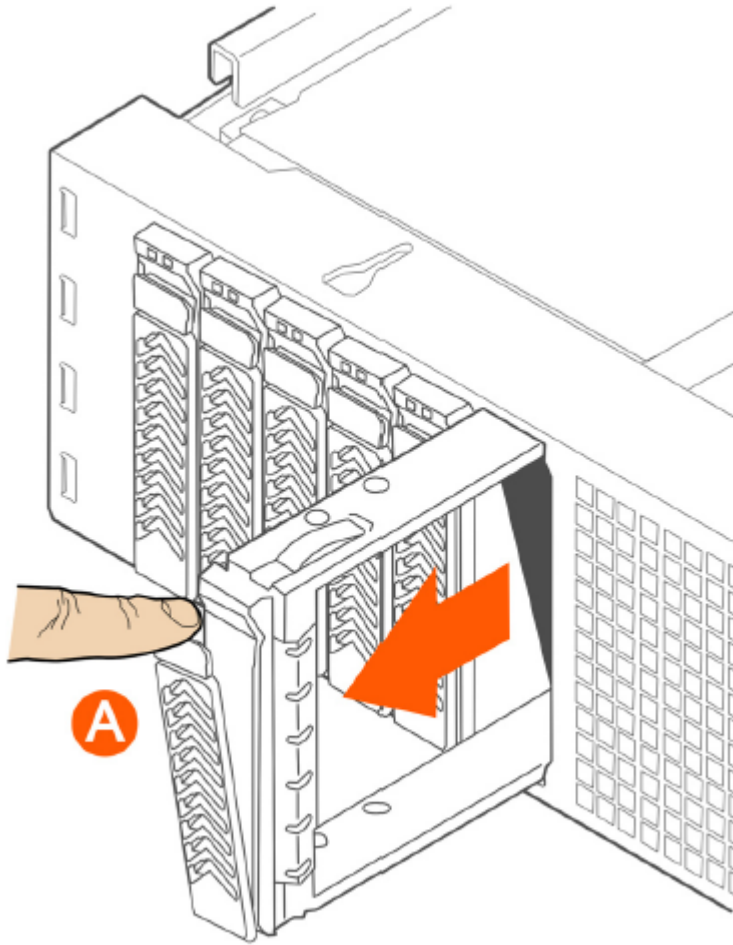
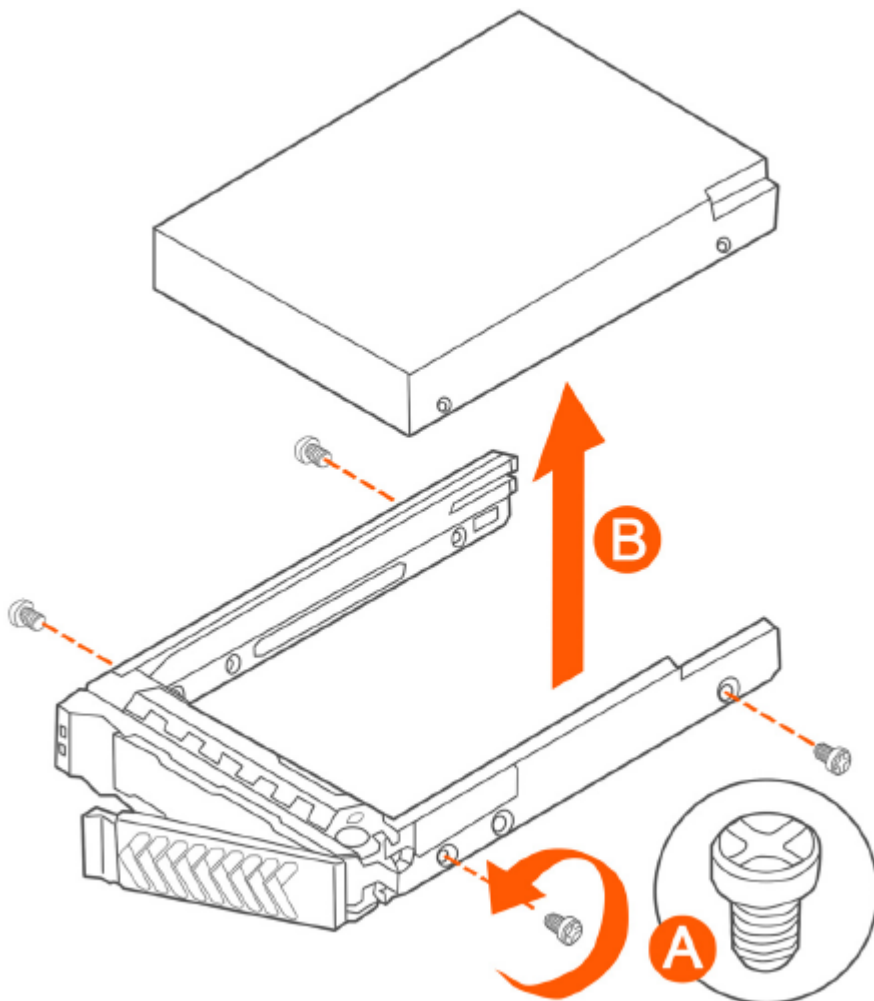


Figure 261: Removing the drive carrier

### Installing a Hard Drive in a Carrier

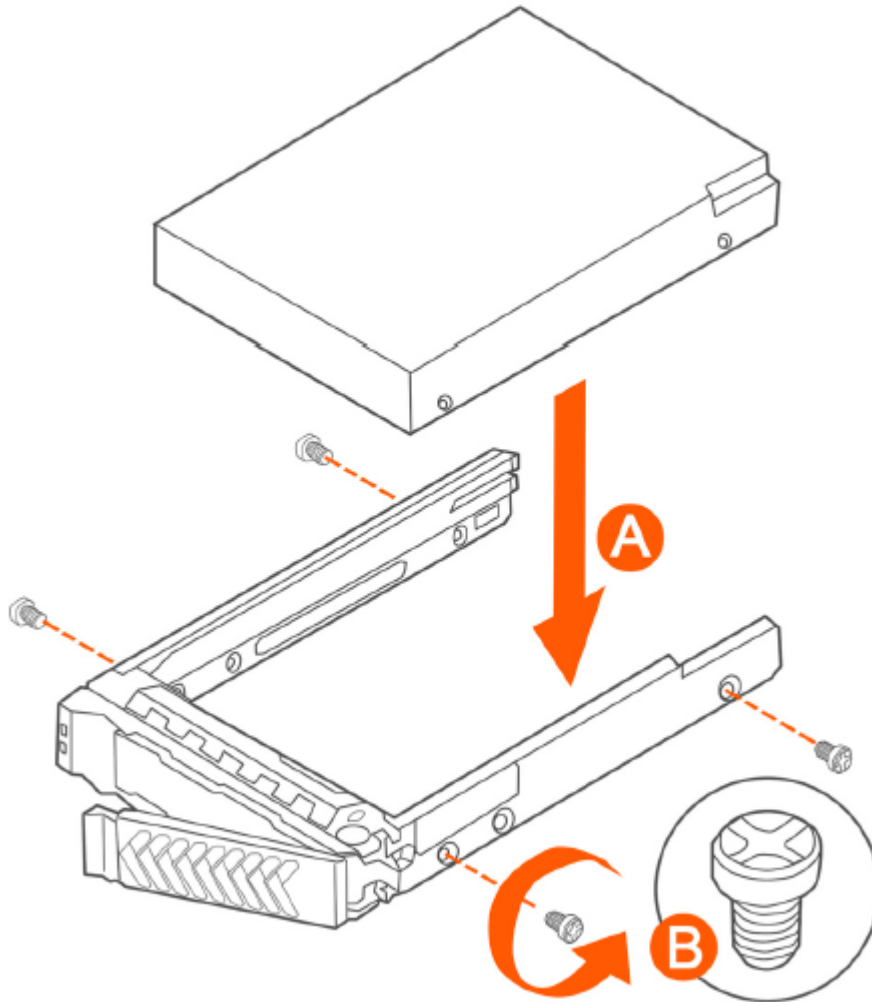
Follow these steps to install a hard drive in a drive carrier.

1. If a drive is already installed (that is, if you are replacing the drive), remove it by unfastening the four screws that attach the drive to the drive carrier (see A in [Figure 262: Removing the hard drive](#) on page 446). Set the screws aside for use with the new drive.
2. Lift the drive out of the carrier (see B in [Figure 262: Removing the hard drive](#) on page 446).



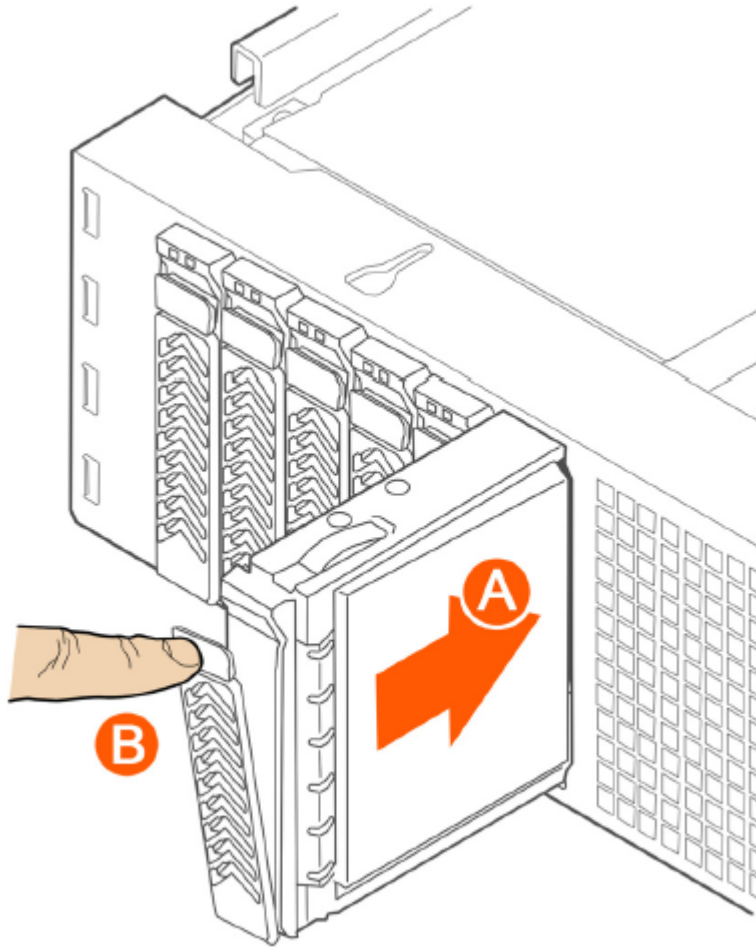
**Figure 262: Removing the hard drive**

3. Install the new drive in the drive carrier (see A in [Figure 263: Installing the hard drive](#) on page 447), and then secure the drive with the four screws that come with the carrier (see B).



**Figure 263: Installing the hard drive**

4. With the drive carrier locking lever fully open, push the hard drive carrier into the drive bay in the chassis until it stops (see A in [Figure 264: Inserting the carrier back into the chassis](#) on page 448).



**Figure 264: Inserting the carrier back into the chassis**

5. Press the locking lever until it snaps shut and secures the drive in the bay.

You have completed installing or replacing the hard drive onto the controller.

**NOTE:** The new hard drive will synchronize automatically with the existing RAID array. During the synchronization process, the HDD LED on the controller will blink amber and green alternately. When the process is complete, the HDD LED will turn off.

### Reinstalling the Front Bezel

Follow these steps to reinstall the front bezel on the controller.

1. Insert the tabs on the left side of the bezel into the slots on the front panel of the chassis.
2. Move the bezel toward the right of the front panel and align it on the front panel pins.
3. Snap the bezel into place and tighten the retention screw to secure it.



## Replacing PSUs

The controller includes two redundant, hot-swappable power supply units (2 AC PSUs or 2 DC PSUs). No chassis components need to be removed to add or replace a PSU.

Follow these steps to remove and replace a PSU.

1. Identify the faulty PSU by looking at the PSU status LED (red indicates PSU failure, green indicates normal operation).
2. Press and hold the green safety lock downward while grasping the PSU handle.
3. Pull outward on the handle, sliding the PSU all the way out of the rear of the machine.
4. Insert the new PSU into the slot and, while holding the green safety lock, slide the PSU into the slot until it locks in place.

The PSU status LED turns green, indicating that the PSU is operating normally.

**NOTE:** If you are installing a DC power supply, there are two threaded studs for chassis enclosure grounding. A 90° standard barrel, two-hole, compression terminal lug with 5/8-inch pitch suitable for a #14-10 AWG conductor must be used for proper safety grounding. A crimping tool may be needed to secure the terminal lug to the grounding cable.

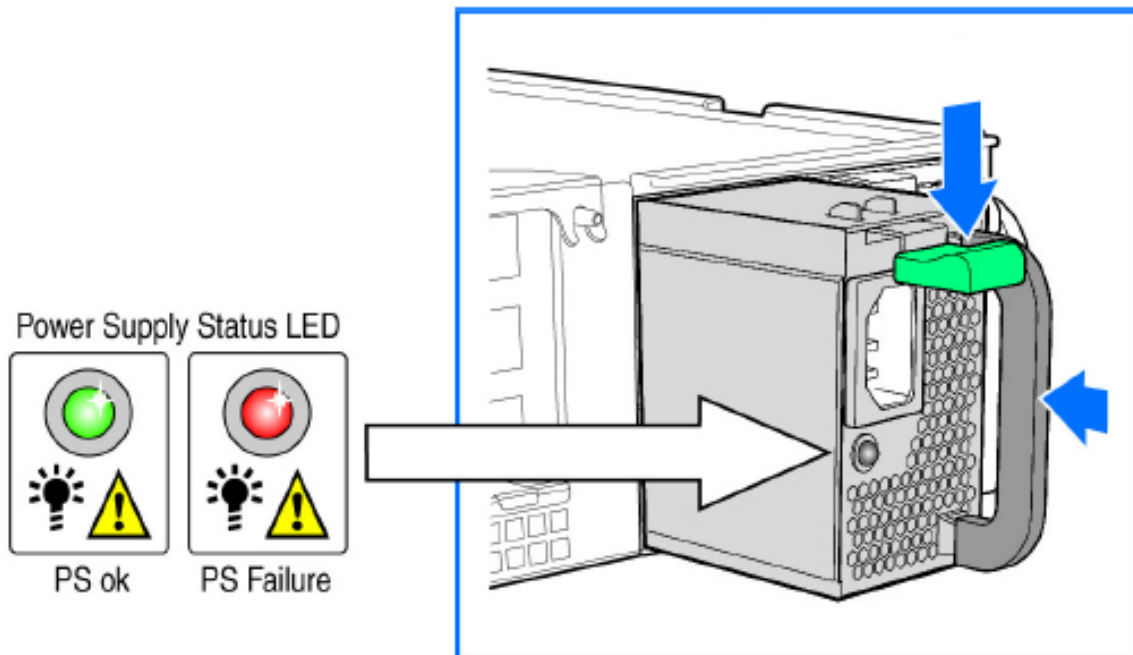


Figure 265: Replacing a PSU

## Replacing System Fans

The controller includes six redundant, hot-swappable system fans (four 80mm fans and two 60mm fans). There are also two fans located inside the power supply units. Redundancy for the two PSU fans is only achieved when both PSUs are installed.

If any of the system fans requires replacement, the replacement procedure is identical.

Electrostatic discharge (ESD) can damage internal components such as printed circuit boards and other parts. Ruckus Wireless recommends that you only perform this procedure with adequate ESD protection. At a minimum, wear an anti-static wrist strap attached to the ESD ground strap attachment on the front panel of the chassis.

Follow these steps to replace a system fan.

1. Open the front chassis cover of the controller. It may be necessary to extend the controller into a maintenance position.
2. Identify the faulty fan. Each fan has a "service required" LED that turns amber when the fan is malfunctioning.
3. Remove the faulty fan by grasping both sides of the fan assembly, using the plastic finger guard on the left side and pulling the fan out of the metal fan enclosure.
4. Slide the replacement fan into the same metal fan enclosure. Use the edges of the metal enclosure to align the fan properly and ensure the power connector is seated properly in the header on the side of the enclosure.
5. Apply firm pressure to fully seat the fan.
6. Verify that the (service required) LED on the top of the fan is not lit.
7. Close the front chassis cover and return the controller to its normal position in the rack, if necessary.

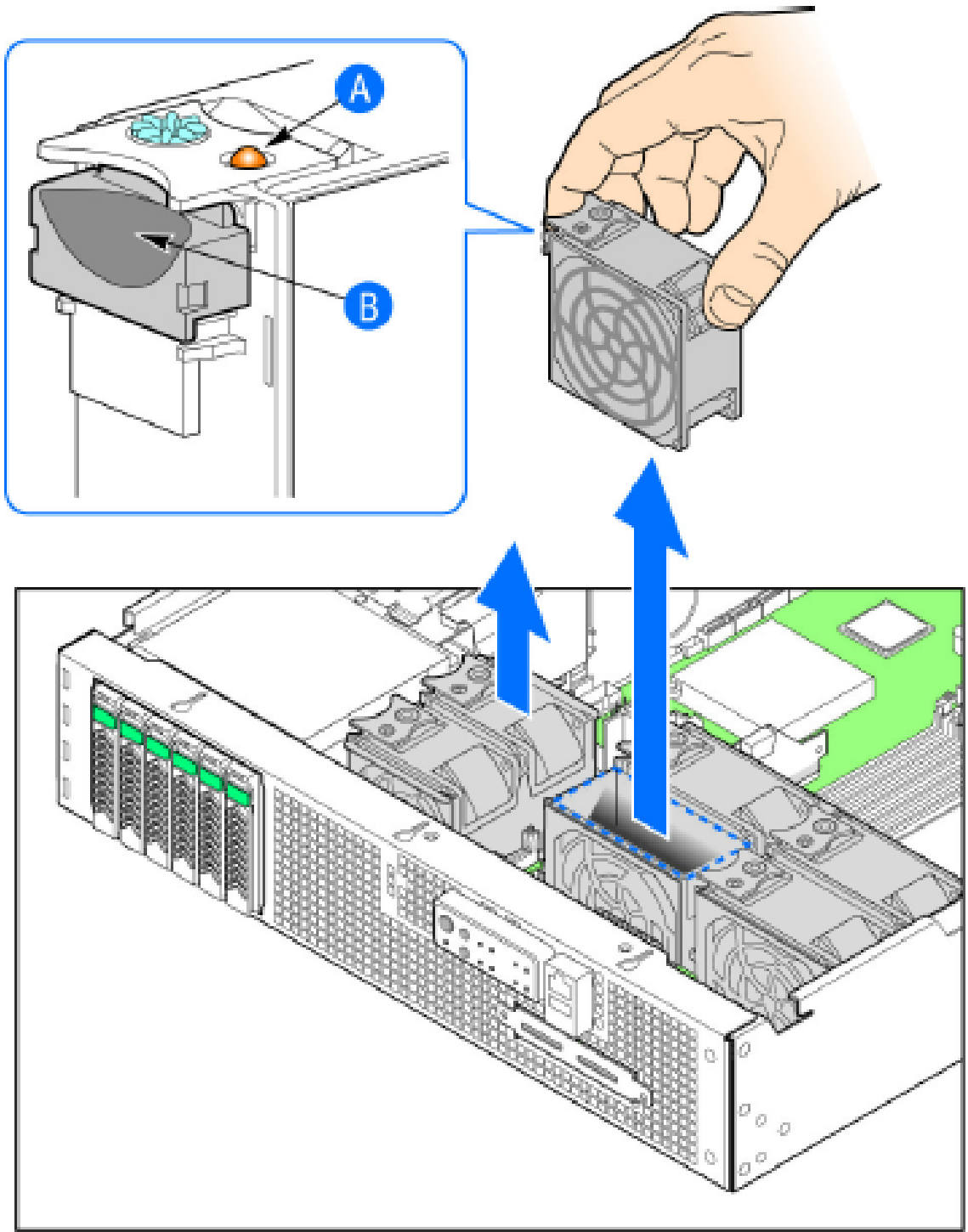


Figure 266: Replacing a system fan

---

## Appendix

# F

---

## Replacing a Controller Node

In this chapter:

- [Backing Up and Restoring the Cluster](#)
- [Backing Up and Restoring Configuration](#)

**NOTE:** The information in this appendix only applies to the SCG-200.

This appendix describes how to back up cluster and configuration data and replace a controller node. Topics include:

The following are required to perform the procedures described in this guide.

1. A remote FTP server with at least 50GB of free disk space. You must create an FTP account (user name and password) before starting these procedures.
2. If you are restoring to a multi node cluster environment, all backup files must be taken around the same time. If the backup files are out-of-sync, the restore process may be unsuccessful.

## Backing Up and Restoring the Cluster

Cluster backup creates a backup of the entire cluster.

Take note of the following before performing a cluster backup.

- The cluster backup file is typically very large (larger than 1GB).
- Cluster backup cannot be completed successfully if any one of the nodes has less than 50GB of disk space after the backup process.

### Step 1: Back Up the Cluster from the Web Interface

For information on how to back up the cluster from the controller web interface, see [Creating a Cluster Backup](#) on page 341.

### Step 2: Back Up the Cluster from the Controller CLI

Cluster backup creates a backup of the entire cluster.

Follow the steps to back up the cluster from the controller CLI.

1. Log on to the controller CLI as a system administrator.
2. Run the `enable` command to enable privileged mode on the CLI.

```
ruckus> enable
Password: *****
ruckus#
```

3. Run the `show diskinfo` command to determine the current disk size of the node.

To complete the cluster backup successfully, the `/mnt` directory must have at least 50GB (53,687,091,200 in 1K-blocks) of free disk space.

```
ruckus# show diskinfo
Filesystem          1K-blocks      Used Available Use% Mounted on
rootfs              4128448        315520   3603216    9% /
/dev/root           4128448        315520   3603216    9% /
/dev/sda1           2064208         97208   1862144    5% /boot
/dev/mapper/vg00-lv00
41276736 5646756 33533240 15% /mnt
tmpfs               1048576          696   1047880    1% /tmp
tmpfs               3066864           0   3066864    0% /dev/shm
```

4. Run the `backup` command to start the backing up the current cluster.

```
ruckus# backup
Do you want to backup system in this context (yes/no)? yes
Backup process starts.
Backup process has been scheduled to run. You can check backup
version using 'show backup'.
```

5. Run the `show backup` command to verify that the cluster backup file has been created successfully.

### Step 3: Transfer the Cluster Backup File to an FTP Server

1. Log on to the controller **CLI** as a system administrator.
2. Enable privileged mode on the **CLI**.

```
ruckus> enable
Password: *****
ruckus#
```

- Run the `copy backup` command to copy the cluster backup file to an FTP server as shown in the

```
NMS33# copy backup
tftp          Transfer by TFTP
<ftp-url>    FTP directory URL, Format: ftp://<username>:<password>@<ftp-host>[/<dir-path>]

NMS33# copy backup ftp://bala:ruckus@172.19.7.23
Please note that event, alarm and statistic data will not be saved in the exported backup file.

-----
No.   Created on          Patch Version        File Size
-----
1     2015-11-04 05:54:11 GMT  3.4.0.0.108         937.5MB
2     2015-11-16 05:32:53 GMT  3.4.0.0.223         1.2GB
-----

Please choose a backup to send to remote FTP server or 'No' to cancel: 1
Starting to copy the chosen backup to remote FTP server...
Starting to encrypt backup file...
Succeed to copy to remote FTP server
Successful operation

NMS33#
```

**NOTE:** The names of the backup files are automatically assigned by the controller based on the timestamp when the backup file was generated and the controller release version. To make it easy for you to identify the backup files, Ruckus Wireless strongly recommends moving each node's backup file to its own directory on the FTP server (for example, `//ftp/node1`) after the backup process is completed.

#### Step 4: Restoring the Cluster Backup to the Controller

The procedure for restoring the cluster backup to the controller depends on the controller environment – whether it is a single node environment or a multi-node environment.

##### Restoring to a Single Node Environment

The procedure for restoring the cluster backup to the controller depends on the controller environment – whether it is a single node environment or a multi-node environment.

Follow these steps to restore a cluster backup to a single node environment.

- Prepare the new controller to which you will restore the cluster backup.
  - Either obtain a new controller or factory reset an existing controller.
  - Log on to the controller as a system administrator.
  - Run the `setup` command to configure the controller's network settings.

```
ruckus> setup
#####
Start SCG setup process:
#####
:
:
Setup configuration of ethers...
Network would be restarted. You could connect to SCG back by
using Management port (10.2.2.35)!!
Enter "restart network" to continue... restart network
```

2. Transfer the backup file from the FTP server to the controller.
  - a) Log on to the controller **CLI** as a system administrator.
  - b) Run the `enable` command to enable privileged mode on the **CLI**.

```
ruckus> enable
Password: *****
ruckus#
```

- c) Run the `copy <ftp-url> backup` command to transfer the backup file from the FTP server to the controller.

```
ruckus# copy <ftp-url> backup
```

**NOTE:** If there is only one backup file on the FTP server, the system will automatically transfer this file to the controller. If there are multiple files, it will show the list of all available files and you will be prompted to select the file that you want to transfer.

3. Run the `restore local` command to restore the backup file to the controller.

```
ruckus# restore local
This action will REBOOT the system. Do you want to only restore
this SCG node (yes/no)? yes
idx version date
-----
1 1.1.1.0.93 2013-02-01 03:09:27 GMT
2 1.1.1.0.93 2013-02-03 07:21:24 GMT

Please choose a backup version to restore (ex: 1, 2, ...):2
You have completed restoring the backup file to a single node.
```

### Restoring to a Multi Node Environment

If you are restoring to a multi node cluster, you can either replace only one node in the (still-healthy) cluster or replace multiple nodes in the cluster.

#### Replacing a Single Node in a Cluster

Follow these steps to replace a single node in a cluster backup.

1. If the node that you want to replace is still functioning, follow these steps to remove the node.
  - a) Choose a controller that will remain in the cluster.
  - b) Log on to that controller's web interface as an administrator.
  - c) Go to **Configuration > System**.
  - d) On the sidebar, click **Cluster Planes**.
  - e) Locate the node that you want to replace.
  - f) Under the **Actions** column, click the **Delete** button to remove the node from the cluster.
2. If the node that you want to replace is out of service, you will need to shut it down before you can replace it. Follow these steps.
  - a) On the node that you want to replace, log on to the **CLI** as a system administrator.
  - b) Run the `enable` command to enable privileged mode on the **CLI**.

```
ruckus> enable
Password: *****
ruckus#
```

- c) (Optional) Back up the current controller system.  
See [Step 2: Back Up the Cluster from the Controller CLI](#) on page 452.
- d) On the node that you want to replace, run the `shutdown` command.  
`ruckus# shutdown`
- e) Log on to the controller web interface as a system administrator.
- f) Go to **Configuration > System**.
- g) On the sidebar, click **Cluster Planes**.
- h) Locate the node that you want to replace,
- i) Under the **Actions** column, click the **delete** button to remove the node from the cluster.
- j) Set up the node as a new controller, and then join the existing cluster. For step by step instructions, see the *SmartCell Gateway 200 Getting Started Guide*.

### Replacing Multiple Nodes in a Cluster

If the cluster itself is not healthy anymore or if multiple nodes need to be replaced, you must restore backup files taken around the same time to all of the nodes in the cluster.

Follow these steps to restore backups to multiple nodes in a cluster.

**CAUTION:** Backup files must be taken around the same time. If the backup file of one node is out of sync from the others, the restore process will be unsuccessful.

When restoring to multiple nodes, it is critical that you perform the restore process on all nodes at the same time.

Use the `restore local` command to restore the cluster from the backup file as you cannot restore the cluster by using a backup file from another cluster.

1. Log on to the **CLI** as a system administrator.
2. Run the `enable` command to enable privileged mode on the **CLI**.

```
ruckus> enable
Password: *****
ruckus#
```

3. Run the `remote restore` command to transfer the backup file from the FTP server to the controller.

```
ruckus# remote restore {ftp username} {ftp password}
{ftp server address} {(optional) ftp server port} {directory}
idx version date
-----
1 1.1.0.0.207 2012-10-16 06:46:07 GMT
2 1.1.0.0.209 2012-10-17 05:20:51 GMT
Please choose a backup version to get from remote FTP:2
Remote restore process starts
Remote restore process completed
```



**NOTE:** If there is only one backup file on the FTP server, the system will automatically transfer this file to the controller. If there are multiple files, it will show the list of all available files and you will be prompted to select the file that you want to transfer. If the backup files are in the root directory, use "/" in *{directory}*. If the backup files are in a subdirectory, use "{subdir}/{subdir}" to indicate the subdirectory in which the system should check.

4. After all backup files for all nodes have been transferred from the FTP server to the controller, run the `restore local` command to restore the backup file to the controller.

```
ruckus# restore local
This action will REBOOT the system. Do you want to only restore
this SCG node (yes/no)? yes
idx version date
-----
1 1.1.1.0.93 2013-02-01 03:09:27 GMT
2 1.1.1.0.93 2013-02-03 07:21:24 GMT
Please choose a backup version to restore (ex: 1, 2, ...):2
```

5. Verify that the following message appears on each node:

```
Remote restore process completed
```

This indicates that the node is ready for the restore process.

6. Once all nodes are ready for the restore process, run the `restore` command for all nodes at the same time.

## Backing Up and Restoring Configuration

Configuration backup creates a backup of all existing configuration information on the controller. In addition to backing up a different set of information, configuration backup is different from cluster backup in a few ways:

- The configuration backup file is smaller, compared to the cluster backup file.
- The controller can be configured to back up its configuration to an external FTP server automatically.
- Configuration backup does not back up any statistical files or general system configuration.

### Backed Up Configuration Information

The following list shows which configuration information will be backed up.

- AP zones
- AP zone global configuration
- Zone templates
- WLAN templates
- AP registration rules
- Access point information
- General system settings
- Web certificate

- SNMP agent
- Alarm to SNMP agent
- Cluster planes
- Management interface ACL
- Domain information
- User credentials and information
- Mobile Virtual Network Operators (MVNO) information

## Backing Up Configuration

There are two methods you can use to back up the controller configuration:

### Backing Up Configuration from the Web Interface

For information on how to back up the controller configuration to an external FTP server automatically, see [Exporting the Configuration Backup to an FTP Server Automatically](#) on page 353.

### Backing Up Configuration from the CLI

There are two methods you can use to back up the controller configuration either using the web interface or CLI (Command Line Interface).

Follow these steps to back up the controller configuration from the **CLI**.

1. Log on to the controller **CLI** as a system administrator.
2. Run the `enable` command to enable privileged mode on the **CLI**.

```
ruckus> enable
Password: *****
ruckus#
```

3. Run the `backup config` command to start backing up and transferring the node configuration to an FTP server.

```
ruckus# backup config {ftp username} {ftp password}
{ftp server address} {(optional) ftp server port}
Do you want to backup configuration (yes/no)? yes
Backup Configuration process starts
Backup Configuration process has been scheduled to run. You can
check backup version using 'show backup-config'
```

4. Run the `show backup-config` command to verify that the backup file has been created.

You have completed backing up the controller node to an external FTP server.

## Restoring Configuration

### Restoring Configuration to a Single Node Environment

Restoring the configured backup in a single node environment.

Follow the steps below to restore configuration to a single node environment.

1. Prepare the new controller to which you will restore the cluster backup.

- a) Either obtain a new controller or factory reset an existing controller.
- b) Log on to the controller as a system administrator.
- c) Run the setup command to configure the controller's network settings.

```
ruckus> setup
#####
Start SCG setup process:
#####
:
:
Setup configuration of ethers...
Network would be restarted. You could connect to SCG back by
using Management port (10.2.2.35)!!
Enter "restart network" to continue... restart network
```

- d) Complete the controller setup process from the **CLI**.
2. After you complete the controller setup, log on to the controller web interface as a system administrator.
  3. Go to **Administration > Configuration Backup and Restore**.
  4. In the **Configuration Backups** section, click the **Upload** icon.
  5. Browse to the location (either on the local computer or on the network) of the configuration backup file that you want to restore.
  6. Select the configuration backup file, and then click **Upload**.
- When the upload process is complete, the backup file appears in the **Configuration Backups** section.
7. Restore the configuration backup file to the node, either using the web interface or the **CLI**.
  8. To use the web interface:
    - a) On the web interface, go to **Administration > Configuration Backup and Restore**.
    - b) In **Configuration Backups**, locate the configuration backup file that you want to restore, and then click the restore icon that is in the same row.
    - c) Follow the prompts (if any) to complete the restore process.
  9. To use the **CLI**:
    - a) Log on to the **CLI** as a system administrator.
    - b) Run the `restore config` command.

```
ruckus# restore config
This action will REBOOT the system. Do you want to only restore
this SCG node (yes/no)?yes
idx version date
-----
1 1.1.1.0.93 2013-02-01 03:09:27 GMT
2 1.1.1.0.93 2013-02-03 07:21:24 GMT
Please choose a backup version to restore (ex: 1, 2, ...):2
```

- c) Follow the prompts (if any) to complete the restore process.

You have completed restoring the configuration to a single node controller.

## Restoring Configuration to Multi Node Environment

If you are restoring to a multi node cluster, you can either replace only one node in the (still-healthy) cluster or replace multiple nodes in the cluster.

### Restoring Configuration to a Single Node in a Cluster

Follow these steps to replace the configuration of a single node in a cluster.

1. If the node that you want to replace is still functioning, follow these steps to remove the node.
  - a) Choose a controller that will remain in the cluster.
  - b) Log on to that controller's web interface as an administrator.
  - c) Go to **Configuration > System**.
  - d) On the sidebar, click **Cluster Planes**.
  - e) Locate the node that you want to replace.
  - f) Under the **Actions** column, click the delete button to remove the node from the cluster.
2. If the node that you want to replace is out of service, you will need to shut down the node before you can replace it. Follow these steps.
  - a) On the node that you want to replace, log on to the **CLI** as a system administrator.
  - b) Run the enable command to enable privileged mode on the **CLI**.

```
ruckus> enable
Password: *****
ruckus#
```

- c) (Optional) Back up the current controller system.  
See [Step 2: Back Up the Cluster from the Controller CLI](#) on page 452.
- d) On the node that you want to replace, run the `shutdown` command.  

```
ruckus# shutdown
```
- e) Log on to the controller web interface as a system administrator.
- f) Go to **Configuration > System**.
- g) On the sidebar, click **Cluster Planes**.
- h) Locate the node that you want to replace,
- i) Under the **Actions** column, click the **delete** button to remove the node from the cluster.
- j) Set up the node as a new controller, and then join the existing cluster. For step by step instructions, see the SmartCell 200 Getting Started Guide.

You have completed restoring configuration to a single node in the cluster.

### Restoring Configuration to Multiple Nodes in a Cluster

If the cluster itself is not healthy anymore or if multiple nodes need to be replaced, you must factory reset all remaining nodes to ensure that configuration restore to the cluster will be successful.

Follow the steps to restore the configuration to multiple nodes in a cluster.

1. Prepare the new controller nodes and factory reset all of the existing nodes in the cluster.
2. Complete the setup procedure for one of the controller nodes.

For instructions, see the SmartCell Gateway 200 Getting Started Guide for this release.

3. After you complete the setup of one node, log on to the web interface of that node as a system administrator.
4. Go to **Administration > Configuration Backup and Restore**.
5. In the **Configuration Backups** section, click the **upload** icon.
6. Locate the configuration backup file that you want to restore.
7. Click **Upload**.

After the configuration file is uploaded successfully, it appears in the **Configuration Backups** section.

8. Restore the configuration backup to the node either using the web interface or the CLI.
9. To use the web interface:
  - a) Go to **Administration > Configuration Backup and Restore** page.
  - b) In the **Configuration Backups** section, locate the configuration backup file that you want to restore.
  - c) Click the restore icon that is in the same row.
  - d) Follow the prompts (if any) to complete the restore process.
10. To use the **CLI**:
  - a) Log on to the **CLI** of the node as a system administrator.
  - b) Run the `restore config` command.

```
ruckus# restore config
This action will REBOOT the system. Do you want to only restore
this SCG node (yes/no)?yes
idx version date
-----
1 1.1.1.0.93 2013-02-01 03:09:27 GMT
2 1.1.1.0.93 2013-02-03 07:21:24 GMT
Please choose a backup version to restore (ex: 1, 2, ...):2
```

- c) When the configuration restore process on this node is complete, set up the next node and configure it to join the existing cluster.

You have completed restoring configuration backup to multiple nodes in a cluster.

## Appendix



# SCG SSID Syntax

In this chapter:

- [SSIDs Supported in Release 1.1.x](#)
- [SSIDs Supported in Release 2.1.x](#)
- [SSIDs Supported in Release 2.5.x](#)
- [SSIDs Supported in Release 3.0 and Above](#)
- [ZoneDirector SSID Syntax](#)
- [ZoneFlex AP SSID Syntax](#)

The following sections describe the supported SSID syntax in the following SCG release versions:

## SSIDs Supported in Release 1.1.x

Release 1.1.x supports a specific set of SSID syntaxes, which may be different from the syntaxes supported in other releases.

[Table 49: Supported SSID syntaxes in 1.1.x](#) on page 462 describes the SSID syntaxes that are supported in release 1.1.x.

**Table 49: Supported SSID syntaxes in 1.1.x**

Web Interface	Length	Between 1 and 32 characters, including characters from printable characters (ASCII characters space (32) to ~ (126))
	Supported Characters	<ul style="list-style-type: none"> <li>• A-Z</li> <li>• a-z</li> <li>• 0-9</li> <li>• _space_!"#\$%&amp;'()*+,-./</li> <li>• ;;&lt;=?@</li> <li>• [ ] ^ _ `</li> <li>• { }</li> </ul>
CLI	Length	Unsupported
	Supported Characters	Unsupported

## SSIDs Supported in Release 2.1.x

Release 2.1.x supports a specific set of SSID syntaxes, which may be different from the syntaxes supported in other releases.

**Table 50: Supported SSID syntaxes in 2.1.x**

Web Interface	Length	Between 1 and 32 characters, including characters from printable characters (ASCII characters space (32) to ~(126)
	Supported Characters	<ul style="list-style-type: none"> <li>• A-Z</li> <li>• a-z</li> <li>• 0-9</li> <li>• _space_!"#\$%&amp;'()*+,-./</li> <li>• ;;&lt;=?@</li> <li>• [ ] ^ _ `</li> <li>• { }</li> </ul>
CLI	Length	Between 2 and 32 characters
	Supported Characters	All characters, but the space character cannot be the first or last character in the SSID

## SSIDs Supported in Release 2.5.x

Release 2.5.x supports a specific set of SSID syntaxes, which may be different from the syntaxes supported in other releases.

**Table 51: Supported SSID syntax in 2.5.x**

Web Interface	Length	Between 1 and 32 characters, including characters from printable characters (ASCII characters space (32) to ~ (126)
	Supported Characters	<ul style="list-style-type: none"> <li>• A-Z</li> <li>• a-z</li> <li>• 0-9</li> <li>• _space_!"#\$%&amp;'()*+,-./</li> <li>• ;;&lt;=?@</li> <li>• [ ] ^ _ `</li> <li>• { }</li> </ul>
CLI	Length	Between 2 and 32 characters
	Supported Characters	All characters

## SSIDs Supported in Release 3.0 and Above

Release 3.0 and above supports a specific set of SSID syntaxes, which may be different from the syntaxes supported in other releases.

**Table 52: Supported SSID syntax in 3.0 and above**

Web Interface and CLI	Length	Between 2 to 32 characters are supported
	Characters	<p>Unsupported: ` and \$(</p> <p>Space is allowed, but it must include at least one non-space character (" abc" is valid, however only space such as " " is invalid).</p> <p><b>NOTE:</b> One Chinese word is regarded as three special characters.</p>

## ZoneDirector SSID Syntax

The following sections describe the supported SSID syntax in the following SCG release version:

### SSIDs Supported in Releases 9.8 and 9.7

ZoneFlex releases 9.8 and 9.7 support a specific set of SSID syntaxes, which may be different from the syntaxes supported in other releases.

**Table 53: Supported SSID syntaxes in ZoneFlex 9.8 and 9.7**

Web Interface	Length	Between one and 32 characters
	Supported Characters	All printable ASCII characters from space (32) to ~(126)
	Exceptions	<p>The space character (32) cannot be the first or last character in the SSID. Otherwise, the following error message appears:</p> <p>can only contain between 1 and 32 characters, including characters from ! (char 33) to ~ (char 126).</p>
CLI	Length	Between one and 32 characters
	Supported Characters	All printable ASCII characters from space (32) to ~(126)
	Exceptions	The space character (32) can be placed anywhere in the SSID (including the beginning or end)



		provided that it enclosed by a double quotation mark.
--	--	-------------------------------------------------------

## Supported SSIDs in ZoneFlex Release 9.6

ZoneFlex release 9.6 supports a specific set of SSID syntaxes, which may be different from the syntaxes supported in other releases.

**Table 54: Supported SSID syntaxes in ZoneFlex 9.6**

Web Interface	Length	Between two and 32 characters
	Supported Characters	All printable ASCII characters from space (32) to ~(126)
	Exceptions	The space character (32) cannot be the first or last character in the SSID. Otherwise, the following error message appears:  can only contain between 1 and 32 characters, including characters from ! (char 33) to ~ (char 126).
CLI	Length	Between two and 32 characters
	Supported Characters	All printable ASCII characters from space (32) to ~ (126)
	Exceptions	The space character (32) can be placed anywhere in the SSID (including the beginning or end) provided that it enclosed in a double quotation mark (for example, "Ruckus Wireless SSID").

## ZoneFlex AP SSID Syntax

The following sections describe the supported SSID syntax in the following ZoneFlex AP release versions:

### Supported SSIDs in Releases 9.8, 9.7, and 9.6

ZoneFlex release 9.8, 9.7, and 9.6 support a specific set of SSID syntaxes, which may be different from the syntaxes supported in other releases.

**Table 55: Supported SSID syntaxes in ZoneFlex AP 9.8, 9.7, and 9.6**

Web Interface	Length	Between one and 32 characters
	Supported Characters	All printable ASCII characters from space (32) to ~(126)
CLI	Length	Between one and 32 characters

Supported Characters	All printable ASCII characters from space (32) to ~ (126)
Exceptions	<p>The space character (32) can be placed anywhere in the SSID (including the beginning or end) provided that it enclosed in a double quotation mark (for example, "Ruckus Wireless SSID").</p> <p>If the space character is not enclosed in a double quotation mark, the space character and any characters after that will be ignored. For example, if you run the command "set ssid wlan0 ruckus-ap 123", the controller CLI will run the command as "set ssid wlan0 ruckus-ap 123".</p>

# Index

## A

- access point [292](#)
  - rebooting [292](#)
  - restarting remotely [292](#)
- access points [287](#), [290–291](#)
  - downloading support log [291](#)
  - exporting to CSV [290](#)
  - monitoring [287](#)
  - viewing a summary [287](#)
  - viewing configuration [290](#)
- account [396](#)
- accounting profile [392](#)
- acknowledge [304](#)
- administrative tasks [352](#), [356–357](#)
- backup [352](#)
  - deleting [357](#)
  - backup [357](#)
- restore [356](#)
- administrator accounts [247](#)
- administrator activity [311–313](#)
  - exporting to CSV [313](#)
  - filtering [312](#)
- administrator password [29](#)
  - changing [29](#)
- advanced [398](#)
- alarms [304–306](#), [309](#)
  - exporting to CSV [306](#)
  - filtering [305](#), [309](#)
  - viewing [304](#)
- ap certificates [371–372](#), [375](#), [378](#)
  - confirming status [378](#)
  - exporting [372](#)
  - importing [375](#)
  - managing [371](#)
  - replacing [371](#)
  - viewing [372](#)
- ap patch files [366](#)
- uploading [366](#)
- AP rebalancing [221](#)
- ap snmp options [54](#)
- AP status summary [24](#)
- AP zone [283](#), [285–287](#)
  - exporting to CSV [285](#)
  - monitoring [283](#)
  - viewing a summary [283](#)
  - viewing configuration [286](#)
  - viewing on Google Maps [287](#)
- apn resolution [387](#)
- authentication [398](#)
- authentication profile [389](#)

## B

- backing up [345](#)
  - FTP [345](#)
- backup [352](#), [356–357](#)
  - deleting [357](#)
  - restoring [356](#)

## C

- Captive Portal [267](#)
- client admission control [53](#)
  - Client admission control allows APs to adaptively allow or deny the association of clients based on the potential throughput of the currently associated clients. This helps prevent APs from becoming overloaded with clients and improves user experience for wireless users. [53](#)
- client count summary [23](#)
- client number report [315](#)
- client OS type summary widget [24](#)
- common settings [394](#)
- communication ports [430](#)
- content area [22](#)
- continuously disconnected APs report [316](#)
- controller [389](#)
- copyright information [14](#)
- creating [279](#), [316](#)
- hotspot [279](#)
- report [316](#)

## D

- DC power supply [449](#)
- default apn settings [394](#)
- deleting [321](#)
  - report [321](#)
- dhcp discover [386](#)
- DHCP Option 43 [108](#)
- dhcp relay [394](#)
- DHCP relay [189](#), [195](#), [394](#)
- dhcp43 [108](#)
- dns override [188](#)
- dns server service [188](#)
  - creating [188](#)
  - dns server services [188–189](#)
  - deleting [189](#)
  - viewing [188](#)
- dns servers [387](#)
- domain summary [24](#)
- downloading [369](#)
  - system logs [369](#)
- dynamic psk [97–98](#)
- generating [98](#)
- importing [98](#)

dynamic psk *(continued)*  
viewing [97](#)

## E

electrostatic discharge [449](#)  
Ethernet port profiles [96](#)  
important notes [96](#)  
exporting [285](#), [290](#), [306](#)  
access points [290](#)  
alarms [306](#)  
AP zones [285](#)  
external portal [401](#)

## F

filtering [305](#)  
alarms [305](#)  
firewall ports [430](#)  
Follow these steps to create a new report. [316](#)  
forwarding policy per realm [394](#)  
forwarding profile [394](#), [398](#)  
friendly name [389](#)  
front bezel [443](#), [448](#)  
reinstalling [448](#)  
removing [443](#)  
FRU [443](#)  
hard disk [443](#)  
FTP servers [166](#)

## G

Google Maps [287](#)  
grounding cable [449](#)  
guest access [396](#)

## H

hard disk drive carrier [444](#)  
hard drives [443](#)  
installing [443](#)  
HDD replacement [443](#)  
health check policy [389](#), [392](#)  
hotspot [279](#)  
creating [279](#)  
hotspot portal [396](#), [398](#)

## I

identifiers [386](#)  
installing [443](#)  
hard drive [443](#)  
IPSec [104](#)

## L

legal [14](#)

license [379](#), [381](#), [383](#), [385](#)  
importing [383](#)  
managing [379](#)  
summary [381](#)  
synchronizing [385](#)  
server [385](#)  
licenses [381](#), [384](#)  
downloading [384](#)  
viewing [381](#)  
LLDP [50](#)  
attributes [50](#)  
location information [396](#)  
logging off [30](#)  
logging on [19](#)  
logon page [19](#)  
logon url [396](#)

## M

main menu [21](#)  
management port number [19](#)  
management protocol [387](#)  
mesh role [287](#)  
miscellaneous bar [22](#)  
monitoring [283](#), [287](#)  
access points [287](#)  
AP zones [283](#)

## N

network connectivity [293](#)  
no response fail [389](#), [392](#)

## P

packet core [386](#)  
patch file [360](#)  
payload [387](#)  
ping [293](#)  
portal authentication [401](#)  
ports to open [430](#)  
power supply unit [449](#)  
primary server [389](#), [392](#)  
PSU [449](#)

## R

RADIUS [403](#)  
access accept messages [403](#)  
rate limiting [79](#), [389](#), [392](#)  
device policies [79](#)  
user traffic profile [79](#)  
rebooting access point [292](#)  
reconnects [386](#)  
redirection [396](#)  
registered users [396](#)  
removing [443](#)  
front bezel [443](#)

- renewing [374](#)
- ap certificate [374](#)
- replacement hard disk [443](#)
- replacing [443](#), [449](#)
- hard drive [443](#)
- power supply unit [449](#)
- system fan [449](#)
- report notification [319](#)
- report schedule [319](#)
- reports [315–316](#), [319–321](#)
- client number [315](#)
- continuously disconnected APs [316](#)
- creating [316](#)
- deleting [321](#)
- email notifications [319](#)
- system resource utilization [316](#)
- TX/RX bytes [316](#)
- types [315](#)
- viewing list [320](#)
- response window [389](#), [392](#)
- restarting access point [292](#)
- restoring [347](#), [356](#)
- backup [356](#)
- FTP [347](#)
- revive interval [389](#), [392](#)
- RFC 2132 [108](#)
- role [247](#)
- assigning administrator accounts [247](#)

## S

- secondary server [389](#), [392](#)
- service protocol [389](#), [392](#)
- session identifier [387](#)
- sidebar [22](#)
- smart client support [396](#)
- snapshot [370](#)
- software upgrade file [360](#)
- start page [396](#)
- submenu [22](#)
- Subscriber Portal [267](#)
- support log [291](#)
- supported web browsers [19](#)
- system fan [449](#)
- system logs [367](#), [369](#)
- available logs [367](#)
- downloading [369](#)
- system resource utilization report [316](#)
- system summary [24](#)

## T

The Link Layer Discovery Protocol (LLDP) is a vendor-neutral Layer 2 protocol that allows a network device (for example, a Ruckus Wireless AP) to advertise its identity and capabilities on the local network. [50](#)

To delete multiple RADIUS services simultaneously, follow these steps: [159](#)

traceroute [293](#)

- trademarks [14](#)
- ttg establishment [386](#)
- tunnel control [387](#)
- tunnel establishment [402](#)
- tunnel terminating gateway [387](#)
- tunnel traffic [387](#)
- tunneling [386](#), [398](#)
- TX/RX bytes report [316](#)

## U

- user session [396](#)
- user traffic [386](#)

## V

- verifying upgrade [364](#)
- viewing [283](#), [304](#)
- alarms [304](#)
- AP zones [283](#)
- VSAs [403](#)

## W

- walled garden [267](#), [396](#)
- Web browser [19](#)
- Web interface [19–20](#), [30](#)
- features [20](#)
- logging off [30](#)
- logging on [19](#)
- widget slot [27](#)
- widget slots [24](#)
- widgets [23–28](#)
- adding a widget to a widget slot [26](#)
- adding to the dashboard [25](#)
- AP status summary [24](#)
- available slots [24](#)
- available widgets [23](#)
- client count summary [23](#)
- client OS type summary [24](#)
- data throughput summary [24](#)
- deleting [28](#)
- displaying a widget in a widget slot [27](#)
- domain summary [24](#)
- moving to another slot [28](#)
- system summary [24](#)
- wireless clients [294](#), [296–297](#)
- exporting to CSV [296](#)
- monitoring [294](#)
- viewing information [297](#)
- viewing summary [294](#)
- wlan [78](#)
- portal-based [78](#)
- types [78](#)
- wlan usage [398](#)

## Z

zombie period [389](#), [392](#)

zone template [396](#)